



MaxTrak™ 180 Modbus

Instruction Manual

Modbus Device Specification for MaxTrak™ 180
Industrial Mass Flow Meters & Controllers



Part Number: IM-180ModbusRev.V1
May 2013



SIERRA[®]
EXPERIENCE OUR PASSION FOR FLOW!

GLOBAL SUPPORT LOCATIONS: WE ARE HERE TO HELP!

CORPORATE HEADQUARTERS

5 Harris Court, Building L Monterey, CA 93940
Phone (831) 373-0200 (800) 866-0200 Fax (831) 373-4402
www.sierrainstruments.com

EUROPE HEADQUARTERS

Bijlmansweid 2 1934RE Egmond aan den Hoef
The Netherlands
Phone +31 72 5071400 Fax +31 72 5071401

ASIA HEADQUARTERS

Second Floor Building 5, Senpu Industrial Park
25 Hangdu Road Hangtoun Town
Pu Dong New District, Shanghai, P.R. China
Postal Code 201316
Phone: + 8621 5879 8521 Fax: +8621 5879 8586

IMPORTANT CUSTOMER NOTICE: OXYGEN SERVICE

Sierra Instruments, Inc. is not liable for any damage or personal injury, whatsoever, resulting from the use of Sierra Instruments standard mass flow meters or controllers for oxygen gas. You are responsible for determining if this mass flow meter or controller is appropriate for your oxygen application. You are responsible for cleaning the mass flow meter or controller to the degree required for your oxygen flow application.

© COPYRIGHT SIERRA INSTRUMENTS 2013

No part of this publication may be copied or distributed, transmitted, transcribed, stored in a retrieval system, or translated into any human or computer language, in any form or by any means, electronic, mechanical, manual, or otherwise, or disclosed to third parties without the express written permission of Sierra Instruments. The information contained in this manual is subject to change without notice.

TRADEMARKS

MaxTrak™, MaxTrak 180 Modbus™, Smart-Trak®, and Dial-A-Gas® are trademarks of Sierra Instruments, Inc. Other product and company names listed in this manual are trademarks or trade names of their respective manufacturers.

Warnings and Cautions

Note and Safety Information

We use caution and warning statements throughout this book to draw your attention to important information.



Warning!

This statement appears with information that is important to protect people and equipment from damage. Pay very close attention to all warnings that apply to your application.



Caution! / Note!

This statement appears with information that is important for protecting your equipment and performance. Read and follow all cautions that apply to your application.



Warning! Agency approval for hazardous location installations varies between flow meter models. Consult the flow meter nameplate for specific flow meter approvals before any hazardous location installation.

Warning! All wiring procedures must be performed with the power off.

Warning! To avoid potential electric shock, follow National Electric Code safety practices or your local code when wiring this unit to a power source and to peripheral devices. Failure to do so could result in injury or death. All AC power connections must be in accordance with published CE directives.

Warning! Do not power the flow meter with the sensor remote (if applicable) wires disconnected. This could cause over-heating of the sensors and/or damage to the electronics.

Warning! Before attempting any flow meter repair, verify that the line is de-pressurized.

Warning! Always remove main power before disassembling any part of the mass flow meter/controller.



Caution! Before making adjustments to the device, verify the flow meter/controller is not actively monitoring or reporting to any master control system. Adjustments to the electronics will cause direct changes to flow control settings.

Caution! When using toxic or corrosive gases, purge the line with inert gas for a minimum of four hours at full gas flow before installing the meter.

Caution! The AC wire insulation temperature rating must meet or exceed 80°C (176°F).

Caution! Printed circuit boards are sensitive to electrostatic discharge. To avoid damaging the board, follow these precautions to minimize the risk of damage:

- before handling the assembly, discharge your body by touching a grounded, metal object
- handle all cards by their edges unless otherwise required
- when possible, use grounded electrostatic discharge wrist straps when handling sensitive components

Receipt of System Components

When receiving a Sierra mass flow meter, carefully check the outside packing carton for damage incurred in shipment. If the carton is damaged, notify the local carrier and submit a report to the factory or distributor. Remove the packing slip and check that all ordered components are present. Make sure any spare parts or accessories are not discarded with the packing material. Do not return any equipment to the factory without first contacting Sierra Customer Service.

Technical Assistance

If you encounter a problem with your flow meter, review the configuration information for each step of the installation, operation, and setup procedures. Verify that your settings and adjustments are consistent with factory recommendations. Installation and troubleshooting information can be found in the MaxTrak 180 Series manual.

If the problem persists after following the troubleshooting procedures outlined in the MaxTrak 180 Series manual, contact Sierra Instruments by fax or by E-mail (see inside front cover). For urgent phone support you may call (800) 866-0200 or (831) 373-0200 between 8:00 a.m. and 5:00 p.m. PST. In Europe, contact Sierra Instruments Europe at +31 (0)72-5071400. In the Asia-Pacific region, contact Sierra Instruments Asia at +86-21-58798521. When contacting Technical Support, make sure to include this information:

- The flow range, serial number, and Sierra order number (all marked on the meter nameplate)
- The software version (visible at start up)
- The problem you are encountering and any corrective action taken
- Application information (gas, pressure, temperature and piping configuration)

Table of Contents

- Table of Contents 5**
- Chapter 1: Introduction 7**
- Chapter 2: Electrical Connections 8**
 - Pin Configuration 8
 - RS-485 Connection 9
 - Connection 9
 - General 2-Wire Topology RS-485 9
 - Line Polarization 10
 - Analog Inputs 10
 - Connection 10
- Chapter 3: Communicating 11**
 - Power Up 11
 - Data Format Various Registers 11
 - Modbus Registers Overview 12
 - Special – Modbus Set Up 14
 - Registers Explained 14
 - Register Descriptions 14
 - 40001: Actual Flow 14
 - 40003: Set Point 14
 - 40005 – 40008: Totalizer 14
 - 40009: Valve Power 14
 - 40010 - 40011: Analog Inputs 1 & 2 15
 - 40012: Alarm Status 15
 - 40013: Factory Full Scale 15
 - 40015: User Full Scale 15
 - 40017: Gas Span 15
 - 40019 - 40022: Trigger Point Alarm 15
 - 40023: Alarm Control Register 15
 - 40024: Trigger Source Alarm 15
 - 40025: Analog Input Settings 15
 - 40026: Gas Index 15
 - 40027: Valve Position Index 15
 - 40028: Flow Unit Index 16
 - 40029: Password 16
 - 40030: Input Set Point Index 16
 - 40031: Analog Output Index 17
 - 40032: Firmware Revision 17
 - 40034: Device Type 17
 - 40032 - 40038: Serial Number 17
 - 40039 - 40043: Tag 17
 - 40044 – 40051: Gas Name 1 17
 - 40052 – 40059: Gas Name 2 17
 - 40060 – 40067: Gas Name 3 17
 - 40068 – 40075: Gas Name 4 17
 - 40076 – 40083: Gas Name 5 17
 - 40084 – 40091: Gas Name 6 17
 - 40092 – 40099: Gas Name 7 17
 - 40100 – 40107: Gas Name 8 17
 - 40108 – 40115: Gas Name 9 17
 - 40116 – 40123: Gas Name 10 17
 - 40124: Sensor Data 17
 - 40125: Set Unit To Zero 18

40126: Reset Unit To Factory Default.....	18
Special Modbus Set Up Registers	18
44100: Id.....	18
44101: Baud Rate.....	18
44102: Parity.....	18
44103: TX Delay.....	18
44104: Reset Unit.....	18
Chapter 4: Alarm System.....	19
Alarm Principle	19
Alarm Control Register (40023)	19
Trigger Source (40024).....	20
Trigger Point (level).....	20
Alarm Status Register	20
Chapter 5: Bootloader.....	21
Introduction.....	21
Getting started.....	21
Load Firmware.....	22
Setup Firmware.....	24
Quit	24
Trouble Shooting	25

Chapter 1: Introduction

The MaxTrak 180 with add-on module for Sierra Instruments' MaxTrak 180 gas flow measurement and control instruments.

A variety of features enable the integration of the MaxTrak into a Modbus network environment.

Among these features:

- Access to all vital data
- Sophisticated alarm system
- Totalizer
- Pulse output
- Analog inputs
- MaxTrak functionality monitor



Important Tip!

To fully understand the MaxTrak 180 Modbus and its functions, it is recommended that you also read the MaxTrak 180 instruction manual.

Chapter 2: Electrical Connections

All electrical connections are made on the terminal board. There are two screw terminals which give access to input power, network interface and other options.

Pin Configuration

Terminal board overview:

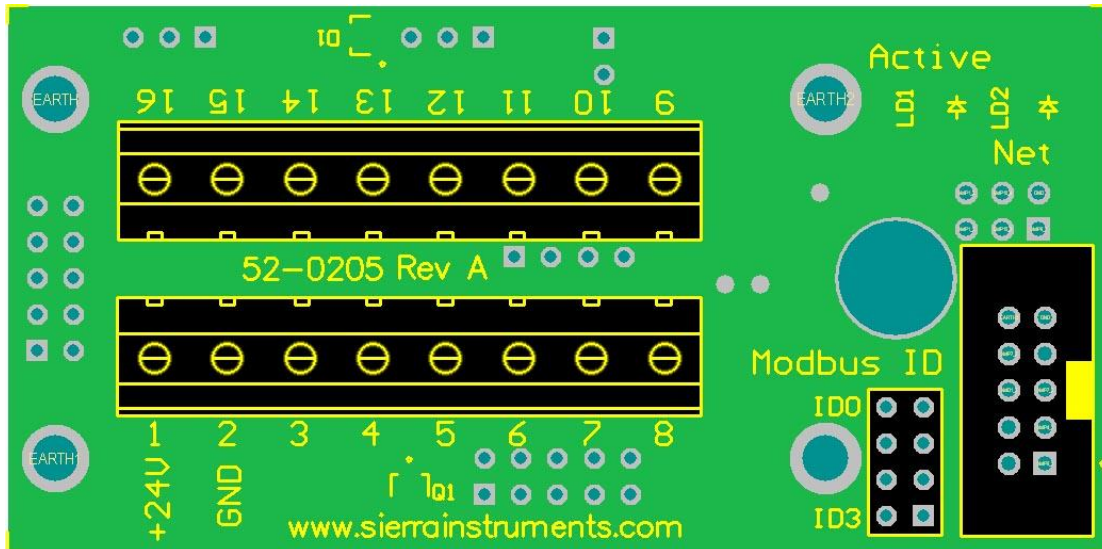

Figure 1: Terminal board overview

Pin layout:

Pin	Function
1	+24V Power
2	Ground
3	Earth
4	Set point input
5	4-20mA output
6	Alarm output
7	Analog channel 1
8	Analog channel 2

Pin	Function
9	Note 1
10	Note 1
11	RS-232 -RX (in)
12	RS-232 -TX (out)
13	Ground
14	RS-485 - A
15	RS-485 - B
16	RS-485 Shield

During power-up or reset the Modbus ID pins are scanned. These pins set the Modbus ID code.

ID3	ID2	ID1	ID0	Modbus ID
open	open	open	open	Internal ID
open	open	open	closed	1
open	open	closed	open	2
open	open	closed	closed	3
-	-	-	-	
closed	closed	closed	closed	15

(Place jumper to enable)

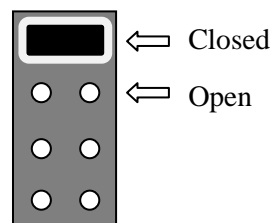

	<p>Note The terminal connections are used for optional interfaces (HART) which can be added. Please contact Sierra Instruments for more information.</p>
--	---

RS-485 Connection

Connection

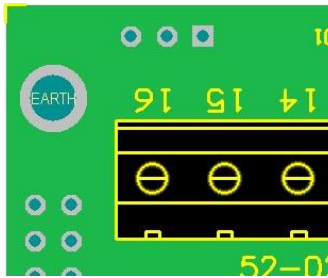

Pin 14 = RS-485 – A

Pin 15 = RS-485 – B

Pin 16 = RS-485 – Shield



Caution!

The MaxTrak 180 Modbus is equipped with an optical isolated RS-485 interface. Don't connect the RS-485 shield to the ground of the power supply unless the isolated barrier isn't required.

General 2-Wire Topology RS-485

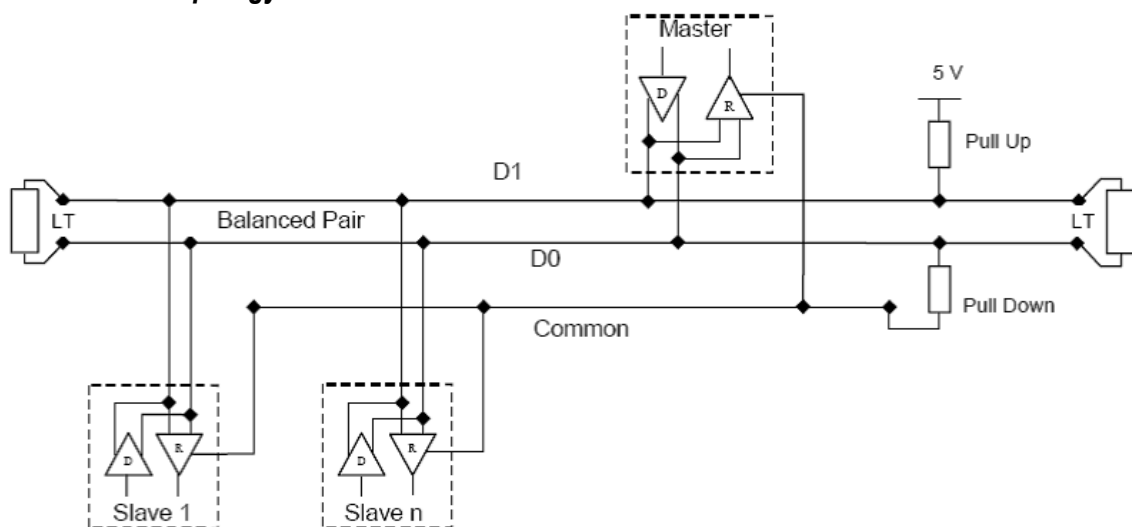

Figure 2: General 2-Wire Topology RS-485 Network

The “RS-485 –A” (also referred as ‘-’) is connected with the D0 line. The “RS-485 –B” (also referred as ‘+’) is connected with the D1 line. The shield is connected to the common line of the network.

A maximum of 32 devices is authorized on an RS-485 system without the need of a repeater.

Cable

It is recommended to use a twisted pair type of cable (reduces radiated and received EMI). Category 5 cables may be used to a maximum length of 600 meters. To operate at cable lengths of 1000 meter it is advised to use AWG 26 or lower.

Terminator

Reflections in a transmission line can cause communication errors. To minimize the reflection it is required to place terminator resistors at both ends of the cable. Never place a terminator resistor somewhere along the cable. The use of line terminators depends on cable lengths and should be determined on site. Typical values for terminator resistors are 150 ohm (0.5 W).

Line Polarization

In noise environments it may be necessary to polarize the lines to ensure that the receivers stay in a constant state when no signal is present. The polarization must be implemented at one location for the whole bus. The value for the pull up and pull down resistors is between 450 and 650 ohms (a higher value permits more devices to be connected to the bus).

Analog Inputs

The analog inputs can be used to connect various transducers (temperature, pressure etc.). Maximum input range is 0-10 Vdc or 0-40 mA. Various options can be set through the Modbus control register (40025).

Connection

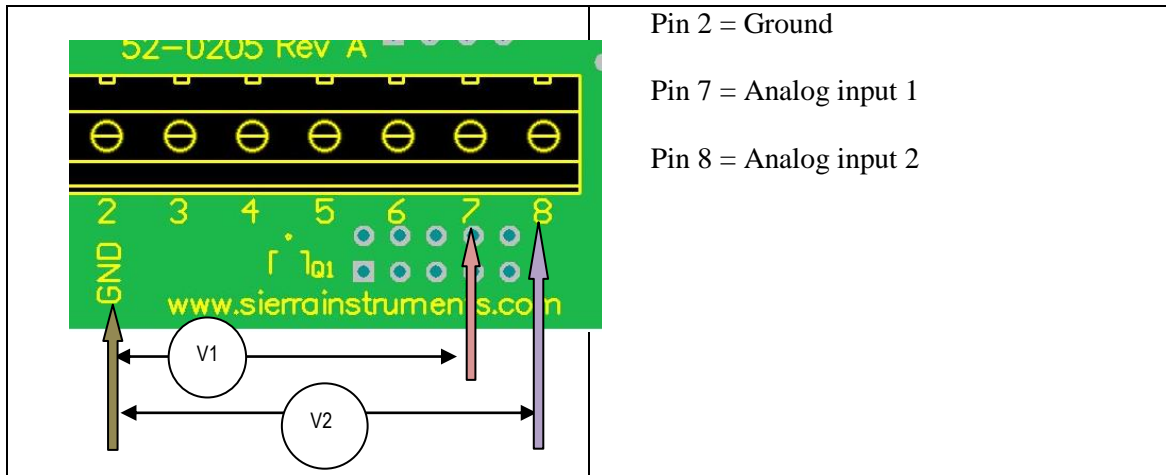

Chapter 3: Communicating

Once the MaxTrak 180 Modbus is wired to the network and powered up it is time to communicate with it. The settings for the Modbus interface are as following:

- ID code = 255 (or 1 – 15 depending on the ID pin settings)
- Baud rate = 19200
- Parity = Even
- Number of bits = 8
- Stop bit = 1
- Delay between receiving and transmitting = 2 ms

The above settings are factory defaults and can be changed. Changing the settings can be done through the boot loader or special registers.

Power Up

When powering up the red LED (labeled: Net) will light up after 2 seconds indicating the initialization phase. During this time data is retrieved from the 180 and stored into the MaxTrak 180 Modbus memory. There is no communication through Modbus possible at this stage.

Once all data is retrieved the red LED goes off and the green LED (labeled: Active) will start blinking as it receives data from the instrument. Communication through Modbus is possible now.

If the communication with the instrument is lost for some reason, the MaxTrak 180 Modbus will try to establish it again. During this phase the Modbus interface will not be active.

The red LED will light up every time a network message is received with the correct ID code.



Data Format Various Registers

- 32 bit real: IEEE 754 floating point, low word first
- BCD encoded: hex encoded decimal values f.i. 0x89 = decimal 89
- 8 & 16 bits int: unsigned integer values
- 16 bits ASCII: ASCII encoded characters, high word = 1st character. 0x4944 = “ID”

Modbus Registers Overview

PDU Address	Register	Description	Read/Write	Data Type	No. Registers
Dynamic Data					
\$00	40001	Actual flow - low word	R	32 bits real	2
\$01	40002	Actual flow - high word			
\$02	40003	Set point - low word	R/W	32 bits real	2
\$03	40004	Set point - high word			
\$04	40005	Totalizer3,4	R/W (Reset)	BCD encoded	4
\$05	40006	Totalizer1,2	R		
\$06	40007	Totalizer7,8	R		
\$07	40008	Totalizer5,6	R		
\$08	40009	Valve power	R	16 bits int.	1
\$09	40010	Analog CH0	R	16 bits int.	1
\$0A	40011	Analog CH1	R	16 bits int.	1
\$0B	40012	Alarm status	R/W	16 bit int.	1
Settings					
\$0C	40013	Factory f.s – low word	R	32 bits real	2
\$0D	40014	Factory f.s – high word			
\$0E	40015	User f.s – low word	R/W	32 bits real	2
\$0F	40016	User f.s – high word			
\$10	40017	Gas span – low word	R/W	32 bits real	2
\$11	40018	Gas span – high word			
\$12	40019	Trigger low – low word	R/W	32 bits real	2
\$13	40020	Trigger low – high word			
\$14	40021	Trigger high – low word	R/W	32 bits real	2
\$15	40022	Trigger high – high word			
\$16	40023	Alarm Control register	R/W	16 bit int.	1
\$17	40024	Trigger source 1	R/W	16 bit int.	1
\$18	40025	Analog input setting	R/W	8 bits int.	1
\$19	40026	Gas index	R/W	8 bits int.	1
\$1A	40027	Valve position index	R/W	8 bits int.	1
\$1B	40028	Flow unit index	R/W	8 bits int.	1
\$1C	40029	Password	R/W	16 bits int.	1
\$1D	40030	Input set point index	R/W	8 bits int.	1
\$1E	40031	Analog output index	R/W	8 bits int.	1

Static Data

\$1F	40032	Device firm rev – low word	R	32 bits real	2
\$20	40033	Device firm rev – high word			
\$21	40034	Device type	R	16 bits ASCII	1
\$22	40035	Serial number – char 1,2	R	16 bits ASCII	4
\$23	40036	Serial number – char 3,4			
\$24	40037	Serial number – char 5,6			
\$25	40038	Serial number – char 7,8			
\$26	40039	Tag number - char 1,2	R	16 bits ASCII	5
\$27	40040	Tag number - char 3,4			
\$28	40041	Tag number - char 5,6			
\$29	40042	Tag number - char 7,8			
\$2A	40043	Tag number - char 9,10			
\$2B	40044	Gas 1 – char 1,2	R	16 bits ASCII	8
~					
\$32	40051	Gas 1 – char 15,16			
\$33	40052	Gas 2 – char 1,2	R	16 bits ASCII	8
~					
\$3A	40059	Gas 2 – char 15,16			
\$3B	40060	Gas 3 – char 1,2	R	16 bits ASCII	8
~					
\$42	40067	Gas 3 – char 15,16			
\$43	40068	Gas 4 – char 1,2	R	16 bits ASCII	8
~					
\$4A	40075	Gas 4 – char 15,16			
\$4B	40076	Gas 5 – char 1,2	R	16 bits ASCII	8
~					
\$52	40083	Gas 5 – char 15,16			
\$53	40084	Gas 6 – char 1,2	R	16 bits ASCII	8
~					
\$5A	40091	Gas 6 – char 15,16			
\$5B	40092	Gas 7 – char 1,2	R	16 bits ASCII	8
~					
\$62	40099	Gas 7 – char 15,16			
\$63	40100	Gas 8 – char 1,2	R	16 bits ASCII	8
~					
\$6A	40107	Gas 8 – char 15,16			
\$6B	40108	Gas 9 – char 1,2	R	16 bits ASCII	8
~					
\$72	40115	Gas 9 – char 15,16			
\$73	40116	Gas 10 – char 1,2	R	16 bits ASCII	8

~					
\$7A	40123	Gas 10 – char 15,16			
\$7B	40124	Sensor data	R	8 + 8 bit int.	1
\$7C	40125	Set unit to zero	R/W (\$A5)	8 bits int.	1
\$7D	40126	Reset unit to factory default	R/W (\$A5)	8 bits int.	1

Special – Modbus Set Up

PDU Address	Register	Description	Read/Write	Type	No. Registers
\$1003	44100	ID (1-247)	R/W	16 bit int.	1
\$1004	44101	Baud rate 1 = 4800, 2 = 9600 3 = 19K2, 4 = 38K4 5 = 57K6	R/W	16 bit int.	1
\$1005	44102	Parity 1=none, 2=odd, 3=even	R/W	16 bit int.	1
\$1006	44103	TX delay (milliseconds)	R/W	16 bit int.	1
\$1007	44104	Reset unit: Read value from this register and write it back. This will reset the unit	R/W	16 bit int.	1

Registers Explained

The registers are divided into four groups. The first group (40001 – 40012) represents the dynamic data. This group changes the most. The second group (40013 – 40031) contains the settings from the instrument and MaxTrak 180 Modbus specific settings. The third group contains static data about the instruments. The last group (44100 – 44104) contains special functions to change the Modbus settings while the unit is in the network.

Register Descriptions

40001: Actual Flow

The actual flow as measured by the instrument

40003: Set Point

When using a controller the set point is shown. Writing to this register will set the set point. When a set point is entered which is beyond the full scale of the instrument then the set point will be changed automatically to the full scale value.

40005 – 40008: Totalizer

Totalizer value BCD encoded. The first two registers are the value left of the decimal point. The last two registers represent the value behind the decimal point.

Example:

40005 = 0x0010

40006 = 0x1204

40007 = 0x1654

40008 = 0x4500

Total = 12040010.45001654

40009: Valve Power

Value representing the power injected into the valve (when using a controller). The value will range between 0 and 3200 (4095 when purging the valve).

40010 - 40011: Analog Inputs 1 & 2

Values from the analog inputs are presented as raw values ranging between 0 and 1023. The analog input settings determine the range.

40012: Alarm Status

Status indication for the alarms: See chapter about the alarm system for more information.

40013: Factory Full Scale

Factory full scale value of the instrument.

40015: User Full Scale

The user full scale value allows you to re-range the instrument. Any value between 50% and 100% of the factory full scale is allowed. The new value will also redefine the analog outputs of the instrument (when used). The 20mA/5 Vdc will represent the new full scale value.

40017: Gas Span

The gas span value allows you to adjust the calibration linearly of each available gas, value can range between 0.5 and 2. This function is not supported on the first generation of SmartTrak instruments serial numbers 124,999 and lower.

40019 - 40022: Trigger Point Alarm

Trigger values for alarm. See chapter about the alarm system for more information.

40023: Alarm Control Register

See chapter about the alarm system for more information.

40024: Trigger Source Alarm

Trigger source for alarm 1: See chapter about the alarm system for more information.

40025: Analog Input Settings

This register controls the way the analog inputs behave. The table below shows the possible settings.

Bit	Function
	Analog input 1
0	Input multiplier, 0 = 1x, 1 = 0.5x
1	Input mode, 0 = voltage, 1 = current
	Analog input 2
2	Input multiplier, 0 = 1x, 1 = 0.5x
3	Input mode, 0 = voltage, 1 = current
	Common settings
7	Reference, 0 = 2.56V, 1 = 5V

40026: Gas Index

Value shows which gas is selected on the instrument. Value can range between 1 and 10.

40027: Valve Position Index

Mode at which the valve of the controller will operate. The table shows the available values:

Value	Mode
1	Automatic
2	Closed
3	Purge

40028: Flow Unit Index

The value indicates the selected flow unit on the instrument. The table shows the available values:

Value	Unit
1	Sc/s
2	Sc/m
3	Sc/h
4	Ncc/s
5	Ncc/m
6	Ncc/h
7	SCF/s
8	SCF/m
9	SCF/h
10	NM3/s
11	NM3/m
12	NM3/h
13	SM3/s
14	SM3/m
15	SM3/h
16	Sl/s
17	Sl/m
18	Sl/h
19	NI/s
20	NI/m
21	NI/h
22	g/s
23	g/m
24	g/h
25	Kg/s
26	Kg/m
27	Kg/h
28	Lb/s
29	Lb/m
30	Lb/h

40029: Password

Current set password in the instrument. This password doesn't affect the MaxTrak 180 Modbus.

40030: Input Set Point Index

Value indicates the source for the set point. The table shows the available values:

Value	Source
1	RS-232
2	0 – 5 volts
3	0 – 10 volts
4	1 – 5 volts
5	4 – 20 mA
6	0 – 20 mA (180 or higher)

**Caution!**

Select RS-232 as source when the set point needs to be controlled through the network.

40031: Analog Output Index

Analog output index is the value which indicates the current selected analog output of the instrument. The table shows the available values:

Value	Output option
1	0 – 5 Vdc / 4 – 20 mA
2	0 – 10 Vdc / 4 – 20 mA
3	1 – 5 Vdc / 4 – 20 mA
4	0 – 5 Vdc / 0 – 20 mA (serial number 125,000 or higher)
5	0 – 10 Vdc / 0 – 20 mA (serial number 125,000 or higher)
6	1 – 5 Vdc / 0 – 20 mA (serial number 125,000 or higher)

40032: Firmware Revision

Firmware revision number of the instrument

40034: Device Type

There are two characters indication the type of instrument attached to the MaxTrak 180 Modbus. The first character (high byte) indicates the version number of the MaxTrak (1, 2 or other). The second character (low byte) indicates if a meter 'M' or controller 'C' is attached.

Example:

'1C' = MaxTrak 1 - controller, '2M' = MaxTrak2 - Meter

40032 - 40038: Serial Number

Serial number of the instrument expressed as an eight character string.

40039 - 40043: Tag

Tag (or label) string which is set in the MaxTrak 180 Modbus: The tag can only be set in boot loader mode and can be used f.i. to identify the instrument or its location.

40044 – 40051: Gas Name 1

40052 – 40059: Gas Name 2

40060 – 40067: Gas Name 3

40068 – 40075: Gas Name 4

40076 – 40083: Gas Name 5

40084 – 40091: Gas Name 6

40092 – 40099: Gas Name 7

40100 – 40107: Gas Name 8

40108 – 40115: Gas Name 9

40116 – 40123: Gas Name 10

Gas table present in the instrument.

40124: Sensor Data

Sensor data from the instrument (not available on a SmartTrak 1 serial numbers 124,999 and lower: The high byte shows the bridge voltage and the low byte shows the bridge current.

40125: Set Unit To Zero

Writing the value 0xA5 to this register will set the zero the instrument (not available on the SmartTrak 1 serial numbers 124,999 and lower). See the 180 manual for more information serial numbers 125,000 and higher.

40126: Reset Unit To Factory Default

Writing the value 0xA5 to this register will reset all custom settings to factory defaults (not available on the SmartTrak 1 serial numbers 124,999 and lower). The zero value and gas span values are cleared.

Special Modbus Set Up Registers

The Modbus settings for the MaxTrak 180 Modbus can be altered while it is connected to the network. Through special registers it is possible to change the settings. The settings can be changed but will not become active until a special write is performed.

44100: Id

The ID code as stored in memory is shown. The ID code set through the ID pins on P1 is not shown. Any value between 1 and 255 can be used.

44101: Baud Rate

Value	Baud rate
1	4800
2	9600
3	19K2
4	38K4
5	57K6

44102: Parity

Value	Parity
1	None
2	Odd
3	Even

44103: TX Delay

The value in this register will tell the MaxTrak 180 Modbus to wait a number of milliseconds before starting to transmit the reply to the master.

Delay time = value x 1ms

44104: Reset Unit

Writing back the value from this register will trigger two events:

1. The values entered for the ID code, baud rate, parity and TX delay will be stored in memory (making them permanent)
2. The MaxTrak 180 Modbus will perform a power-up reset using the new settings

The new settings are now active. The new settings will not be stored unless the correct value is written to this register. When the settings are changed and a manual reset is performed then the old settings will be used.

Chapter 4: Alarm System

The MaxTrak 180 Modbus has an alarm system which can monitor a register and generate an alarm when the value inside the register goes beyond a predefined level. The alarm status is set on the alarm output.

The alarm system can also monitor the power consumed by the valve in controllers. When the valve reaches maximum power it will generate heat. Under normal working conditions it will be cooled by the flow. When no flow is present and the valve runs on maximum power it will become very hot and can be damaged in the long run. The alarm system can shut the valve down when it runs on maximum power.

Alarm Principle

The alarm principle is based on performing a compare on a value. When the value becomes bigger (or smaller) than a predefined value an alarm will be triggered.

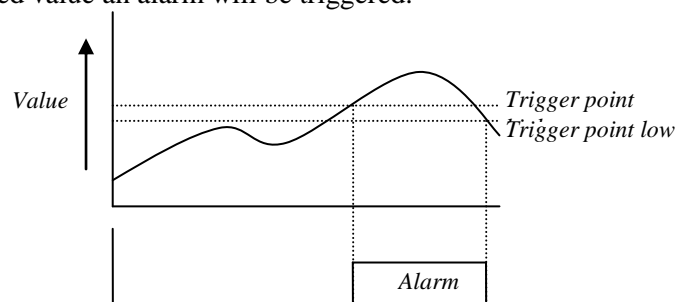

Figure 3 Trigger polarity set to higher

When the value becomes higher than the trigger point (high) the alarm will be set. The alarm output is pulled to ground. When the value drops below the low trigger point then the alarm condition is cleared (alarm output returns to tri-state output).

Alarm Control

There are six registers which control the alarm system. There is a control register in which the behavior of the system is defined. A status register gives an overview of the alarm status. Each alarm channel has its own trigger level register.

Alarm Control Register (40023)

The alarm control register sets the behavior of the alarm.

Overview:

Bit	Function
	Alarm1
0	Enable alarm (0 = off / 1 = on) <i>When not set the alarm will not function</i>
1	Enable output (0 = off / 1 = on) <i>When set digital output1 will be triggered to reflect the alarm state. Setting this bit will disable the output function.</i>
2	Trigger polarity (0 = lower / 1 = higher) <i>Select if the alarm will be triggered when the actual value is higher or lower than the trigger value (trigger source)</i>
3	Alarm lock mode (0 = disabled / 1 = enabled) <i>When cleared the alarm status bit will be toggled according to the alarm condition. When set the alarm status bit (and possible output) will be locked once an alarm has occurred. Clearing the status bit will clear the alarm state.</i>
	Various

8	Valve power alarm (0 = enabled / 1 = disabled) <i>When enabled the set point will be set to zero after 5 minutes when the valve power stays at 3200 the whole time.</i>
9	Sensor failure alarm (0 = enabled / 1 = disabled) <i>If the sensor malfunctions then an alarm is set (180only!)</i>
Alarm1 – Extra Option (overwrites other settings)	
10	Set point to zero (0 = disabled / 1 = enabled) – highest priority
11	Valve mode set to close (returns to present valve mode when alarm cleared) (0 = disabled / 1 = enabled)

When the alarm lock mode is enabled then the alarm output will remain active even when the alarm condition has been cleared. The alarm output can only be cleared by writing a zero to the status bit in the alarm status register.

The trigger polarity bit determines if an alarm is raised when the monitored value is higher or lower than the trigger value. Setting it to one will raise the alarm when the value becomes higher than the trigger value.

Trigger Source (40024)

The alarm channel has a trigger source. The source is a Modbus register whose content is monitored. The following table gives an overview of all the registers which can be used:

Modbus Register	Description
40001	Actual flow
40003	Set point
40005	Totalizer left side of the decimal point
40007	Totalizer right side of the decimal point
40009	Valve power
40010	Analog channel 1
40011	Analog channel 2
40015	User full scale
40017	Gas span
40025	Analog input settings
40026	Gas index
40027	Valve position index
40028	Flow unit control
40029	Password
40030	Input set point index
40031	Analog output index

Trigger Point (level)

Enter the trigger point at which the alarm needs to react. The alarm will become active when the trigger value is exceeded (not when equal or smaller). The entered value will be converted to a data type belonging to the trigger source.

Alarm Status Register

The alarm status register will indicate the actual status of the alarm.

Bit	Status
0	Alarm (0 = no alarm, 1 = alarm)
2	Valve power (0 = no alarm, 1 = alarm)
3	Sensor failure – ST2 only serial number 125,000 and higher. (0 = no alarm, 1 = alarm)

In lock mode the status bit for the alarm can be cleared by setting the bit to zero. The valve power bit is also cleared by writing a zero to it.

The sensor failure bit can't be cleared by making it zero.

Chapter 5: Bootloader

Introduction

This chapter describes how the boot loader is used. The boot loader makes it possible to set up applications and download firmware using a simple terminal program and a serial connection.

Getting started

In order to use the Bootloader, a PC is needed which is equipped with an RS-485 interface or an external converter connected to the RS-232 port.

1. Connect the RS-485 interface of the MaxTrak 180 Modbus to the RS-485 interface of the PC. On the PC start a simple terminal program like HyperTerminal.

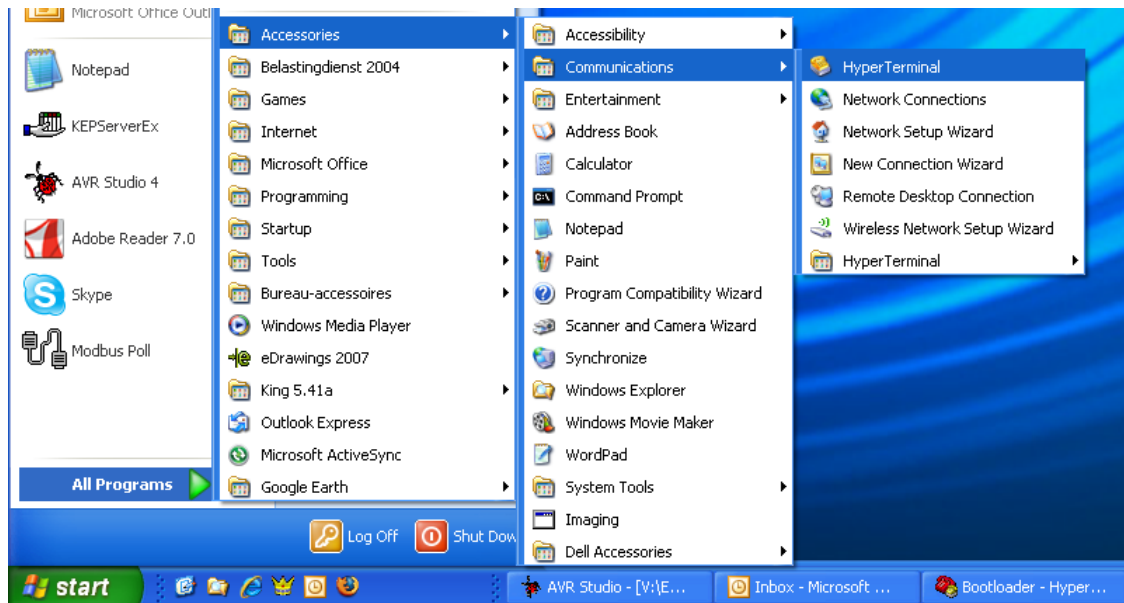

2. Start HyperTerminal from windows and select the com port to which the RS-485 interface is connected. Use the following settings:

Baud rate : 9600
Number of bits : 8
Parity : N
Stop bits : 1

The boot loader will only be active during the first 2 seconds after a power-up or reset. During power-up (or reset) none of both LED's will be lit. To enter the boot loader, follow the next steps:

1. Power up the unit
2. In HyperTerminal press the enter key within 2 seconds of power up (any other key will terminate the boot loader and will start the application)
3. When the boot loader is activated successfully the following menu will be presented on the screen:

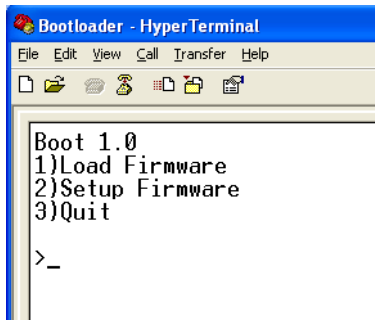

The version of the boot loader is shown and three options. By pressing the “1”, “2” or “3” key an option is selected.

Load Firmware

Press “1” to download firmware to the unit. The following screen will be presented:

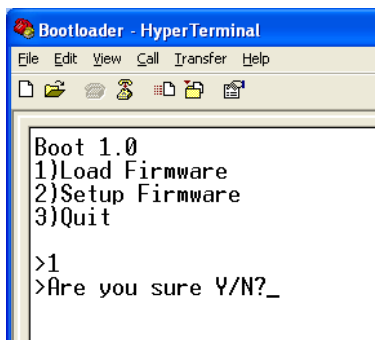

A question is presented asking to continue. Press the “Y” or “y” key to continue. Press “N” or “n” to abort. When continuing the following screen will be presented:

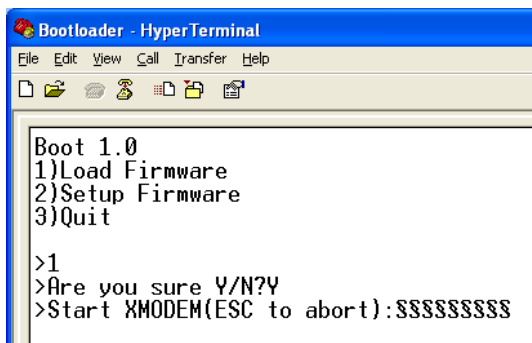

The screen will start to fill up with the “\$” character indicating that the XMODEM transfer can be started. Press the “ESC” key to abort.

From the “Transfer” menu select “Send file.”

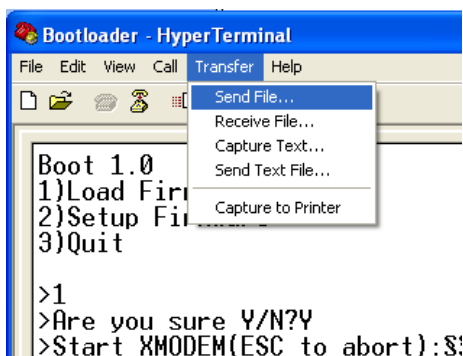

A new screen will be presented asking for the file to be transferred:

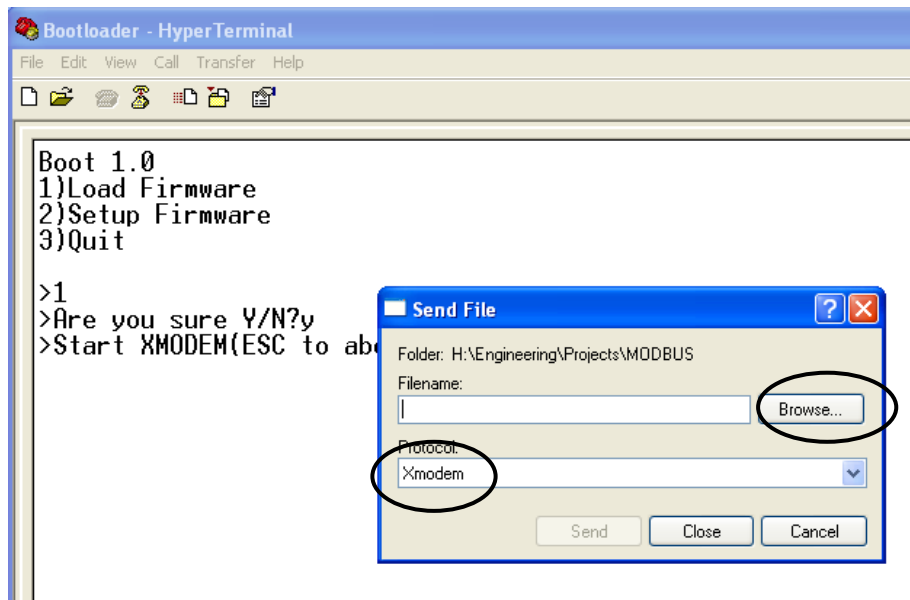

Use the “Browse” button to select the file to download. Only files with the “.hex” extension can be downloaded to the unit. Also make sure that the “Xmodem” protocol is selected. When the file is selected, press the “Send” button. The transfer screen pops up and the file download status can be monitored.

If the download needs to be cancelled then simple press the “Cancel” button and then press the “Esc” key to return to the boot menu.

	<p>Caution! Once the download has started it isn't possible to stop it. Doing so <i>will</i> result in losing the current application.</p>
---	---

The download is now in progress:

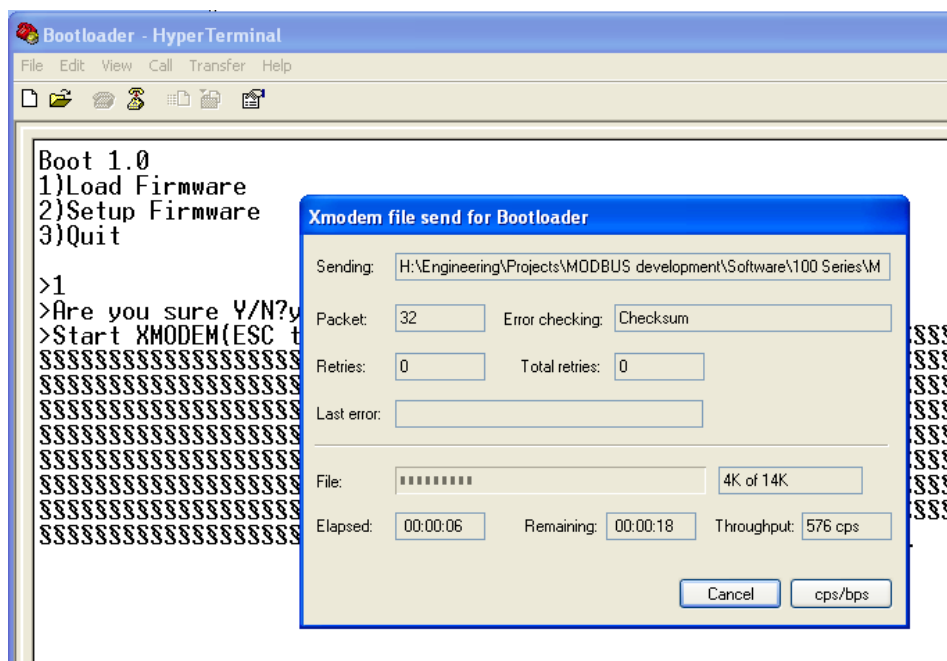

When the download is finished the start-up screen will be shown again presenting three options.

Setup Firmware

This option is used to set up the firmware in the unit. When pressing the “2” key the following screen will be presented:

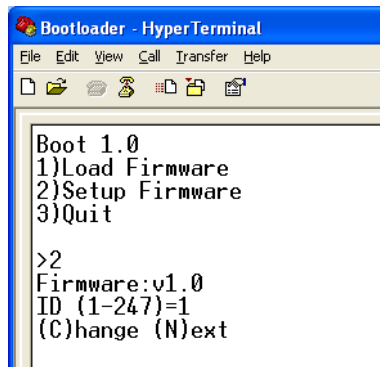

```
Boot 1.0
1)Load Firmware
2)Setup Firmware
3)Quit

>2
Firmware:v1.0
ID (1-247)=1
(C)hange (N)ext
```

The version of the firmware will be shown followed by the first option which can be set. It will show the current selected value as well which values can be entered.

In this above example, the ID code of the unit can be set between 1-247 and the current setting is 1.

Pressing the “C” or “c” key will prompt for a new value. Enter a new value and press the “Enter” key. The new value will be stored and the next option will be presented (if available). Data which can be entered must match the type presented. So in the above example only numbers can be entered. Characters will be ignored. Also the size of the entry will be limited depending on the maximum size allowed.

When all options have been viewed the default boot menu will be presented again. The options presented will depend on the firmware.



Note

While entering a new value the “backspace” key can be used to erase entered values.



Caution!

It is advised to only enter values which are shown between the brackets. Other values may be entered but could result in the unit not functioning correctly.

Quit

This option will quit the boot loader and will start the application.

Trouble Shooting

Problem	Solution
During the firmware transfer the download has halted and nothing is happening anymore (or an error message appears)	Reset the unit and try again. Make sure that only .hex files intended for the unit are selected
When trying the enter data the length is limited. No more data is expected	For each option the data type and length are predefined. When data isn't accepted anymore than the maximum is reached. Also it's not possible to enter characters when numbers are expected (and vice-versa)
The characters on the screen are all messed up	Check the communication settings. They should be 9600,8,N,1
The unit doesn't enter the boot loader although the enter key is pressed within 2 seconds after start-up	Try swapping the "A" & "B" lines of the RS-485 connection and try again