



InnovaSonic® 203

InnovaSonic® Model 203

Economical Ultrasonic Liquid Flow Meter

Instruction Manual

Version IM-203, Rev. L, February 2023



SIERRA®

GLOBAL SUPPORT LOCATIONS: WE ARE HERE TO HELP!

CORPORATE HEADQUARTERS

5 Harris Court, Building L
Monterey, CA 93940

Phone (831) 373-0200 / (800) 866-0200

Fax (831) 373-4402

www.sierrainstruments.com

EUROPE HEADQUARTERS

Bijlmansweid 2
1934RE Egmond aan den Hoef

The Netherlands

Phone +31 72 5071400

Fax +31 72 5071401

ASIA HEADQUARTERS

Second Floor Building 5, Senpu Industrial Park
25 Hangdu Road Hangtoun Town

Pu Dong New District, Shanghai, P.R. China

Postal Code 201316

Phone: + 8621 5879 8521

Fax: +8621 5879 8586

© COPYRIGHT SIERRA INSTRUMENTS 2023

No part of this publication may be copied or distributed, transmitted, transcribed, stored in a retrieval system, or translated into any human or computer language, in any form or by any means, electronic, mechanical, manual, or otherwise, or disclosed to third parties without the express written permission of Sierra Instruments. The information contained in this manual is subject to change without notice.

TRADEMARKS

InnovaSonic® is a Registered Trademark of Sierra Instruments, Inc. Other product and company names listed in this manual are trademarks or trade names of their respective manufacturers.

Important Customer Notice

Thank you for choosing the InnovaSonic® Model 203 Economical Transit-Time Ultrasonic Flow Meter with SLSI CMOS and low-voltage wide-pulse sending technology. This manual contains important information about your meter. Before installing and operating this flow meter, please read this manual carefully and follow its instructions.

- ✓ Sierra has verified the conformity between the contents in this manual and the hardware and software described. However, errors may still exist. We regularly review the materials covered in this manual and correct errors with revisions. Any suggestions for improvement will be appreciated.
- ✓ Go to www.sierrainstruments.com/products/downloads.html for a most current electronic version of this manual.
- ✓ We reserve the right to change the content of this manual without prior notification.
- ✓ If you have any questions or problems regarding this manual, please contact Sierra's Customer Service

Customer Service Department:

Toll Free: 800-866-0200 Phone: +831-373-0200 Fax: 831-373-4402

Email: service@sierrainstruments.com

WARNINGS IN THIS MANUAL

Warning, attention, and note statements are used throughout this book to draw your attention to important information.



WARNING

"Warning" statement appears with information that is important to protect people and equipment from damage. Pay very close attention to all warnings that apply to your application. **Failure to comply with these instructions may damage the meter and personal injury.**



ATTENTION

"Attention" statements in this manual indicate that failure to comply with stated instructions **may result in damage to the meter or faulty operation of the flow meter.**





NOTE

"Note" indicates that ignoring the relevant requirements or precautions **may result in flow meter damage or malfunction.**

Product Components

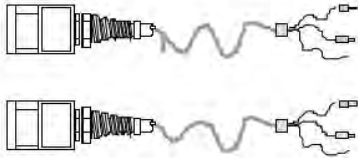
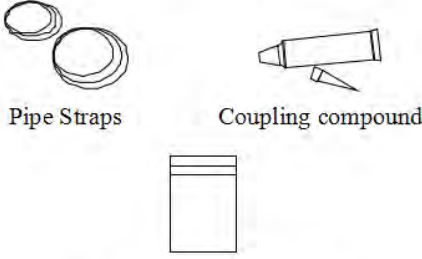
Inspect the flow meter prior to installation. Check the parts against the packing list. Make sure that there is no transport damage.

Transmitter	Transducers
 <p>The transmitter is a rectangular device with the Sierra logo and 'InnovaSonic 203' printed on it. It features a numeric keypad with 12 buttons labeled: 'rate', 'total', 'start', 'Menu', 'back', 'flow', 'temp', '^/+', 'flow', 'alarm', 'Enter', 'flow', 'alarm', 'diag', and 'V/-'. Below the keypad are four circular ports.</p>	 <p>Two identical transducers are shown, each consisting of a cylindrical probe with a multi-pin connector at the end.</p>
Accessories	Documents
 <p>Three items are shown: two pipe straps, a tube of coupling compound with a nozzle, and a small rectangular installation accessory.</p> <p>Pipe Straps Coupling compound</p> <p>Installation accessory</p>	 <p>Three documents are listed:</p> <ol style="list-style-type: none"> 1. Instruction Manual 2. Packing List 3. Position drawing

Content

1. Transmitter Installation and Wiring	8
1.1. INSPECTION PRIOR TO TRANSMITTER INSTALLATION.....	8
1.2. WIRE CONNECTIONS.....	9
1.2.1. <i>Power Supply Option</i>	9
1.2.2. <i>Transmitter Wiring</i>	9
1.2.3. <i>Longer Cables (> 9 m)</i>	9
1.2.4. <i>Junction Box Connections</i>	10
1.2.5. <i>Junction Box Requirements</i>	10
1.3. POWERING ON.....	11
1.4. KEYPAD FUNCTIONS	11
1.5. KEYPAD OPERATION.....	11
1.6. FLOW METER MENU DESCRIPTIONS	12
2. Pipe Parameter Entry Shortcuts.....	14
2.1. DUAL FUNCTION KEYS MENU DESCRIPTION	14
2.2. MENU SYSTEM EXAMPLES.....	15
3. Measurement Site Selection.....	17
4. Transducer Installation	18
4.1. INSTALLING THE TRANSDUCERS.....	18
4.1.1. <i>Transducer Spacing</i>	18
4.1.2. <i>Transducer Mounting Methods</i>	18
4.1.3. <i>V Method</i>	18
4.1.4. <i>Z Method</i>	19
4.1.5. <i>N Method (not commonly used)</i>	19
4.2. TRANSDUCER MOUNTING INSPECTION.....	19
4.2.1. <i>Signal Strength</i>	20
4.2.2. <i>Signal Quality (Q value)</i>	20
4.2.3. <i>Total Time and Delta Time</i>	20
4.2.4. <i>Transit Time Ratio</i>	20
5. Operating Instructions	22
5.1. SYSTEM NORMAL IDENTIFICATION	22
5.2. ZERO SET CALIBRATION.....	22
5.3. SCALE FACTOR	22
5.4. SYSTEM LOCK (UNLOCK)	23
5.5. 4~20MA CURRENT LOOP VERIFICATION.....	23
5.6. FREQUENCY OUTPUT.....	23

5.7	TOTALIZER PULSE OUTPUT.....	24
5.8	ALARM PROGRAMMING.....	24
5.9	RECOVER THE FACTORY DEFAULT.....	24
5.10	4-20mA ANALOG OUTPUT CALIBRATION.....	25
5.11	ESN.....	25
6.	Menus Display Explanations.....	26
6.1.	MENUS DISPLAY CODES.....	26
6.2.	DISPLAY EXPLANATION.....	27
7.	Error Diagnosis.....	41
7.1	TABLE 1. SELF-DIAGNOSIS AND ERROR SOLUTIONS (UPON POWER ON).....	41
7.2	TABLE 2. ERROR CODES AND SOLUTIONS (DURING OPERATION).....	42
7.2	FREQUENTLY ASKED QUESTIONS AND ANSWERS.....	43
8.	Product Overview.....	44
8.1	THEORY OF OPERATION.....	44
8.2	SPECIFICATIONS.....	45
9.	Appendix1-Serial Interface Network Use and Communications Protocol.....	48
9.1	OVERVIEW.....	48
9.2	SERIAL PORT PIN DEFINITIONS.....	48
9.3	CONNECTION TO RS-232/RS-485 HOST DEVICE.....	49
9.4	Modbus-RTU Communication Protocol.....	50
10.	Appendix2-Warranty Policy.....	50
10.1	Limited Warranty Policy - Register Online.....	50

Update Information:

1. Transmitter Installation and Wiring

1.1. Inspection prior to Transmitter Installation

You will find a “Position Drawing” in the packing. Please use it as a template for flow meter installation. Drill 4 installation holes at the positions shown on the drawing (use 5.5mm drill).

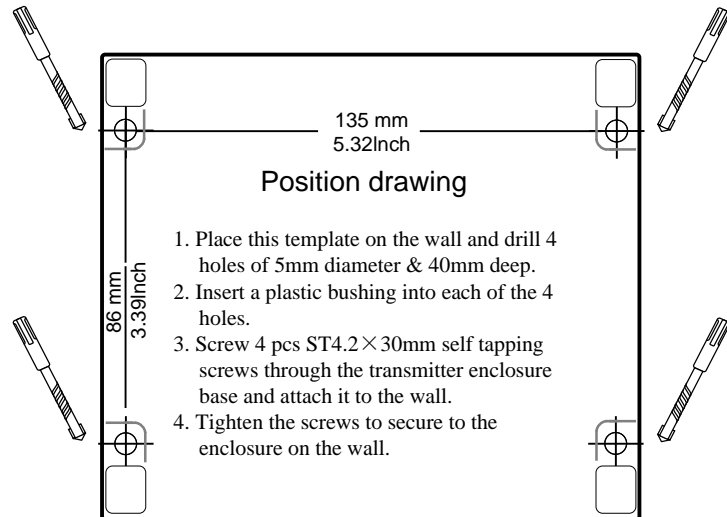

Take out the enclosed screws and plastic bushings. Insert the plastic bushings into the installation holes. Put the flow meter in position and screw in the screws.

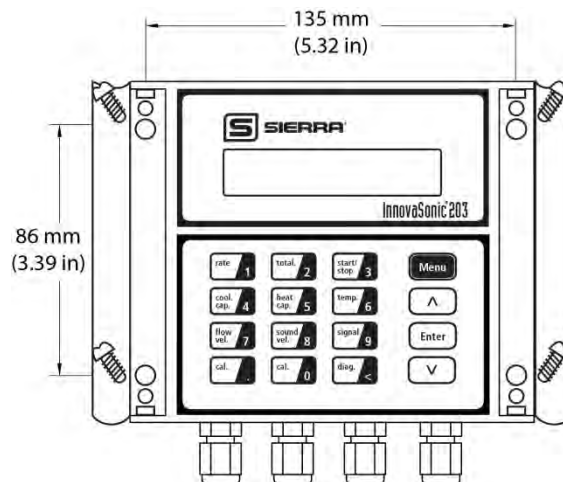

ATTENTION

When installing please ensure the front cover is secure and will not fall open.

1.2. Wire Connections

1.2.1. Power Supply Option

Factory standard power supply is 10 to 36 VDC at 1A max.

1.2.2. Transmitter Wiring

Once the electronics enclosure has been installed, the flow meter wiring can be connected.

Viewing the TB, you will find the transmitter interface labels from left to right:

Power supply, Relay output, OCT Output, Upstream transducer, Downstream transducer, 4-20mA, RS-232 (optional) or RS-485 interface.

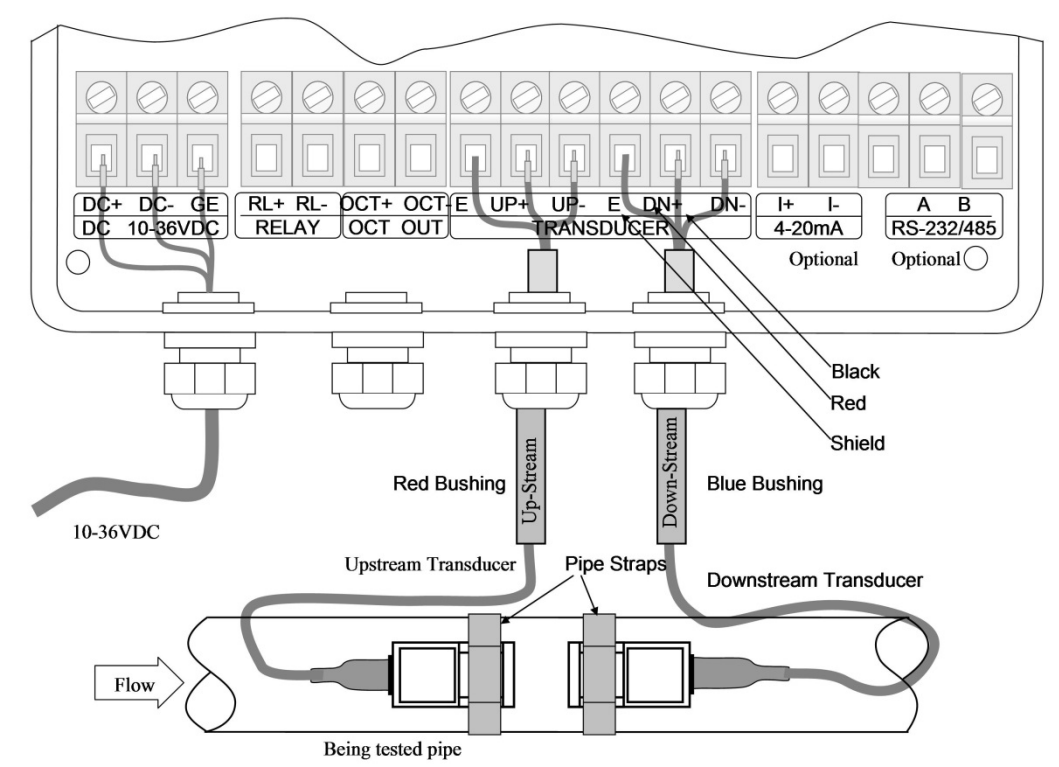

Figure 1. Transmitter Wiring

1.2.3. Longer Cables (> 9 m)

Standard cable length is 9 meters (30 ft); it can be lengthened to be 300 meters (984 ft) via a junction box.

1.2.4. Junction Box Connections

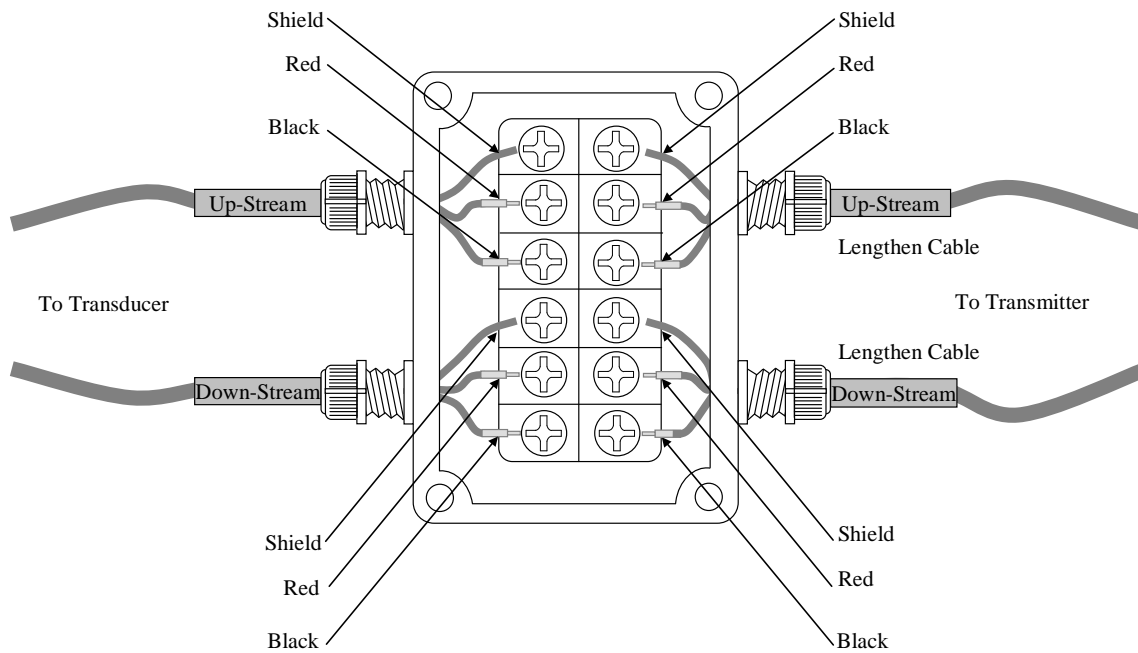

Figure 2. Junction Box Connections

1.2.5. Junction Box Requirements

The flow meter can use a sealed waterproof 6x2 junction box to extend the transducer wires

Cable Specifications

Name: Shielded Twisted Pair

Standard: JB8734.5-1998

Diameter: $\Phi 5$ mm

Twist Line Space: 50 mm

Multi Core Line: $0.4 \text{ mm}^2/\text{radix}$

Gauge: AWG 20#

Core Line Color: Red and Black

Shield Floor: 128 Intwine



WARNING

Wire with power off. The flow meter must have reliable grounding before installation.



1.3. Powering on

As soon as the flow meter is switched on, the self-diagnosis program will start to run. If any error is detected, an error code will display on the screen (Refer to Error Diagnostic section of this manual). After the self-diagnosis, the system will run automatically using the last input parameters.

When the meter is switched on, gain adjustment can be monitored in Menu M01. After S1, S2, S3, S4 are displayed on the upper left corner of the screen, the system will begin measuring. Normal condition is indicated by code “*R” on the upper left corner of the screen.

If it is the first use or install on a new site, the customer will need to input the new installation site parameters. The system will default to the last menu settings and automatically display them at next power on.

1.4. Keypad Functions

The InnovaSonic 203 keypad offers 16 tactile keys with 12 dual-function keys for easy operation of the menu system and setup. The quick-key functions are enabled by pressing directly on the related key. You do not need to press the  key to enable quick-key functions. For example, pressing  will show flow rate and pressing  will show totalized flow. See the Chapter 2 for detailed explanations of all they keys.

Follow these guidelines when using the InnovaSonic 203 menu system:















- Keys  -  are the menu codes to input information required for the flow measurement exercise.
- Push  to backspace or delete characters to the left.
- Use  and  to return to the previous menu or to open the next menu. These keys act as "+" and "-" functions when entering numbers.
- The Menu key  is used to select a menu using two digit numbers for each menu. To enter a selected menu, press  key first then press your selected digit numbers. Hit enter to save the selected menu. For example, to input a pipe outside diameter, press    keys, where "11" is the window ID to display the parameter for pipe outside diameter.









Figure 3. 16 Tactile Keys With 12 Dual-Function Keys



1.5. Keypad Operation

The flow meter uses menus to enter/display data. The operator can input parameters, modify settings or display measurement results by “visiting” a specific menu. These menus are arranged by 2-digit serial numbers (including “+” sign) from 00~99, then to +0, +1, etc. Each menu ID code has a defined meaning. For example, menu M11 indicates the pipe outside diameter, while menu M25 indicates the mounting spacing between the transducers

To visit a specific menu, press the  key, then input the 2-digit menu ID code. For example, to input or check the pipe outside diameter, press the    keys.











Another method to visit a particular menu is to press   and  keys to scroll the screen. For example, if the current menu ID code is M02, press  key to enter menu M01, press the  button again to enter menu M00; then, press the  key to go back to menu M01, and press the  key again to enter menu M02.

Menus are separated into three types: (1) Data Type, such as M11, M12; (2) Option Type, such as M14; (3) Display Type, such as M01, M00.

You can check/enter numerical data by visiting the Data Type menus. If you want to modify the data, input the digits and press  or press  first, input the digits then press  again to confirm.

















Example 1: To enter a pipe outside diameter of 219.234, the procedure is as follows:

Press    keys to enter menu M11 (the numerical value displayed currently is the previous value). Now press  key. The symbol “>” and the flashing cursor are displayed at the left end of the second line on the screen. Then input pipe OD and press enter to confirm.      

Pipe Outer Diameter

>_

You can select various configurations by using pull down menus in the Option Type menus. If you want to modify these, press  first, the symbol “>” and the flashing cursor are displayed at the left of the screen. Use  and  to scroll pull down menu options, then press  to confirm the selected option, or enter the corresponding value directly and press  to confirm.

For example, if the pipe material is not “Stainless Steel”, press    to enter menu M14, press  to modify the options. Scroll to “1. Stainless Steel” option by pressing  and , then press  to confirm the selection; It is also possible to press  key to change the selection and wait until “1.Stainless Steel” is displayed on the second line of the screen, then press  to confirm.

Pipe Material [14
>1. Stainless Steel



ATTENTION

Generally, press the  key first if you want to change data. If there is no response “”, it means that system is locked by a password. To “Unlock” it, select “Unlock” in Menu M47 and enter the original password.

1.6. Flow Meter Menu Descriptions

Menus are assigned as follows:

- 00~09 Flow Totalizer Display: display flow rate, positive total, negative total, net total, velocity, date & time, present operation and flow results today.
- 10~29 Initial Parameter Setup: to enter pipe outside diameter, pipe wall thickness, fluid type, transducer type, transducer mounting method and spacing, etc.
- 30~38 Flow Units Options: to select the flow unit such as cubic meters, liters or other units, turn totalizers on/off and reset totalizers, etc.
- 40~49 Setup options: set Scaling factor, system lock (Menu M47), etc.
- 50~89 Input and output setup: date and time, ESN, communication baud rate setting, etc.
- 90~94 Diagnostics: Signal strength and signal quality (Menu M90), TOM/TOS*100 (Menu M91), flow sound velocity (Menu M92), total time and delta time (Menu M93), Reynolds number and factor (Menu M94), etc.

+0~+5 Appendix: power on/off time, total working hours, on/off times and a single-accuracy function calculator.



Attention

other menus not listed are for hardware adjustment (factory use).

2. Pipe Parameter Entry Shortcuts

2.1. Dual Function Keys Menu Description

Rate/1 Key 

Press this key to display Maximum Flow Rate. The function is the same with Window M02. Press the key again to see Min. then Avg. Flow rates.

```
Flow Max .
      360.0000 m3/h
```

Total/2 Key 

Press this key to display Net Totalizer. The function is the same with Window M00.

```
Day Totalizer
      700.1000 m3
```

Start/Stop/3 Key 

Press this key to start and stop Manual Totalizer in turn.

```
      60 sec
ON    10.123 m3
```

Cool Cap./4 Key 

Reserved for future use.

Heat Cap./5 Key 

Reserved for future use..

Temp./6 Key 

Reserved for future use.

Flow Vel./7 Key 

Press this key to display Velocity. The function is the same with Window M01.

```
Flow 0.1129 m3/h * R
Vel  1.0415 m/s
```

Sound Vel./8 Key 

Press this key to enter Fluid Sound Velocity in Window M92.

```
Fluid Sound Velocity
      0.0000m/s
```

Signal/9 Key 

Press this key to display Signal Strength and Signal Quality. The function is the same with Window M90.

```
Strength + Quality [90
UP:00.0 DN:00.0 Q=00
```

Cal./ Key 

Press this key to start Manual Totalizer, then press the key again to end Manual Totalizer.

```
Manual Calibrate
Press Ent When Ready
```

Zero/0 Key 

Press this key to input code 1234 to set zero.

```
Set Zer o
Please Enter PW
```



Diag./< Key

Press this key to display System Error Code. The function is the same with Window M08.

* R- - - - -
System Normal

2.2. Menu System Examples

Example, pipe has diameter of DN200, measuring water, Pipe Material is carbon steel, No Liner

Step 1. Pipe outside diameter:

Press keys to enter menu M11, enter the pipe outside diameter of , then press the key to confirm.

Pipe Outer Diameter
200 mm

Step 2. Pipe wall thickness

Press key to enter menu M12, enter the pipe wall thickness of , then press the key to confirm. Note: If this value is a decimal less than 1.00, it must be preceded by a zero. Example: .375 must be entered as 0.375.

Pipe Wall Thickness
6 mm

Step 3. Pipe material

Press keys to enter menu M14, press the key to bring up the scroll down options, press the or key to scroll to the correct pipe material (in this case carbon steel), then press the key to confirm.

Pipe Material [14
0. Carbon Steel

Step 4. Transducers type

Although other types are available, select STANDARD transducers.

Transducer Type [23
0. Standard

Step 5. Transducer mounting methods

Press key to enter menu M24, press the key, press the or key to select transducer-mounting method, and press the key to confirm. IN MOST CASES, start with the V method and switch to the Z method if signal strength/quality is insufficient.



Transducer Mounting
0. V

Step 6. Transducer spacing

Press key to enter menu M25, THE METER WILL CALCULATE THE CORRECT SPACING FOR THE MOUNTING METHOD selected in menu 24 above. Install as directed.

Transducer Spacing
159.86 mm

Step 7. Display measurement result

Press    keys to enter menu M01 to display measurement results. *R indicates normal operation.

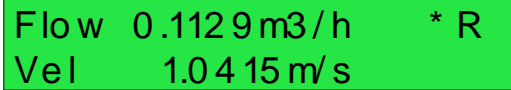

Flow 0.1129 m³/h * R
Vel 1.0415 m/s

3. Measurement Site Selection

When selecting a measurement site, it is important to select an area where the fluid flow profile is fully developed. Use the following guidelines to select a proper installation site:

Choose a section of pipe that is always full of liquid, such as a vertical pipe with flow in the upward direction or a full horizontal pipe.

Ensure enough straight pipe length at least equal to the figure shown below for the upstream and downstream transducers installation.

Name	Straight length of upstream piping	Straight length of downstream piping
90° bend		
Tee		
Diffuser		
Reduce		
Valve		
Pump		

Figure 4. Measurement Site Selection

Ensure that the pipe surface temperature at the measuring point is within the transducer temperature limits.

Consider the inside condition of the pipe carefully. If possible, select a section of pipe where the inside is free of excessive corrosion or scaling.

4. Transducer Installation

4.1 Installing the Transducers

Before installing the transducers, clean the pipe surface where the transducers are to be mounted. Remove any rust, scale or loose paint and make a smooth surface. Choose a section of sound conducting pipe for installing the transducers. Apply a wide band of sonic coupling compound down the center of the face of each transducer as well as on the pipe surface, ensure there are no air bubbles between the transducers and the pipe wall, and then attach the transducers to the pipe with the straps provided and tighten them securely.



NOTE

The two transducers should be mounted at the pipe's centerline on horizontal pipes. Make sure that the transducer mounting direction is parallel with the flow.

During the installation, there should be no air bubbles or particles between the transducer and the pipe wall. On horizontal pipes, the transducers should be mounted in the 3 o'clock and 9 o'clock positions of the pipe section in order to avoid any air bubbles inside the top portion of the pipe. (Refer to Transducer Mounting). If the transducers cannot be mounted horizontally symmetrically due to limitation of the local installation conditions, it may be necessary to mount the transducers at a location where there is a guaranteed full pipe condition (the pipe is always full of liquid).

4.1.1 Transducer Spacing

After entering the required parameters, the spacing between the ENDS of the two transducers is considered as the standard transducer spacing (Refer to Top View on transducer mounting methods). Check the data displayed in Menu M25 and space the transducers accordingly.

4.1.2 Transducer Mounting Methods

Three transducer mounting methods are available. They are respectively: V method, Z method and N method. The V method is primarily used on small diameter pipes (DN100~300mm, 4" ~12"). The Z method is used in applications where the V method cannot work due to poor signal or no signal detected. In addition, the Z method generally works better on larger diameter pipes (over DN300mm, 12") or cast iron pipes.

The N method is an uncommonly used method. It is used on smaller diameter pipes (below DN50mm, 2").

4.1.3 V Method

The V method is considered as the standard method. It usually gives a more accurate reading and is used on pipe diameters ranging from 50.8mm to 400mm (2~16") approximately. Also, it is convenient to use, but still requires proper installation of the transducers, contact on the pipe at the pipe's centerline and equal spacing on either side of the centerline.

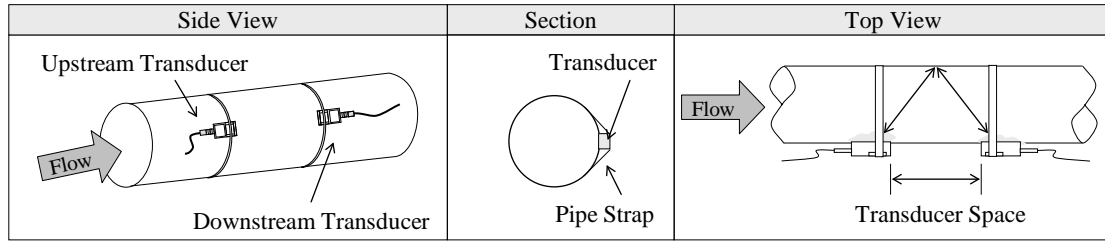

Figure 5. V Method Transducer Mounting Method

4.1.4 Z Method

The signal transmitted in a Z method installation has less attenuation than a signal transmitted with the V method. Use for big pipes, if there are some suspended solid in the fluid, or the scaling and liner are too thick. This is because the Z method utilizes a directly transmitted (rather than reflected) signal which transverses the liquid only once.

The Z method is able to measure on pipe diameters ranging from 100mm to 800mm (4" ~32") approximately. Therefore, we recommend the Z method for pipe diameters over 300mm (12").

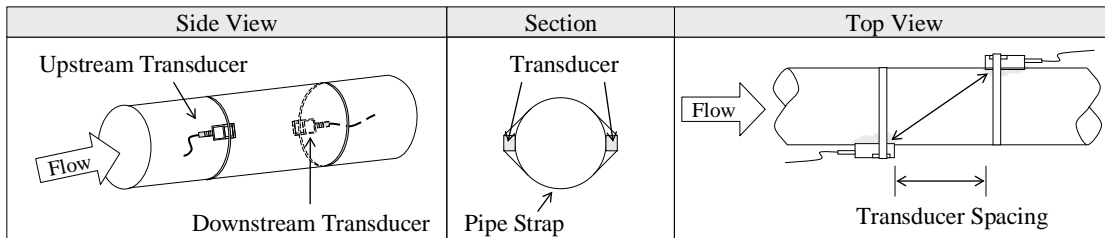

Figure 6. Z Method Transducer Mounting Method

4.1.5 N Method (not commonly used)

With the N method, the sound waves traverse the fluid three times and bounce twice off the pipe walls. It is suitable for small pipe diameter measurement.

The measurement accuracy can be improved by extending the transit distance with the N method (uncommonly used).

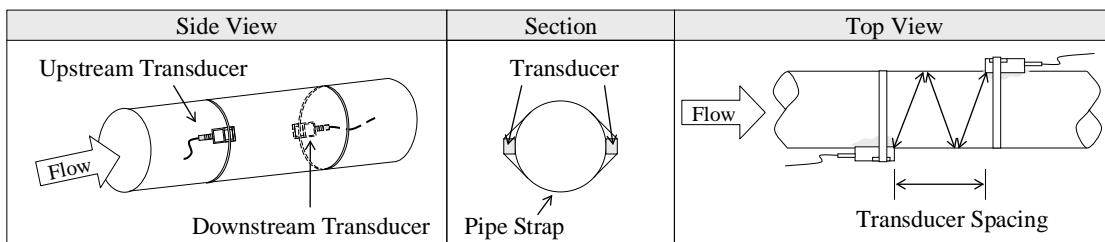

Figure 7. N Method Transducer Mounting Method

4.2 Transducer Mounting Inspection

Check to see if the transducer is installed properly and if there is an accurate and strong enough ultrasonic signal to ensure proper operation and high reliability of the transducer. This can be confirmed by checking the detected signal strength, total transit time, delta time and transit time ratio.

The “mounting” condition directly influences the flow value accuracy and system reliability. In most instances, you need only apply a wide band of sonic coupling compound lengthwise on the face of the transducer and stick it

to the outside pipe wall to get good measurement results. However, the following inspections still need to be carried out in order to ensure the high reliability of the measurement and long-term operation of the instrument.

4.2.1 Signal Strength

Signal strength (displayed in menu M90) indicates a detected strength of the signal both from upstream and downstream directions. The relevant signal strength is indicated by numbers from 00.0~99.9. 00.0 represents no signal detected while 99.9 represents maximum signal strength.

Normally, the stronger the signal strength detected, the more stable the measurement value obtained.

Fine tune the sensor placement by adjusting the transducers to obtain the maximum signal strength.

System normal (*R) requires signal strength over 60.0, which is detected from both upstream and downstream directions. If the signal strength detected is too low, the transducer installation position and the transducer mounting spacing should be re-adjusted and the pipe should be re-inspected. If necessary, change the mounting method to be Z method.

4.2.2 Signal Quality (Q value)

Q value is short for Signal Quality (displayed in menu M90). It indicates the level of the signal detected. Q value is indicated by numbers from 00~99. 00 represents the minimum signal detected while 99 represent the maximum.

The transducer position should be adjusted until the signal quality detected is as strong as possible.

4.2.3 Total Time and Delta Time

“Total Time and Delta Time”, which displays in menu M93, indicates the condition of the installation. The measurement calculations in the flow meter are based upon these two parameters. Therefore, when “Delta Time” fluctuates widely, the flow and velocities fluctuate accordingly, and the signal quality detected is too poor. It may be the resulted of poor pipe installation conditions, inadequate transducer installation or incorrect parameter input.

Generally, “Delta Time” fluctuation should be less than $\pm 20\%$. Only when the pipe diameter is too small or velocity is too low can the fluctuation be wider.

4.2.4 Transit Time Ratio

Transit Time Ratio indicates the transducer mounting spacing is accurate. The normal transit time ratio should be 100 ± 3 . Check it in menu M91.

ATTENTION

If the transit time ratio is over 100 ± 3 , it is necessary to check:



- (1) If the parameters (pipe outside diameter, wall thickness, pipe material, liner, etc.) have been entered correctly.
 - (2) If the transducer mounting spacing is accordance with the display in menu M25.
 - (3) If the transducer is mounted at the pipe's centerline on the same diameter.
 - (4) If the scale is too thick or the pipe mounting is distorted in shape, etc.
-

WARNINGS





- (1) Pipe parameters entered must be accurate; otherwise the flow meter will not work properly.
 - (2) During the installation, apply enough coupling compounds in order to stick the transducers onto the pipe wall. While checking the signal strength and Q value, move the transducers slowly around the mounting site until the strongest signal and maximum Q value can be obtained. Note that the larger the pipe diameter, the more the transducers may have to be
-

moved

- (3) Check to be sure the mounting spacing is accordance with the display in menu M25 and the transducer is mounted at the pipe's centerline on the same diameter.
 - (4) Pay special attention to those pipes with seams, since such pipe is always irregular.
 - (5) If the signal strength is always displayed as 0.00, that means there is no signal detected. Thus, it is necessary to check that the parameters (including all the pipe parameters) have been entered accurately. Check to be sure the transducer mounting method has been selected properly, the pipe is not worn-out, and the liner is not too thick. Make sure there is indeed fluid in the pipe or the transducer is not too close to a valve or elbow, and there are not too many air bubbles in the fluid, etc. With the exception of these reasons, if there is still no signal detected, the measurement site has to be changed.
-

5 Operating Instructions

5.1 System Normal Identification

Press the    keys. If the letter “*R” is displayed, it indicates system normal.

- If the letter “E” is displayed, it indicates that the current loop output is over ranged by 100%. This refers to the settings in menu M57. Enter a larger value in Menu M57, and the letter “E” will disappear. It can be ignored if no current loop output is used.
- If the letter “Q” is displayed, it indicates that the frequency output is over ranged by 120%. This refers to the settings in Menu M69. Increase the input value in Menu M69, and the letter “Q” will disappear. It can be ignored if no frequency output is used.
- If the letter “H” is displayed, it indicates that the ultrasonic signal detected is poor. For more information, please refer to “Error Diagnosis”.
- If the letter “G” is displayed, it indicates that system is adjusting the signal gain prior to the measurement. Also, it means system normal. Only when the adjustment takes too long without stopping, can the system be identified as abnormal. You will normally see this at start up.

Letter “I” indicates no signal is being detected. Check that the transducer wiring connections are correct, the transducers are installed firmly, etc.

Letter “J” indicates a hardware defect exists. Normally, such a defect is temporary; it can be eliminated by system reboot (power off and restart).

Letter “F” indicates hardware defect.

For further information, please refer to “Error Diagnosis”.

5.2 Zero Set Calibration

With no movement of liquid in the pipe, the meter should read zero.

For an ultrasonic flow meter, the measurement difference from zero point cannot be ignored at low flow. It is necessary to perform a static zero set calibration to improve low flow measurement accuracy.

Press Menu M42 to set the Zero, press  first, and then wait the readings displayed at the lower right corner reducing to be “0”. If this is carried out with flow, the flow will be displayed as “0”, M43 can help to restore factory settings. You should note that, even with no flow, there could still be movement of fluid in the pipe due to temperature or pressure differentials.

5.3 Scale Factor







Scale factor refers to the ratio between “actual value” and “reading value”. For example, when the measured value is 2.00, and it is indicated as 1.98 on the instrument, the scale factor reading is 2/1.98. This means that the best scale factor constant is 1.







However, it is difficult to keep the scale factor as “1” on the instrument especially in batch productions. The difference is called “consistency”.

During operation, there still exists possible difference in pipe parameters, etc. The “scale factor” may be necessary when used on different pipes. Thus, scale factor calibration is specially designed for calibrating the differences that result from application on different pipes. The scale factor entered must be one that results from actual calibration. The scale factor can be input in Menu M45.

5.4 System Lock (Unlock)

System lock is readable but un-editable to prevent operation error due to unauthorized tampering.

Press the     keys, if displays “Unlock” on the screen, then press the  key, enter a 1~4 numerically long password, and then press the  key to confirm.







Unlock it by using the selected password only. Press    , if displays “lock” on the screen press the  key and enter the correct password, then press  to confirm. Keep the password in mind or recorded in a safe place, otherwise the instrument cannot be used.

5.5 4~20mA Current Loop Verification

With a current loop output exceeding an accuracy of 0.1%, the flow meter is programmable and configurable with multiple output modes such as flow rate or fluid velocity. Select in Menu M55. For details, please refer to “Menus Display Explanations”.

In Menu M56, enter a 4mA flow rate or fluid velocity value. Enter the 20mA flow rate or fluid velocity value in Menu M57. For example, if the flow range in a specific pipe is 0~1000m³/h, enter 0 in Menu M56 and 1000 in Menu M57.

Calibrating and testing the current loop is performed in Menu M58. Complete the steps as follows:

Press    , move  or  to display “0mA”, “4mA”, “8mA”, “12mA”, “16mA”, “20mA” readings, connect an ammeter to test the current loop output and calculate the difference. Calibrate it if the difference is within tolerance. If the difference is without tolerance, refer to the “Analog Output Calibration” to calibrate the current loop.

Check the present current loop output in Menu M59 as it changes along with change in flow.

5.6 Frequency Output

The flow meter is provided with a frequency output transmitter function. The high or low frequency output displayed indicates the high or low flow rate reading. The user can reset the frequency output as well as flow rate per his requirements.

For example: if a pipe flow range is 0~3000m³/h and the relative frequency output required is 123~1000Hz, the configuration is as follows:

In Menu M68 (low limit frequency output flow value), input 0;

In Menu M69 (high limit frequency output flow value), input 3000;

In Menu M67 (low limit frequency range) input 123 ;(high limit frequency range) input 1000.

There is no output circuit specially assigned to frequency output. It only can be transmitted through OCT, i.e. select the fifth item in Menu M78 (item “5. FO”).

Typical OCT (Open Collector Transistor) Output wiring diagram as below:

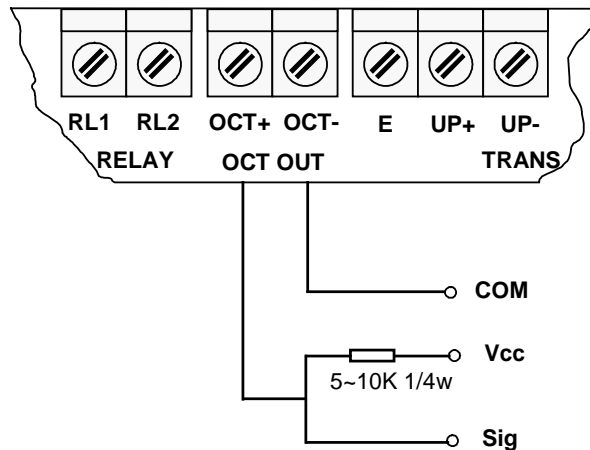

Figure 8. OCT Output Wiring Diagram

5.7 Totalizer Pulse Output

Each time the flow meter reaches a unit flow, it may generate a totalizer pulse output to a remote counter.

The totalizer pulse output can be transmitted through OCT or Relay output. So it is necessary to configure OCT or Relay accordingly. (Please refer to Menu M78, M79) For example, if it is necessary to transmit the positive totalize pulse through a Relay, and each pulse represents a flow of 0.1m³; the configuration is as follows:

1. In Menu M33, select totalizer the flow unit “Cubic Meter (m³)” ;
2. In Menu M34, select the scale factor “x0.1”;
3. In Menu M79, select “3. Net totalizer pulse output”.

5.8 Alarm Programming

The on/off output alarm is generated through OCT or Relay output. The on/off output signal is activated under the following conditions:

1. The transmitter can't receive the ultrasonic signals.
2. Alarm #1 is out of limit.
3. Alarm #2 is out of limit.

5.9 Recover the Factory Default

Press to Menu M37, press keys to recover the factory default.







5.10 4~20mA Analog Output Calibration





NOTE

Each flow meter has been calibrated before leaving factory. It is unnecessary to carry out this step except when the current value (detected while calibrating the current loop) displayed in Menu M58 is not identical with the actual output current value.

The hardware detect menu must be activated prior to calibration the Analog Output. The procedure is as follows:

Press      enter password “115800”, then press  to activate the detect menu. With no effect to next power on, this menu will close automatically as soon as the power is turned off.

Press  to calibrate the current loop 4mA output. Use a milliamp meter to measure the current loop output current. At the same time, press  or  to adjust the displayed numbers. Watch the ammeter until it reads 4.00. Stop at this point, the 4mA has been calibrated.

Then, press  to calibrate the current loop 20mA output. The method is the same as 4mA calibration.

The results are automatically saved in EEPROM and won't lose when power off.

5.11 ESN

We provide the flow meter with a unique electronic serial number to identify each flow meter for the convenience of the manufacturer and customers. The ESN is able to be viewed in Menu M61.



ATTENTION

Other Operation refers to “6.2 Menus Display Explanations”.

6. Menus Display Explanations

6.1. Menus Display Codes

Flow Totalizer Display	
00	Flow Rate/Net Totalizer
01	Flow Rate/Velocity
02	Flow Rate/POS Totalizer
03	Flow Rate/NEG Totalizer
04	Date Time/Flow Rate
08	System Error Codes
09	Net Flow Today
Initial Parameter Setup	
11	Pipe Outer Diameter
12	Pipe Wall Thickness
14	Pipe Material
23	Transducer Type
24	Transducer Mounting Method
25	Transducer Spacing
26	Parameters Setups
28	Holding with Poor Sig
29	Empty Pipe Setup
Flow Units Options	
30	Measurement Units
31	Flow Rate Units
32	Totalizer Units
33	Totalizer Multiplier
34	Net Totalizer
35	Pos Totalizer
36	NEG Totalizer
37	Totalizer Reset
38	Manual Totalizer
Setup Options	
40	Damping
41	Low Flow Cutoff Value
42	Set Static Zero
43	Reset Zero
44	Manual Zero Point
45	Scale Factor
46	Network Identifying Address Code
47	System Lock
Input and Output Setup	
55	CL Mode Select
56	CL 4mA Output Value
57	CL 20mA Output Value

58	CL Check
59	CL Current Output
60	Date and Time
61	ESN
62	Serial Port Parameter
63	Reserved
64	Reserved
67	FO Frequency Range
68	Low FO Flow Rate
69	High FO Flow Rate
70	LCD Backlit Option
72	Working Timer
73	Alarm #1 Low Value
74	Alarm #1 High Value
75	Alarm #2 Low Value
76	Alarm #2 High Value
77	Beeper Setup
78	OCT Output Setup
79	Relay Output Setup
82	Date Totalizer
83	Automatic Correction
Calorimetry	
84	Reserved
85	Reserved
86	Reserved
87	Reserved
88	Reserved
89	Reserved
Diagnosis	
90	Signal Strength and Quality
91	TOM/TOS*100
92	Fluid Sound Velocity
93	Total Time and Delta
94	Reynolds Number and Factor
Appendix	
+0	Power ON/OFF Time
+1	Total Working Hours
+2	Last Power Off Time
+3	Last Flow Rate
+4	ON/OFF Times
-0	Hardware Adjusting Entry

NOTE: The other menu features are retained by manufacturers and the menus in gray background are optional functions.

6.2. Display Explanation

While reading this section, please compare it with the instrument in order to improve your understanding.



Flow Rate / Net Totalizer

Display flow rate and net totalizer.

If the net totalizer has been turned off (refer to M34), the net totalizer value displayed is the total prior to its turn off.

Flow 0.1154 m³/h * R
NET 0 x 1m³



Flow Rate / Velocity

Display flow rate and velocity.

Flow 0.1129 m³/h * R
Vel 1.0415 m/s



Flow Rate / Positive Totalizer

Display flow rate and positive totalizer.

Select the positive totalizer units in Menu M31.

If the positive totalizer has been turned off, the positive totalizer value displayed is the total prior to its turn off.

Flow 0.1129 m³/h * R
POS 0 x 1m³



Flow Rate / Negative Totalizer

Display flow rate and negative totalizer.

Select the negative totalizer value in Menu M31.

If the negative totalizer has been turned off (refer to M36), the value displayed is the total prior to turn off.

Flow 0.1120 m³/h * R
NEG 0 x 1m³



Date Time / Flow Rate

Display the current date time and flow rate.

The time setting method can be found in Menu M60.

03-04-03 15:49:40 * R
Flow 0.1116 m³/h



System Error Codes

Display the working condition and the system error codes. More than one error code can occur at the same time.

The explanations of error codes and detailed resolution methods can be found in “Error Diagnoses”.

* R - - - - -
System Normal



Net Flow Today

Display net total flow today.

Net Flow Today M09
0.458748 m³



Pipe Outer Diameter

Enter the pipe outside diameter or enter the pipe circumference in Menu M10. The pipe outside diameter must range from 51mm to 6000mm.

Note: Enter either pipe outside diameter or pipe circumference.

Pipe Outer Diameter
50 mm



Pipe Wall Thickness

Enter the pipe wall thickness.

Pipe Wall Thickness
4 mm



Pipe Material

Enter pipe material. The following options are available by $\wedge/+$ and $\vee/-$ buttons or numerical keys:

0. Carbon Steel	1. Stainless Steel
2. Cast Iron	3. Ductile Iron
4. Copper	5. PVC
6. Aluminum	7. Asbestos
8. Fiber Glass-Epoxy	

Pipe Material [14
0. Carbon Steel



Transducer Type

- 0. Standard
- 1. Ty-45B

“Standard” is clamp-on type transducer,
“Ty-45B ” is WS inserted type
transducer(optional).

Transducer Type [23
0. Standard



Transducer Mounting

Four mounting methods are available:

- 0. V
- 1. Z use
- 2. N (for small pipe)

Transducer Mounting
0. V



Transducer Spacing

The operator must mount the transducer according to the transducer spacing displayed (be sure that the transducer spacing must be measured precisely during installation). The system will display the data automatically after the pipe parameter had been entered.

Transducer Spacing
148.666 mm



Initial Parameter Setups and Save

Load and save the parameters. 18 different sets of setup conditions/groups are available to load and save by three methods (i.e.-you can load and save 18 different applications):

0. Entry to Save
1. Entry to Load
2. To Browse

Select “Entry to Save”, press . An ID code and the original parameters are displayed in the menu. Press or to move the ID code, then press the key again to save the current parameter in the current ID room.

When selecting “Entry to Load”, press , and the system will read and calculate the parameters automatically and display the transducer mounting spacing in Menu M25.

Parameter Setups
Entry to SAVE



Holding with Poor Sig

Select “Yes” to hold last good flow signal displayed if the Flow meter experiences a poor signal condition. This function will allow continued data calculation without interruption.

Holding with Poor Sig
NO



Empty Pipe Setup

This parameter is used to overcome the possible problems that usually show up when the pipe being measured is empty. Since signals can be transmitted through the pipe wall, the flow meter may still read a flow while measuring an empty pipe. To prevent this from happening, you can specify a value. When the signal quality falls below this value, the measurement stops automatically. If the flow meter is already able to stop measuring when the pipe is empty, a value in the range of 30 to 40 should also be entered in this menu to ensure no measurement when the pipe is empty.

* It should be understood that the instrument is NOT designed to function correctly on an empty pipe.

Empty Pipe Setup [29
0



Measurement Units Options

Select the measurement unit as follows:

0. Metric
1. English

Factory default is metric.

Measurement Units In
0. Metric



Flow Rate Units Options

The following flow rate units are available:

0. Cubic Meters (m³)
1. Liters (l)
2. USA Gallons (GAL)
3. Imperial Gallons (Imp gal)
4. Million Gallons (mg)
5. Cubic Feet (cf)
6. USA Barrels (US bbl)
7. Imperial Barrels (Imp bbl)
8. Oil Barrels (Oil bbl)

The following time units are available:

- | | |
|------|-------|
| /Day | /Hour |
| /Min | /Sec |

Factory default is Cubic Meters/hour

Flow Rate Units [31
m³/h



Totalizer Units Options

Select totalizer units. The available unit options are as same as those found in Menu M31. The user can select units as their requirement. Factory default is Cubic Meters.

Totalizer Units [32
Cubic Meter (m³)



Totalizer Multiplier Options

The totalizer multiplier acts as the function to increase the totalizer indicating range. Meanwhile, the totalizer multiplier can be applied to the positive totalizer, negative totalizer and net totalizer at the same time.

The following options are available:

0. X0.001(1E-3)
1. X0.01
2. X0.1
3. X1
4. X10
5. X100
6. X1000
7. X10000(1E+4)

Factory default factor is x1.

Totalizer Multiplier
0. x0.001(1E-3)



ON/OFF Net Totalizer

On/off Net Totalizer. “ON” indicates the totalizer is turned on, while “OFF” indicates it is turned off. When it is turned off, the net totalizer displays in Menu M00 will not change. Factory default is “ON”.

Net Totalizer [34]
ON



ON/OFF POS Totalizer

On/off POS Totalizer. “ON” indicates the Flow meter starts to totalize the value. When it is turned off, the positive totalizer displays in Menu M02 will not change. Factory default is “ON”.

POS Totalizer [35]
ON



ON/OFF NGE Totalizer

On /off NGE Totalizer. “On” indicates the totalizer is turned on. When it is turned off, the negative totalizer displays in Menu M03 will not change.

Factory default is “ON”.

NEG Totalizer [36]
ON



Totalizer Reset

Totalizer reset; all parameters are reset. Press ; press or arrow to select “YES” or “NO”. After “YES” is selected, the following options are available:

- None: No reset
- All: Reset all totalizers
- NET Totalizer Reset
- POS Totalizer Reset
- NEG Totalizer Reset

Totalizer Reset? [37]
Selection

Press to reset all parameter back to simplified defaults.

**Attention**

This operation will delete the entire user's data and reset as the factory default. Please consider carefully before taking this operation.



Manual Totalizer

The manual totalizer is a separate totalizer. Press to start, and press to stop it. It is used for flow measurement and calculation.

**Manual Totalizer [38
Press ENT When Ready**



Damping Factor

The damping factor ranges from 0~999 seconds. 0 indicates no damping; 999 indicates the maximum damping.

The damping function will stabilize the flow display. Its principle is the same as that in a single-section RC filter. The damping factor value corresponds to the circuit time constant.

Usually a damping factor of 3 to 10 is recommended in applications.

**Damping [40
10 sec**



Low Flow Cutoff Value

Low Flow Cutoff is used to make the system display as “0” value at lower and smaller flows to avoid any invalid totalizing. For example, if the cutoff value is set as 0.03, system will take all the measured flow values below ± 0.03 as “0”. Usually 0.03 is recommended in most applications.

**Low Flow Cutoff Val.
0.01 m/s**



Set Static State Zero

When fluid is in the static state, the displayed value is called “Zero Point”. When “Zero Point” is not at zero in the Flow meter, the difference is going to be added into the actual flow values and measurement differences will occur in the Flow meter.

Set zero must be carried out after the transducers are installed and the flow inside the pipe is in the absolute static state (no liquid movement in the pipe). Thus, the “Zero Point” resulting from different pipe mounting locations and parameters can be eliminated. The measuring accuracy at low flow is enhanced by doing this and flow offset is eliminated. Press , wait for the processing instructions at the right corner bottom to reach 0.

Performing Set zero with existing flow may cause the

**Set Zero [42
Press ENT to go**

flow to be displayed as “0”. If so, it can be recovered via Menu M43.



Reset Zero

Select “YES”; reset “Zero Point” which was set by the user.

```
Reset Zero [43
NO
```



Manual Zero Point

This method is not commonly used. It is only suitable for experienced operators to set zero under conditions when it is not preferable to use other methods. Enter the value manually to add to the measured value to obtain the actual value. For example:

Actual measured value = 250 m3/H

Value Deviation = -10 m3/H

Flow meter Display = 240 m3/H

```
Manual Zero Point [44
0 m3/h
```

Normally, set the value as “0”.



Scale Factor

The scale factor is used to modify the measurement results. The user can enter a numerical value other than “1” according to the actual calibration results.

```
Scale Factor [45
1
```



Network IDN

Input system identifying code, these numbers can be selected from 0~65535 except that 13 (0DH ENTER), 10 (0AH Newline), 42 (2AH *) and 38 (26H&) are reserved. System IDN is used to identify the flow meter to a network

```
Network IDN [46
88
```



System Lock

Lock the instrument.

Once the system is locked, any modification to the system is prohibited, but the parameter is readable. “Unlock” using your designated password. The password is composed of 1 to 4 numbers.

```
System Lock [47
* * * * Unlocked * * * *
```



Current Loop Mode Select

```
CL Mode Select [55
0. 4 - 20 mA
```

Select the current loop mode. The following options are available:

- 0. 4-20mA Output Mode set up the 4-20mA output to be flow rate mode
- 1. 4-20mA vs. Vel. set up the 4-20mA output to be flow velocity mode
- 2. 4-20mA vs. Energy set up the 4-20mA output to be energy mode

Other different current output characteristics are displayed in below figures. The user can select one of them according to his actual requirements.

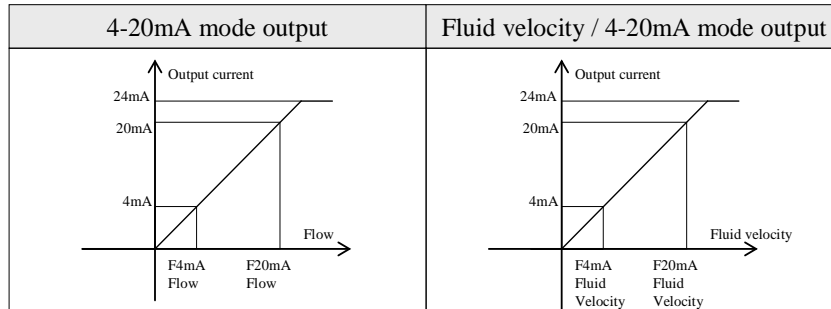

In two graphs shown above, flow F_{4mA} indicates the value that the user entered in Menu M57; and flow F_{20mA} indicates the value that the user entered in Menu M58. In the 4-20mA modes, F_{4mA} and F_{20mA} can be selected as a positive or negative flow value as long as the two values are not the same.

In 4-20mA flow rate mode, the output current is indicated as velocity. In 4-20mA energy mode, the output is indicated as energy.



CL 4mA Output Value

Set the CL output value according to the flow value at 4mA. The flow unit's options are the same as those in Menu M31. Once "4-20mA vs.Vel." is selected in Menu M56, the unit should be set as m/s.



20mA Output Value

Set the CL output value according to the flow value at 20mA. the flow unit is the same as that found in Menu M31. Once "4-20mA vs.Vel." is selected in Menu M57, the unit should be set as m/s.

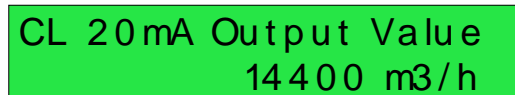

CL Check Verification

Check if the current loop has been calibrated before leaving the factory. Press to start, press to display 0mA, 4mA, 8mA, 12mA, 16mA, 20mA, and at the same time, check with an ammeter to measure the current loop output current and calculate the differences to see if it is under the permitted tolerance. If not, refer to the "Analog Output Calibration" to calibrate.





CL Current Output

Display CL current output. The display of 10.0000mA indicates that CL current output value is 10.0000mA.

If the difference between displaying value and CL output value is too large, the current loop then needs to be re-calibrated accordingly.

CL Current Output [59
15.661 mA



Date and Time Settings

Date and time modifications are made in this menu. The format for setting time setting is 24 hours. Press **Enter**, wait until “>” appears, the modification can be made.

YY- MM- DD HH:MM:SS
03- 04- 04 10:05:04



ESN

Display electronic serial number (ESN) of the instrument. This ESN is the only one assigned to each flow meter ready to leave the factory. The factory uses it for files setup and the user uses it for management.

Ultrasonic Flowmeter
S/N=05071188



Serial Port Settings

This menu is used for serial port setting. Serial port is used to communicate with other instruments.

The serial port parameters setting of the instrument that applies the serial port connection must be consistency. The first selected data indicates baud rate, 9600, 19200, 38400, 56000, 57600, 115200 are available.

The second option indicates parity bit, None (No verification).

Data length fixed to 8;

The factory default serial port parameter is “9600, None”
Stop bit length for a fixed length.

RS- 232 Setup [62
9600, None



AI1 Analog Input Value Range

This menu is for entering Analog Input 4mA and 20mA for temperature or pressure value.

AI 1 Value Range [63
10 - 100



AI2 Analog Input Value Range

This menu is for entering Analog Input 4mA and 20mA for temperature or pressure value.

AI 2 Value Range [64
10 - 100



Set FO Frequency Range

Set up high FO frequency range. It must be higher than the low FO frequency. Ranges from 1-9999Hz. Factory default is 1~1001 Hz.

Note: The frequency output is transmitted through OCT Serial Port; therefore the OCT must be set to the frequency output mode.

FO Frequency Range
1 - 5000



Low FO Flow Rate

Set up low FO flow rate, i.e. the corresponding flow value when output signal frequency is at the lowest FO frequency. For example, when the low FO frequency is 1000Hz, low FO flow rate is 100m3/h then when the frequency output is 1000Hz, the low flow at this moment measured by the Flow meter is 100m3/h.

Low FO Flow Rate [68
0 m3/h



High FO Flow Rate

Enter the high FO flow rate, i.e. the corresponding flow value when frequency output signal is at highest FO frequency. For example, when the low FO frequency is 3000Hz, low FO flow rate is 1000m3/h then when the frequency output is 3000Hz, the low flow at this moment measured by the Flow meter is 1000 m3/h

High FO Flow Rate [69
26550 m3/h



LCD Backlit Option

Select LCD backlit controls.

0. Always OFF,
1. Always ON,
2. Lighting for nn sec

Keeping the backlight off can save about 30mA of power.

LCD Backlit Option
0. Always ON



Working Timer

Display the totalized working hours of the Flow meter since last reset. It is displayed by HH:MM:SS. If it is necessary to reset it, press , and select "YES".

Working Timer [72
000000 11:16:38



Alarm #1 Low Value

Enter the low alarm value. Relevant alarm is turned on in Menus M78 and M79; any of the measured flow,

which is lower than the low value, will activate the alarm in the OCT hardware or Relay output signal.

Alarm #1 Low Value
0 m3/h



Alarm #1 High Value

Enter the high alarm value. Relevant alarm is turned on in Menus M78 and M79; any of the measured flow, which is higher than the high value, will activate the alarm in the OCT hardware or Relay output signal.

Alarm #1 High Value
14400 m3/h



Alarm #2 Low Value

Enter the low alarm value. Relevant alarm is turned on in Menus M78 and M79; any of the measured flow, which is lower than the low value, will activate the alarm in the OCT hardware or Relay output signal.

Alarm #2 Low Value
0 m3/h



Alarm #2 High Value

Enter the high alarm value. Relevant alarm is turned on in Menus M78 and M79; any of the measured flow, which is higher than the high value, will activate the alarm in the OCT hardware or Relay output signal.

Alarm #2 High Value
14400 m3/h



Beeper Setup

Set up the beeper on-off state.

- 0. ON Beeper ON
- 1. OFF Beeper OFF

BEEPER Setup [77
0. ON



OCT Output Setup

Set up the output trigger event sources of the OCT hardware output components.

The following signal options are available:

1. Not Ready(NO*R)	2. Alarm #1
3. Alarm #2	4. NET Int Pulse
5. Energy Pulse	6. FO

OCT Output Setup [78
0. Not Ready (NO* R)



Relay Output Setup

Set up the output trigger event sources of the OCT hardware output components. RELAY is single-tool for controlling the external device.

The following signal options are available:

0. Not Ready(NO*R)	1. Alarm #1
2. Alarm #2	3. NET Int Pulse

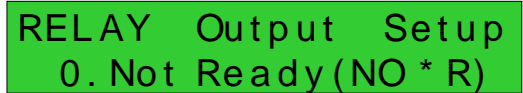

Date Totalizer

In this menu, it is possible to review the historical flow data totalizer for any day of the last 64 days, any month of the last 64 months and any year of the last 5 years. Press , use the or to review totalizer in days, months and years; “0” for day, “1” for month, and “2” for year. Use the or to review the totalizer in some day, some month, some year.

For example, to display the flow total for July 18, 2000, the display “-----” at the upper right corner of the screen indicates that it was working properly the whole day. On the contrary, if “G” is displayed, it indicates that the instrument gain was adjusted at least once. Probably it was offline once on that day. If “H” is displayed, it indicates that poor signal was detected at least once. Also, it indicates that the operation was interrupted or problems occurred in the installation.

For info please refer to “Error Code and Resolutions”.

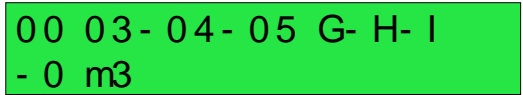
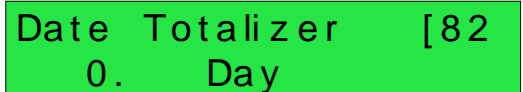

meter was offline. Select “ON” to use this function

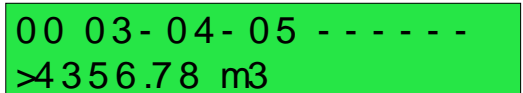

Automatic Flow Correction

With the function of automatic flow correction, the flow lost in an offline session can be estimated and automatically adjusted. The estimate is based on the average value, which is obtained from flow rate before going offline and flow measured after going online the next time, multiplied times the time period that the and “OFF” to cancel this function Normally, signal quality Q value should be better than 50.





Signal Strength and Signal Quality

Display the measured signal strength and signal quality Q value upstream and downstream.

Signal strength is indicated from 00.0 ~ 99.9. A reading of 00.0 indicates no signal detected, while 99.9 indicates maximum signal strength. Normally the signal strength should be ≥ 60.0 . Signal quality Q is indicated by 00 ~ 99. Therefore, 00 indicates the poorest signal while 99 indicates the best signal.

During the installation, pay attention to the signal strength and signal quality, the higher, the better. The strong signal strength and high quality value can ensure the long-term stability and the high accuracy of the measurement results.

Strength+Quality [90
UP:00.0 DN:00.0 Q=00



TOM/TOS*100

Display the ratio between the actual measured transmit time and the calculated transmit time according to customer's requirement. Normally the ratio should be $100 \pm 3\%$. If the difference is too large, the user should check whether the parameters are entered correctly, especially the sound velocity of the fluid and the installation of the transducers. This data is of no use before the system is ready.

TOM/TOS* 100 [91
0.0000%



Fluid Sound Velocity

Display the measured fluid sound velocity. Normally this value should be approximately equal to the entered value in Menu M21. If the difference is too large, it probably results from an incorrect value entered in Menu M21 or improper installation of the transducers.

Fluid Sound Velocity
1443.4 m/s



Total Time and Delta Time

Display the measured ultrasonic average time (unit: μS) and delta time of the upstream and downstream (unit: nS) time. The velocity calculation in the Flow meter is based on the two readings. The delta time is the best indication that the instrument is running steadily. Normally the fluctuation in the ratio of the delta time should be lower than 20%. If it is not, it is necessary to check if the transducers are installed properly or if the parameters have been entered correctly.

Totl Time, Delta Time
8.9149 μS , - 171.09 nS



Reynolds Number and Factor

Display the Reynolds number that is calculated by the Flow meter and the factor that is set currently by the Flow meter. Normally this scaling factor is the average of the line and surface velocity factor inside the pipe.

Reynolds Number [94
0.0000 1.0000

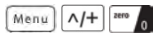

Power ON/OFF Time

To view the power on/off time and flow rate for the last 64 update times to obtain the offline time period and the corresponding flow rate. Enter the menu, press and to display the last update before the last 64 times of on/off time and flow rate values. “ON” on right hand indicates that time power is on; “00” on the upper left corner indicates “00-07-18 12:40:12” the date time; flow rate is displayed in the lower right corner.

ON/OFF Time [+0
Press ENT When Ready

00- 07 18 12:40:12
* ON 123.65 m3/h

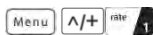

Total Working Hours

With this function, it is possible to view the total working hours since the flow meter left the factory. The figure on the right indicates that the total working hours since the flow meter left the factory is 1107 hours 1 minute 41 seconds.

Total Wbrk Hours [+1
00001107:01:41

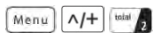

Last Power Off Time

Display the last power off time.

Last Power Off Time
03- 04- 04 11:33:02

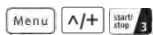

Last Flow Rate

Display the last flow rate.

Last Flow Rate [+3
100.43 m3/h

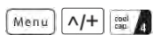

Total ON/OFF Times

Display total on/off times since the flow meter left the factory.

ON/OFF Times [+4
40

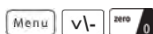

Analog Output Verification

Please refer to the 5.5 “4~20mA Analog Output Verification (optional)”

Hardware Adjusting
Entry

7. Error Diagnosis

The ultrasonic flow meter has advanced self-diagnostics functions and displays any errors in the upper right corner of the LCD via definite codes in a date/time order. Hardware error diagnostics are usually performed upon each power on. Some errors can be detected during normal operation. Undetectable errors caused by incorrect settings and unsuitable measurement conditions can be displayed accordingly. This function helps to detect the errors and determine causes quickly; thus, problems can be solved in a timely manner according to the solutions listed in the following tables.

Errors displayed in the flow meter are divided into two categories:

Table 1 is for errors displayed during self-diagnostics upon power on. “* F” may be displayed on the upper left corner of the screen after entering the measuring mode. When this occurs, it is necessary to power on for self-diagnostics once again to detect and solve possible errors using the table below. If a problem still exists, please contact the factory or the factory’s local representative for assistance.

Table 2 applies when errors caused by incorrect settings and signals are detected and are announced by error codes displayed in Menu M08.

7.1 Table 1. Self-diagnosis and Error Solutions (upon power on)

LCD Display	Cause	Solution
Rom Parity Error	System ROM illegal or error	Contact the factory
Stored Data Error	System stored data block error	Power on again or contact the factory
SCPU Fatal Error	SCPU circuit fatal error	Power on again or contact the factory
Timer Slow Error Timer Fast Error	System clock error	Contact the factory
CPU or IRQ Error	CPU or IRQ problem	Power on again
System RAM Error	System RAM questionable	Power on again or contact the factory
Time or Bat Error	System date time chip error	Power on again or contact the factory
No Display, Erratic or Abnormal Operation	Bad wiring connection	Check wiring connections
Stroke Key - No Response	Keypad locked or bad plug connection	Enter the unlock password if the keypad is locked

7.2 Table 2. Error Codes and Solutions (during operation)

Code	M08 Display	Cause	Solution
*R	System Normal	System normal	No errors
*J	SCPU Fatal Error	Hardware defect	Contact the factory
*I	Signal Not Detected	Signal not detected.	Attach transducer to the pipe and tighten it securely. Apply a plenty of coupling compound on transducer and pipe wall.
		Spacing is not correct between the transducers or not enough coupling compound applied to face of transducers.	Remove any rust, scale, or loose paint from the pipe surface. Clean it with a file.
		Transducers installed improperly.	Check the initial parameter settings.
		Scale is too thick.	Remove the scale or change the scaled pipe section. Normally, it is possible to change a measurement location. The instrument may run properly at a new site with less scale.
		New pipe liner.	Wait until liners solidified and saturated.
*H	Low Signal Strength	Low signal strength. Cause refers to above-mentioned reasons.	Solution refers to above-mentioned solutions.
*H	Poor Signal Quality	Poor signal quality All reasons are included in the above-mentioned causes.	Solution refers to above-mentioned solutions.
*F	Refer to Table 1.	Error in self-diagnoses during power on.	Power on again; resolve it by the method listed in Table 1. If it is still a problem, contact the factory.
		Permanent hardware error.	Contact the factory.
*G	Adjusting Gain>S1 Adjusting Gain>S2 Adjusting Gain>S3 Adjusting Gain>S4 (Display in Menus M00,M01,M02,M03)	Adjusting gain for normal measurement. Stop in S1 or S2 and only switch between S1 and S2 indicates a poor waveform or low signal strength. All reasons may be included in above-mentioned items.	
*K	Pipe Empty. Set in Menu M29	No fluid in pipe or settings incorrect.	Once fluid is detected in the pipe, set 0 in Menu M29.

7.2 Frequently Asked Questions and Answers

Question: New pipe, high quality material, and all installation requirements met: why still no signal detected?

Answer: Check pipe parameter settings, installation method and wiring connections. Confirm if the coupling compound is applied adequately, the pipe is full of liquid, transducer spacing agrees with the screen readings and the transducers are installed in the right direction.

Question: Old pipe with heavy scale inside, no signal or poor signal detected: how can it be resolved?

Answer: Check if the pipe is full of fluid. Try the Z method for transducer installation (If the pipe is too close to a wall, or it is necessary to install the transducers on a vertical or inclined pipe with flow upwards instead of on a horizontal pipe).

Carefully select a good pipe section and fully clean it, apply a wide band of coupling compound on each transducer face (bottom) and install the transducer properly.

Slowly and slightly move each transducer with respect to each other around the installation point until the maximum signal is detected. Be careful that the new installation location is free of scale inside the pipe and that the pipe is concentric (not distorted) so that the sound waves do not bounce outside of the proposed area.

For pipe with thick scale inside or outside, try to clean the scale off, if it is accessible from the inside. (Note: Sometimes this method might not work and sound wave transmission is not possible because of the layer of scale between the transducers and pipe inside wall).

Question: Why is the flow rate still displayed as zero while there is fluid obviously inside the pipe and a symbol of “R” displayed on the screen?

Answer: Check to see if “Set Zero” was carried out with fluid flowing inside the pipe (Refer to Menu M42). If it is confirmed, recover the factory default in Menu M43.

8. Product Overview

8.1 Theory of Operation

When the ultrasonic signal is transmitted through the flowing liquid, there will be a difference between the upstream and downstream transit time (travel time or time of flight), which is proportional to flow velocity, according to the formula below.

$$V = \frac{MD}{\sin 2\theta} \times \frac{\Delta T}{T_{up} \cdot T_{down}}$$

$$\Delta T = T_{up} - T_{down}$$

Remarks:

- V Medium Velocity
- M Ultrasonic frequency of reflection
- D Pipe Diameter
- θ The angle between the ultrasonic signal and the flow
- T_{up} Transit time in the forward direction
- T_{down} Transit time in the reverse direction

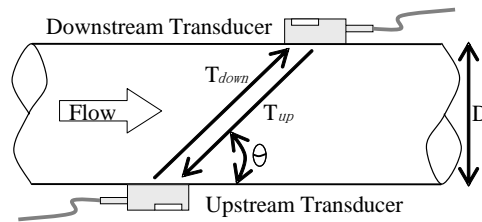

8.2 Specifications

PERFORMANCE SPECIFICATIONS

Accuracy
+/- 1.0% of reading from 1.6 to 40 ft/s (0.49 to 12 m/s)

Repeatability
+/- 0.3% of reading

Pipe Size
2 to 48 inches (50.8 to 1200 mm)

OPERATION SPECIFICATIONS

Flow Range
1.6 to 40 ft/s (0.49 to 12 m/s)

Temperature
Ambient: 14°F to 122°F (-10°C to 50°C)
Operating: 32°F to 140°F (0°C to 60°C)

Power Supply
10 to 36 VDC at 1A (sold separately)

Output
Analog: 4 to 20 mA current loop (max load 750 Ω)
Pulse output: 0 to 9999 Hz, OCT, (min. and max. frequency is adjustable)
Relay output: SPST, max 1 Hz, (0.3 A@ 125VAC or 1A @ 30VDC)
Digital output: Modbus RTU, RS-485

Keypad
16 tactile keys with 12 dual-function keys for easy setup

Display
40 character, 2 line (20x2) lattice alphanumeric, backlit LCD

Humidity
Up to 99% RH (non-condensing)

PHYSICAL SPECIFICATIONS

Transmitter
NEMA 4X, IP 65 (PC/ABS)

Transducer
Encapsulated design IP 68
Standard cable length: 30 ft (9 m)
Maximum cable length: 100 ft (30 m)

Weight
Transmitter: approximately 1.5 lb. (.7 kg)
Transducer: approximately 0.9 lb. (0.4 kg)

DIMENSIONS

Front View 203 Transmitter

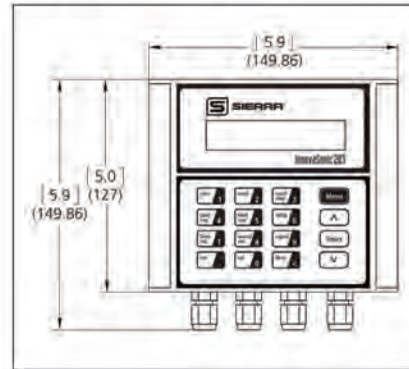

Side View 203 Transmitter

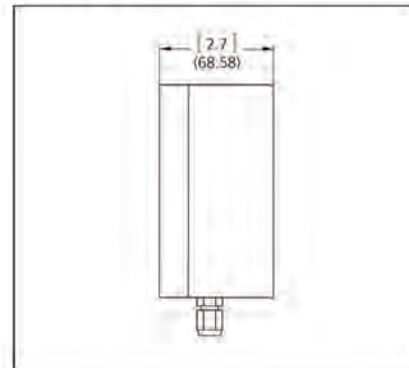

Front View Clamp-on Transducers



OPTIMAL INSTALLATION LOCATIONS

Transducer Installation Examples

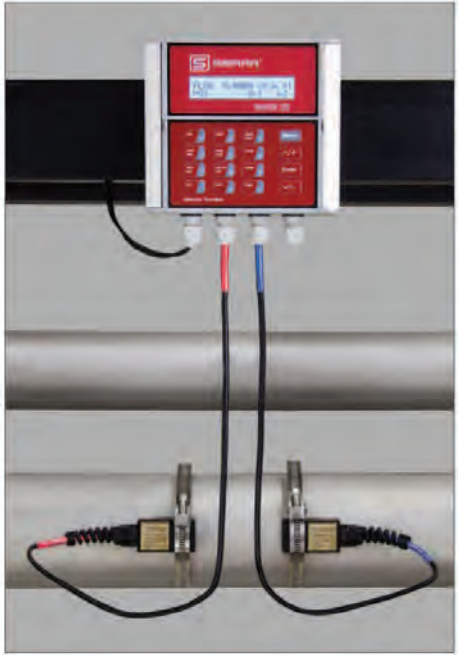
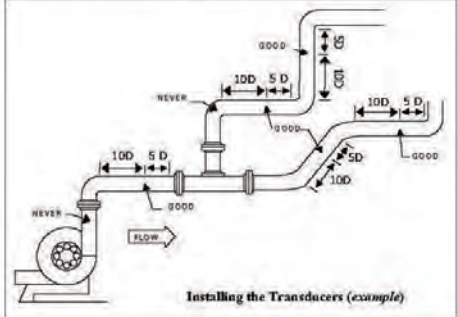

TRANSDUCER SPACING REQUIREMENTS

Z Method Transducer Spacing

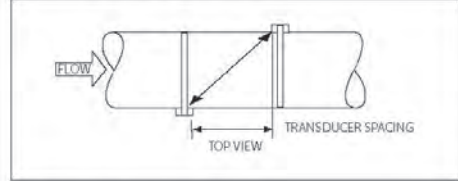

V Method Transducer Spacing

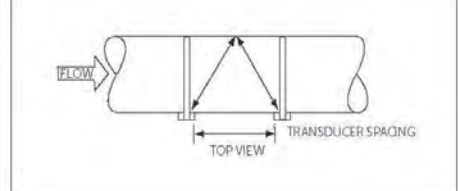

ORDERING THE INNOVASONIC® 203

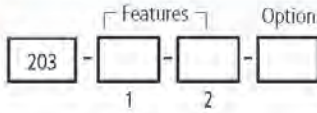

Instructions: To order the 203, please fill in each number block by selecting the codes from the corresponding features below.

Select Model	
203	InnovaSonic 203® Economical ultrasonic transit time liquid flow meter; clamp-on transducers (CP) included in base price.

Feature 1: Outputs	
4	OCT, Relay, RS-485, 4 to 20 mA current loop (max load 750 Ω), Modbus RTU (all included)

Feature 2: Transducers	
CP	Clamp on transducers included. Installation kit includes two 2 inch x 44 inches (50 mm x 1115 mm) pipe straps suitable for 12 inch (304.8 mm) pipe max diameter pipe. Customer is responsible for connection to larger pipes.. Operating temperature 32°F to 140°F (0°C to 60°C). Standard 30 ft. (9 m). Note: Transducers included in base price.

Optional NIST Traceable Cert. from:	
NIST	5-point calibration certification traceable to NIST. Add two weeks to standard delivery.

9. Appendix1-Serial Interface Network Use and Communications Protocol

9.1 Overview

The flow meter comes standard with a RS-485 multi-drop communication port. An option RS-232 communication connection is available as a special. RS-232 can be used for point to point (one master one slave 203) communication only with wire runs of 50 feet or less. The RS-485 can be used to communicate over 1,000 meters baud rate dependent with several 203 slaves on one wire pair. This could be up to 30, 203s on one RS-485 segment, and 127 on a whole RS-485 network.

When the RS-485 communication method is used to implement a monitoring system network, the address identification code (in menu M46) of the flow meter is used to set the Network ID in the 203 slave.

When using digital commutations the analog current loop and OCT output of flow meter can be free to be used to control the opening of a control valve. The relay output can be used to power-on/off other equipment. The analog input of the system can be used to input signals such as pressure and temperature. These analog values can be read using the Modbus RTU protocol to be used by customer software.

RS-232 (<50 ft.) or RS-485 (up to 4,000 ft.) can be directly used for data transmission link for a short distance. Current loop, radio transmission and modems can be used in medium or very long distance transmission.

When the flow meter is used in a network environment, various operations can be performed at the host device, except for programming of the address identification code, which needs to be done at the flow meter keyboard. The command answer mode is used in data transmission, i.e. the host device issues commands and the flow meter answers correspondingly (polling communications).



ATTENTION

RS-232 and RS-485 serial communications cannot be used at the same time.

9.2 Serial Port Pin Definitions

Flow meter RS-232:

- TXD receive
- RXD send
- GND

PC 9 pin Com Port:

- PIN 1 empty
- PIN 2 RXD receive
- PIN 3 TXD send
- PIN 4 ground

PIN 5 ground

Optional RS-485:

Tx=A- (note, A & B may be reversed on some equipment)

Rx=B+

GND=RS-485 common

9.3 Connection to RS-232/RS-485 Host Device

See the below figure flow meter serial port wiring.

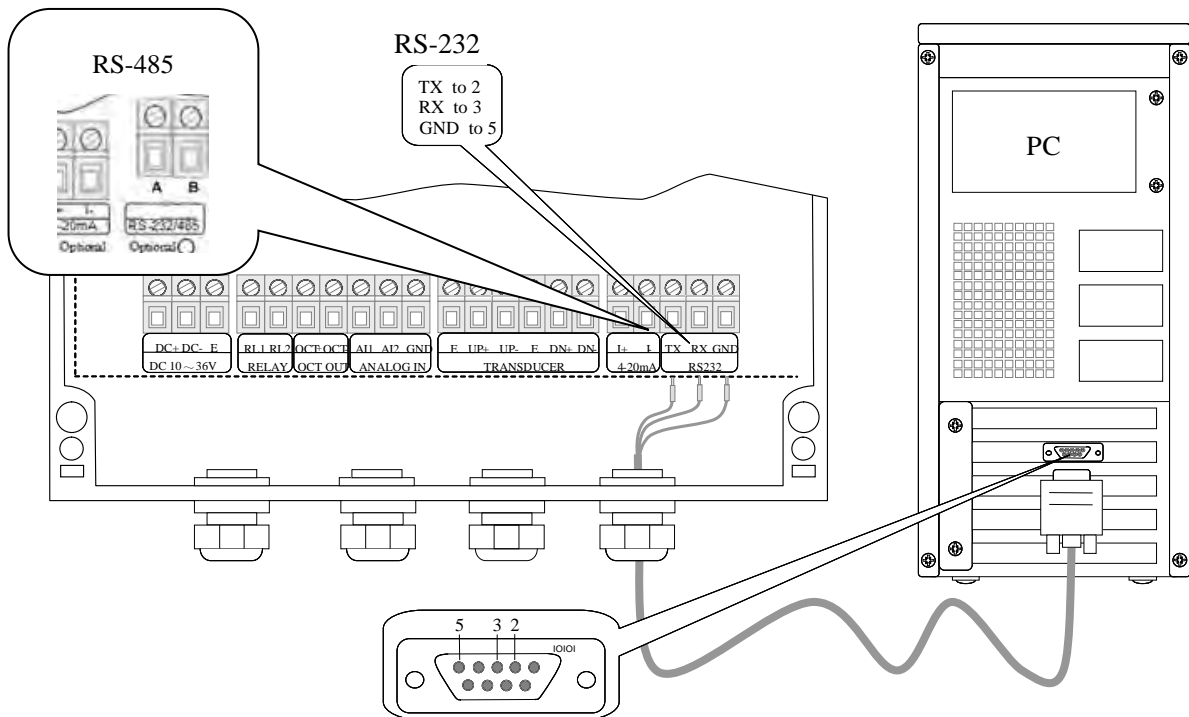

Figure 9. Connecting RS-232/RS-242 Direct to Host Device



The serial port baud rate settings of the 203 must be consistent with the host device and are set in Menu 62. The first selected data indicates baud rate, 9600, 19200, 38400, 56000, 57600, 115200 are available.

Parity fixed at None

Data length fixed at 8

Stop Bits fixed at 1

The factory default serial port parameter is “9600, None



Network IDN

This is the 203 salve address. Normally this is not used on RS-232, however when using Modbus host software you will still need to set this address. The range of flow meter addresses 1 to 247 (Hex 1~0xF7), an

d can be set in Menu 46. Numbers 13, 10, 42, and 38 are reserved and cannot be used.

9.4 Modbus-RTU Communication Protocol

This Modbus-I Protocol uses RTU transmission mode. The Verification Code uses CRC-16-IBM (polynomial is $X^{16}+X^{15}+X^2+1$, shield character is 0xA001) which is gained by the cyclic redundancy algorithm method.

Modbus RTU mode uses hexadecimals to transmit data.

1) Modbus-I Protocol Function Code and Format

The flow meter protocol supports the following two-function codes of the Modbus:

Function Code	Performance data
0x03	Read register
0x06	Write single register

2) Modbus Protocol function code 0x03 usage

The host sends out the read register information frame format:

Slave Address	Operation Function Code	First Address Register	Register Number	Verify Code
1 byte	1 byte	2 bytes	2 bytes	2 bytes
0x01~0xF7	0x03	0x0000~0xFFFF	0x0000~0x7D	CRC(Verify)

The slave returns the data frame format:

Slave Address	Read Operation Function Code	Number of Data Bytes	Data Bytes	Verify Code
1 byte	1 byte	1 byte	N*x2 byte	2 byte
0x01~0xF7	0x03	2xN*	N*x2	CRC(Verify)

N*=data register number

3) Modbus Protocol function code 0x06 usage

The host sends a command to write a single register information frame format (performance code 0x06):

Slave Address	Operation Function Code	Register Address	Register Data	Verify Code
1 byte	1 byte	2 bytes	2 bytes	2 bytes
0x01~0xF7	0x06	0x0000~0xFFFF	0x0000~0xFFFF	CRC(Verify)

The slave returns the data frame format (performance code 0x06):

Slave Address	Operation Function Code	Register Address	Register Data	Verify Code
1 byte	1 byte	2 bytes	2 bytes	2 bytes

0x01~0xF7	0x06	0x0000~0xFFFF	0x0000~0xFFFF	CRC(Verify)
-----------	------	---------------	---------------	-------------

The range of flow meter addresses 1 to 247 (Hexadecimal: 0x01~0xF7), and can be checked in the Menu 46. For example, decimal number “11” displayed on Menu 46 means the address of the flow meter in the Modbus protocol is 0x0B.

The CRC Verify Code adopts CRC-16-IBM (polynomial is $X^{16}+X^{15}+X^2+1$, shield character is 0xA001) which is gained by the cyclic redundancy algorithm method. Low byte of the verify code is at the beginning while the high byte is at the end.

For example, to read the address 1 (0x01) in the RTU mode, if the instantaneous flow rate uses hour as a unit (m³/h), namely reads 40005 and 40006 registers data, the read command is as follows:

0x01	0x03	0x00 0x04	0x00 0x02	0x85 0xCA
Flow meter Address	Function Code	Register Address	Register Numbers	CRC Verify Code

Flow meter returned data is (assuming the current flow = 1.234567m³/h)

0x01	0x03	0x04	0x06 0x51 0x3F 0x9E	0x3B 0x32
Flow meter Address	Function Code	Data Bytes	Data (1.2345678)	CRC Verify Code

The four bytes 3F 9E 06 51 is in the IEEE754 format single precision floating point form of 1.2345678.

Pay attention to the data storage order of the above example. Using C language to explain the data, pointers can be used directly to input the required data in the corresponding variable address, the low byte will be put at the beginning, such as the above example 1.2345678 m/s, 3F 9E 06 51 data stored in order as 51 06 9E 3F.

For example, it converts the address 1 (0x01) to 2 (0x02) under the RTU mode, so to write the data of flow meter 44100 register as 0x02, the write command is as follows:

0x01	0x06	0x10 0x03	0x00 0x02	0xFC 0xCB
Flow meter Address	Function Code	Register Address	Register Numbers	CRC Verify Code

Flowmeter returned data is:

0x01	0x06	0x10 0x03	0x00 0x02	0xFC 0xCB
Flow meter Address	Function Code	Register Address	Register Numbers	CRC Verify Code

4) Error Check

The flow meter only returns one error code 0x02 which means data first address in error.

For example, to read address 1 (0x01) of the flow meter 40002 register data in the RTU mode, the flow meter considers it to be invalid data, and sends the following command:

0x01	0x03	0x00 0x01	0x00 0x01	0xD5 0xCA
Flow meter Address	Function Code	Register Address	Register Numbers	CRC Verify Code

Flow meter returned error code is:

0x01	0x83	0x02	0xC0 0xF1
------	------	------	-----------

Flow meter Address	Error Code	Error Extended Code	CRC Verify Code
--------------------	------------	---------------------	-----------------

5) Modbus Register Address List

Most commercially available Modbus host software uses a register format. See Modbus.org for more details. This format is much easier to use. By using the 40000 registers, function code Ox 03 is automatically used for reads and function code Ox 06 is automatically used for single register writes. The CRC checksum is also automatically calculated and added to the data frame, as well as verified on the returned data frame. Error codes are received and decoded.

Modbus host software also allows for easy decoding of the data. The 203 uses the following data types:

32 bits real: Float or IEE754 (LSB-MSB byte order)

32 bits int.: 32 bit un-signed integer. Allows for a number from 0 to 4,294,967,295 (LSB-MSB byte order)

16 bits int: 16 bit signed integer. This allow for a number between -65,535 and +65,534

String: 8 bit ASCII characters, 2 per 16 bit register.

Modbus Register Table

PDU Address	Register	Read	Data Type	No. Registers	Notes
\$0000	40001	Flow/s - low word	32 bits real	2	
\$0001	40002	Flow/s - high word			
\$0002	40003	Flow/m - low word	32 bits real	2	
\$0003	40004	Flow/m- high word			
\$0004	40005	Flow/h - low word	32 bits real	2	
\$0005	40006	Flow/h - high word			
\$0006	40007	Velocity – low word	32 bits real	2	
\$0007	40008	Velocity – high word			
\$0008	40009	Positive total – low word	32 bits int.	2	
\$0009	40010	Positive total – high word			
\$000A	40011	Positive total – exponent	16 bits int.	1	
\$000B	40012	Negative total – low word	32 bits int.	2	
\$000C	40013	Negative total – high word			
\$000D	40014	Negative total – exponent	16 bits int.	1	
\$000E	40015	Net total – low word	32 bits int.	2	
\$000F	40016	Net total – high word			
\$0010	40017	Net total – exponent	16 bits int.	1	
\$0011	40018	Reserved – low word	32 bits int.	2	
\$0012	40019	Reserved – high word			
\$0013	40020	Reserved – exponent	16 bits int.	1	
\$0014	40021	Reserved – low word	32 bits real	2	
\$0015	40022	Reserved – high word			
\$0016	40023	Up signal int – low word	32 bits real	2	0~99.9
\$0017	40024	Up signal int – high word			
\$0018	40025	Down signal int – low word	32 bits real	2	0~99.9
\$0019	40026	Down signal int – high word			

\$001A	40027	Quality	16 bits int.	1	0~99
\$001B	40028	Analog output – low word	32 bits real	2	Unit: mA
\$001C	40029	Analog output – high word			
\$001D	40030	Error code – char 1,2	String	3	Refer to “Error Analysis” for detailed codes meanings.
\$001E	40031	Error code – char 3,4			
\$001F	40032	Error code – char 5,6			
\$003B	40060	Velocity unit – char 1,2	String	2	Currently supports m/s only
\$003C	40061	Velocity unit – char 3,4			
\$003D	40062	Flow unit – char 1,2	String	2	Note 1
\$003E	40063	Flow unit – char 3,4			
\$003F	40064	Total unit – char 1,2	String	1	
\$0040	40065	Reserved – char 1,2	String	2	Note 2- the setup is same as M84 and M85
\$0041	40066	Reserved – char 3,4			
\$0042	40067	Reserved – char 1,2	String	1	
\$0049	40074	Analog Input AI1 Value- low word	32 bits real	2	Returned temperature value with RTD option
\$004a	40075	Analog Input AI1 Value- high word			
\$004b	40076	Analog Input AI2 Value- low word	32 bits real	2	Returned temperature value with RTD option
\$004c	40077	Analog Input AI2 Value- high word			
\$004d	40078	Reserved - low word	32 bits int.	2	
\$004e	40079	Reserved - high word			
\$004f	40080	Reserved - exponent	16 bits int.	1	
\$0050	40081	Reserved - low word	32 bits int.	2	
\$0051	40082	Reserved - high word			
\$0052	40083	Reserved - exponent	16 bits int.	1	

Notes:

1. The following flow rate units are available:
 0. “m3” – Cubic Meter
 1. “l” – Liters
 2. “ga” – Gallons
 3. “ig” – Imperial Gallons
 4. “mg” – Million Gallons
 5. “cf” – Cubic Feet
 6. “ba” – US Barrels
 7. “ib” – Imperial Barrels
 8. “ob” – Oil Barrels
2. When the flow meter address or communication baud rate is changed, the meter will work under the new settings after the flow meter responds to the new address and baud rate.

10. Appendix2-Warranty Policy

10.1 Limited Warranty Policy- Register Online

All Sierra products are warranted to be free from defects in material and workmanship and will be repaired or replaced at no charge to Buyer, provided return or rejection of product is made within a reasonable period but no longer than one (1) year for calibration and non-calibration defects, from date of delivery. To assure warranty service, customers must register their products online on Sierra's website. Online registration of all of your Sierra products is required for our warranty process. Register now at www.sierrainstruments.com/register. Learn more about Sierra's warranty policy at www.sierrainstruments.com/warranty.