



InnovaSonic[®] 207i BACnet

Instruction Manual

BACnet Device Specification for
207i Ultrasonic Liquid Flow Meter

Version IM-207i-BACnet V2.3/19



SIERRA[®]

GLOBAL SUPPORT LOCATIONS: WE ARE HERE TO HELP!

For Global Service Centers, go to <http://www.sierrainstruments.com/facilities.html>

CORPORATE HEADQUARTERS

5 Harris Court, Building L, Monterey, CA 93940

Phone (831) 373-0200 (800) 866-0200 Fax (831) 373-4402

info@sierrainstruments.com

www.sierrainstruments.com

EUROPE HEADQUARTERS

Bijlmansweid 2
1934RE Egmond aan den Hoef

The Netherlands

Phone +31 72 5071400 Fax +31 72 5071401

sales@sierrainstruments.nl

ASIA HEADQUARTERS

Second Floor Building 5, Senpu Industrial Park
25 Hangdu Road Hangtou Town

Pu Dong New District, Shanghai, P.R. China
Postal Code 201316

Phone: + 8621 5879 8521 Fax: +8621 5879 8586

© COPYRIGHT SIERRA INSTRUMENTS 2019

No part of this publication may be copied or distributed, transmitted, transcribed, stored in a retrieval system, or translated into any human or computer language, in any form or by any means, electronic, mechanical, manual, or otherwise, or disclosed to third parties without the express written permission of Sierra Instruments. The information contained in this manual is subject to change without notice.

TRADEMARKS



InnovaSonic® is a Registered Trademark of Sierra Instruments, Inc. Other product and company names listed in this manual are trademarks or trade names of their respective manufacturers.

Table of Contents





1	Introduction	7
1.1	BACnet MS/TP Description	7
2	BACnet Module Installation	8
2.1	Overview RS-485 Network	8
2.2	Baud Rate and MAC Address Configuration	9
2.3	Attaching Module Board to Network	9
2.4	BACnet Field Installation	10
3	InnovaSonic 207i Com Settings	11
3.1	Configure Baud Rate and MAC Address with Smart Interface Portal (SIP)	11
3.2	Configure Baud Rate and MAC Address Using Local Display and Keypad	13
4	Supported BACnet Services/Objects (PICS)	16
4.1	Acronyms and Definitions.....	16
4.2	Supported BACnet Services/Objects	17
4.3	BACnet Supported Device, Object and Property Table	17
4.4	Analog Input and Analog Value	27
5	BACnet Engineering Units	29
5.1	Units Not Supported By BACnet	29
6	Troubleshooting Tips	31
6.1	Other Troubleshooting Tips	31

Warnings in This Manual







“Warning,” “Attention,” and “Note” statements are used throughout this manual to draw your attention to important information.

Symbol Key		
Symbol	Symbol Meaning	Description
	Warning	“Warning” statements appears with information that is important to protect people and equipment from damage. Pay very close attention to all warnings that apply to your application. Failure to comply with these instructions may damage the meter and cause personal injury.
	Caution	“Attention” indicates that failure to comply with stated instructions may result in damage or faulty operation of the meter.
	Note	“Note” indicates that ignoring the relevant requirements or precautions may result in flow meter damage or malfunction.

General Warning Information

Symbol	Description
	To avoid potential electric shock, follow National Electric Code safety practices or your local code when wiring this unit to a power source and to peripheral devices. Failure to do so could result in injury or death. All AC power connections must be in accordance with published CE directives.
	Do not power the flow meter with the sensor remote (if applicable) wires disconnected. This could cause over-heating of the sensors and/or damage to the electronics
	All wiring procedures must be performed with the power off.
	Before attempting any flow meter repair, verify that the line is de-pressurized Agency approval for hazardous location installations varies between flow meter models. Consult the flow meter nameplate for specific flow meter approvals before any hazardous location installation.

General Caution Information

	<p>The AC wire insulation temperature rating must meet or exceed 80°C (176°F).</p>
	<p>Printed circuit boards are sensitive to electrostatic discharge. To avoid damaging the board, follow these precautions to minimize the risk of damage:</p> <ul style="list-style-type: none"> - before handling the assembly, discharge your body by touching a grounded, metal object - handle all cards by their edges unless otherwise required - when possible, use grounded electrostatic discharge wrist straps when handling sensitive component
	<p>Before making adjustments to the device, verify the flow meter is not actively monitoring or reporting to any master control system. Adjustments to the electronics will cause direct changes to flow control settings.</p>
	<p>All flow meter connections, isolation valves and fittings for hot tapping must have the same or higher-pressure rating as the main pipeline.</p>
	<p>Changing the length of cables or interchanging sensors or sensor wiring will affect the accuracy of the flow meter. You cannot add or subtract wire length without returning the meter to the factory for re-calibration.</p>
	<p>When using toxic or corrosive gases, purge the line with inert gas for a minimum of four hours at full gas flow before installing the meter.</p>

Receipt of System Components

When receiving a Sierra mass flow meter, carefully check the outside packing carton for damage incurred in shipment. If the carton is damaged, notify the local carrier and submit a report to the factory or distributor. Remove the packing slip and check that all ordered components are present. Make sure any spare parts or accessories are not discarded with the packing material. Do not return any equipment to the factory without first contacting Sierra Customer Service.

Technical Assistance

If you encounter a problem with your flow meter, review the configuration information for each step of the installation, operation, and setup procedures. Verify that your settings and adjustments are consistent with factory recommendations. Installation and troubleshooting information can be found in the [InnovaSonic 207i Product Instruction Manual](#).

If the problem persists after following the troubleshooting procedures outlined in the 207i product manual, contact Sierra Instruments by fax or by email (see inside front cover for contact information). For urgent phone support, you may call (800) 866-0200 or (831) 373-0200 between 8:00 a.m. and 5:00 p.m. PST. In Europe, contact Sierra Instruments Europe at +31 20 6145810. In the Asia-Pacific region, contact Sierra Instruments Asia at +86-21-58798521. When contacting Technical Support, make sure to include this information:

- The flow range, serial number, and Sierra order number (all marked on the meter nameplate)
- The software version (visible at start up)
- The problem you are encountering, and any corrective action taken
- Application information (gas, pressure, temperature and piping configuration)

Register Your Product Today

Warranty Statement

All Sierra products are warranted to be free from defects in material and workmanship and will be repaired or replaced at no charge to Buyer, provided return or rejection of product is made within a reasonable period but no longer than one (1) year for calibration and non-calibration defects, from date of delivery. To assure warranty service, customers must register their products online on Sierra's website. Online registration of all of your Sierra products is required for our warranty process. Read complete warranty policy at www.sierrainstruments.com/warranty.

Register Warranty Online

Register now at www.sierrainstruments.com/register. Learn more about Sierra's warranty policy at www.sierrainstruments.com/warranty

1 Introduction

This document describes the set-up, function and operation of the BACnet digital communications protocol for Sierra Instruments' InnovaSonic 207i ultrasonic liquid flow meter. This manual assumes the reader already has a working knowledge of BACnet protocol requirements and terminology. For specific information about the InnovaSonic 207i ultrasonic flow meter, consult the [InnovaSonic 207i Instruction Manual](#). For all InnovaSonic 207i documentation, go to: sierrainstruments.com/downloads/207i.

1.1 BACnet MS/TP Description

BACnet is a communications protocol for Building Automation and Control (BAC) networks that is governed by the American Society of Heating, Refrigerating and Air-Conditioning Engineers (ASHRAE), SSPC 135, ANSI, and ISO 16484-5 standard protocol.

The BACnet Master/Slave/Token-Passing (MS/TP) driver implements a data link protocol that uses the services of the RS-485 physical layer. The MS/TP bus is based on BACnet standard protocol SSPC - 135, Clause 9. BACnet MS/TP protocol is a peer-to-peer, multiple master protocol based on token passing. Only master devices can receive the token, and only the device holding the token is allowed to originate a message on the bus. The token is passed from master device to master device using a small message in consecutive order starting with the lowest address. Slave devices on the bus only communicate when responding to a data request from a master device.

2 BACnet Module Installation

2.1 Overview RS-485 Network

BACnet MS/TP uses a RS-485 (EIA-485) physical layer, so all of the same RS-485 wiring practices apply. Devices should be wired using a daisy chain topology and the last device should have one 120Ω termination resistor to prevent reflections. RS-485 repeaters may be used to exceed 30 devices or to clean up the signal. In some cases, a pull up and pull down resistor may be used to “stiffen” the bus bias, although most devices have some built in (See Figure 1). Although the BACnet MS/TP uses the RS-485 physical layer, the different data link layer allows any device to be a master or a slave.

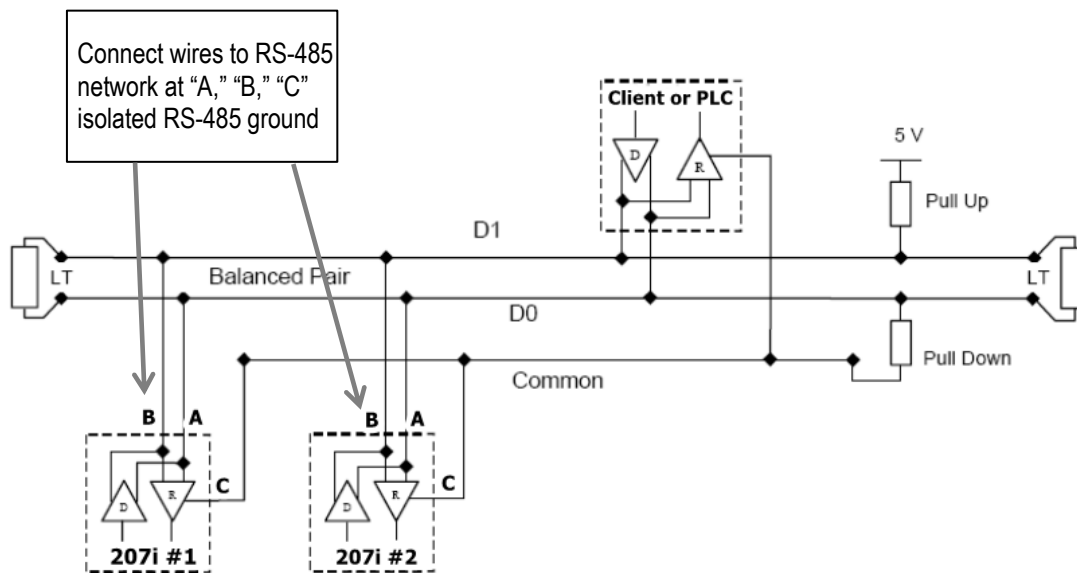

Figure 1. Overview of BACnet RS-485 Network

2.2 Baud Rate and MAC Address Configuration

The baud rate and MAC (MS/TP) addresses can be set by either using the 207i Smart Interface Portal (SIP) Software, which is recommended, or the local display and keypads on the meter. Download the 207i SIP software at sierrainstruments.com/downloads/207i. See Chapter 3 for SIP and local display complete configuration instructions.



CAUTION | When configuring BACnet, it is very important that all of the devices on an MS/TP bus communicate at the same baud rate: 9600, 19200 and 38400. Configure the MAC (MS/TP) address between 1 to 127.



WARNING | Due to the way BACnet token passing works, duplicate addresses may lock up the entire network and require a re-boot to restore full network functions.

2.3 Attaching BACnet Module Board to Network

BACnet is normally installed in slot 12 of the terminal board (See Figure 2 below). To set up the physical layer, connect your network wires to the RS-485 connections which are A-, B+, C isolated RS-485 ground. Follow all RS-485 wiring practices (See Figure 1 and Figure 2). The BACnet board has one dual LED that helps during troubleshooting. The “RX” and “TX” markings are not relevant for BACnet. A red LED (solid or blinking) indicates the BACnet board is not talking to the 207i main board. A green blinking LED light indicates the 207i is communicating between the main board and BACnet board (See Chapter 6, for troubleshooting details).

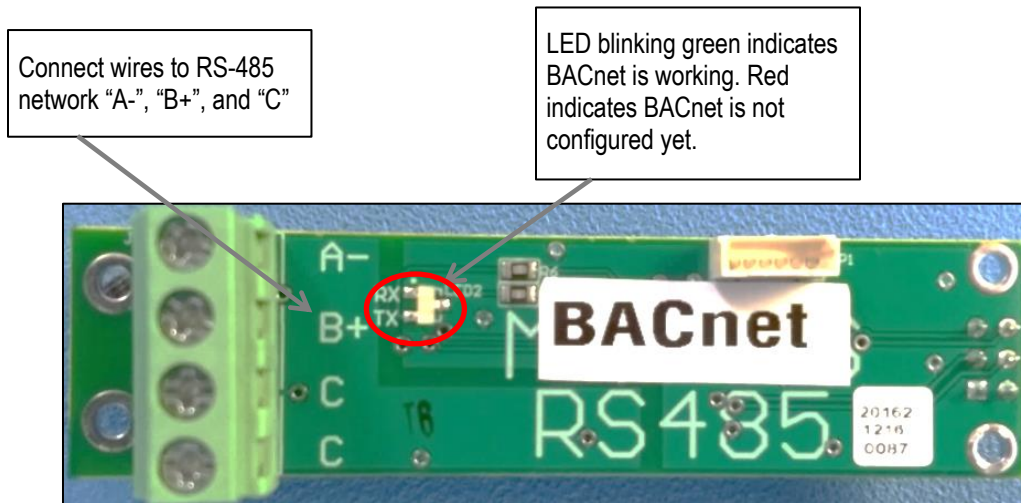

Figure 2. Standard BACnet Module Located in Slot 12 of Terminal Board

2.4 BACnet Field Installation

As stated, BACnet is usually installed in slot 12. However, the BACnet module can be installed in any free slot on the board. Users may install their BACnet module in the field as standard with other option modules. The module has 4 plastic screws, one on each corner that are used to mount the module. The electrical power connections to the 207i are made through the 4-pin connector (See Figure 3). Make sure to power down the 207i before installing any module. Plug the BACnet Module into an open slot, (slot 12 normally) and secure it with the four plastic screws provided. You will need to temporarily remove the LCD to access the back two screws.

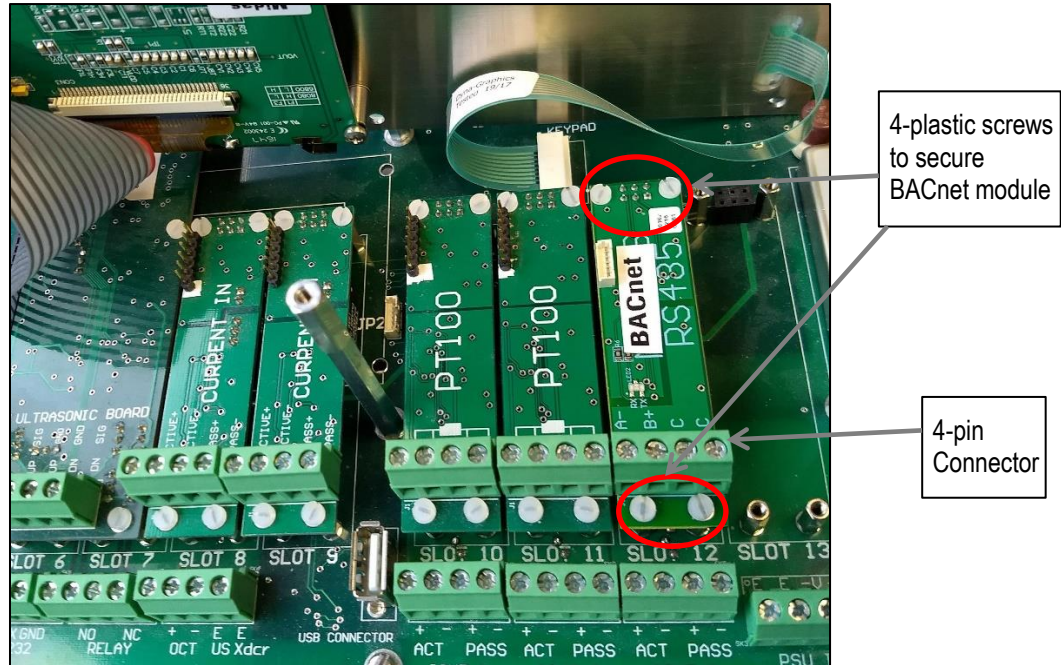

Figure 3. BACnet Module Field Installation

As stated in Section 2.2, configuration of the RS-485 (MAC) address and baud rate, is done either with the 207i Smart Interface Portal Software (SIP) or the local keyboard on the meter. See Chapter 3 for SIP and local display configuration instructions.

	Warning Only install 207i option Modules with the 207i powered off and use proper ESD precautions.
--	---

3 InnovaSonic 207i Com Settings

3.1 Configure Baud Rate and MAC Address with Smart Interface Portal (SIP)

To configure the baud rate and MAC MS/TP with the 207i Smart Interface Portal Software (SIP) follow the steps below:

	NOTE BACnet is available on SIP Version 1.3.4 or higher. The latest SIP software version can be downloaded on Sierra's website at sierrainstruments.com/207isoftware .
---	---

1. Download the SIP software on the Sierra website at sierrainstruments.com/207isoftware.
2. Connect the 207i to your computer via the USB cable provided in your shipment. For more details on SIP installation, refer to the [207i SIP Instruction Manual, Chapter 1](#).

	CAUTION If installing the BACnet in the field after initial installation of the product, the 207i software may need to be updated. Go to sierrainstruments.com/207isoftware .
---	--

3. Once your SIP is initialized, open your Smart Interface Portal (SIP) application and click the “Master Setup” button.



Figure 4. InnovaSonic 207i Smart Interface Portal Main Menu

4. Click on “BACnet MS/TP Setup” button.

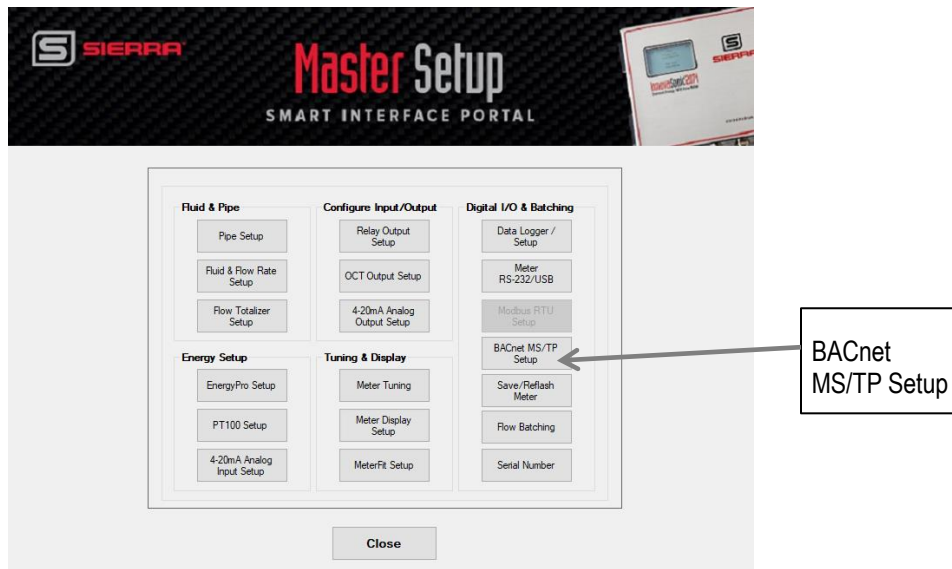

Figure 5. 207i SIP BACnet MS/TP Setup

5. In the “BACnet MS/TP Setup” screen, complete the configuration of your 207i for BACnet by doing the following:



WARNING | Due to the way BACnet token passing works, duplicate addresses may lock up the entire network and require a re-boot to restore full network functions.

- 1) Select “On” in the “Off/On/Text” field.
- 2) Type in the BACnet MAC address in the “Address” field. Acceptable number range 1 to 127.
- 3) Choose your “Baud Rate”: 9600, 19200, or 38400.



CAUTION | When configuring BACnet, it is very important that all of the devices on an MS/TP bus communicate at the same baud rate: 9600, 19200 and 38400. Configure the MAC (MS/TP) address between 1 to 127.

- 4) Once done, click the “Update Meter” button.

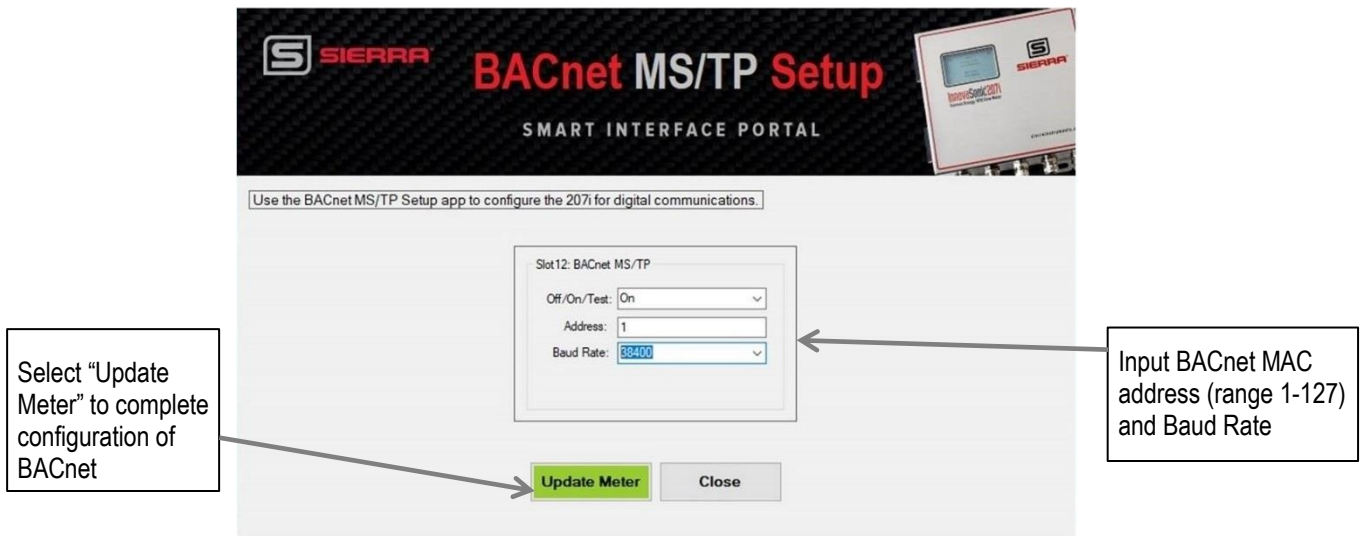



Figure 6. BACnet MS/TP Set Up For MAC Address and Baud Rate

3.2 Configure Baud Rate and MAC Address Using Local Display and Keypad

To configure the Baud Rate and MAC address using the local display and keypad on the meter, follow the steps below:

1. Press the  key. Pressing the  key will bring you the top of the “MAIN MENU.”



2. From the “MAIN MENU,” scroll down to the “Input/Output” menu and press the  key.
NOTE: Only three menu options show on the screen at a time.

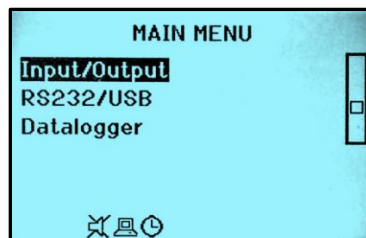

3. Once in the “Input/Output” menu, scroll down and select “Slot 12 BACnet” and press the  key. You will now be in the BACnet setup menu. Note: There will be a series of screens in this section to complete the configuration of BACnet to your 207i.

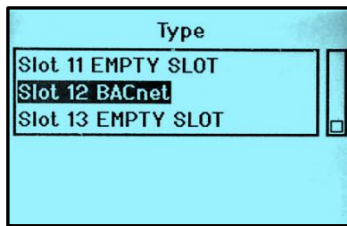

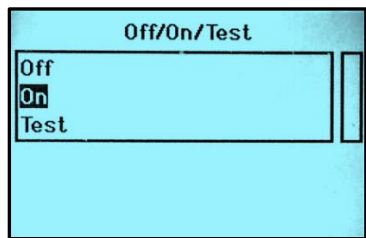

4. The next menu screen in the BACnet setup area is the “Off/On/Test” menu. Scroll down and select “On” to turn on the BACnet Module. Press  to go to “Address” screen.





5. Once in the BACnet MAC “Address” menu type in your MAC address. Acceptable address range from 1 to 127. Press  to go the next menu screen “Baud” in the BACnet setup menu.

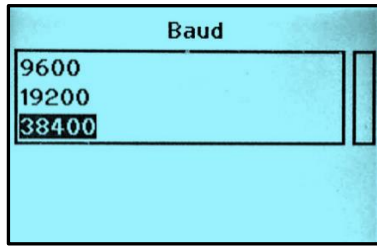

WARNING | Due to the way BACnet token passing works, duplicate addresses may lock up the entire network and require a re-boot to restore full network functions.

6. Once in the “Baud” menu screen, scroll down and select your baud rate of either 9600, 19200, or 38400 and press the  key. Press  to go the next menu screen “Parity” in the BACnet setup menu.



 **CAUTION** | When configuring BACnet, it is very important that all of the devices on an MS/TP bus communicate at the same baud rate: 9600, 19200 and 38400. Configure the MAC (MS/TP) address between 1 to 127.

7. Leave “Parity” on “None,” and press the  key twice to return to the “MAIN MENU.”

 **NOTE** | The “Parity” is always “None” regardless of the menu’s selection.

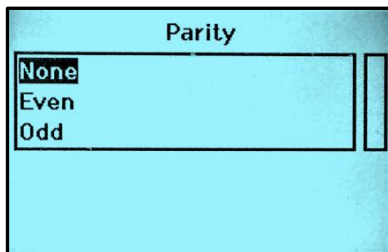

4 Supported BACnet Services/Objects - Protocol Implementation Conformance Statement (PICS)

A BACnet object represents physical or virtual equipment information, as a digital input or parameter. The InnovaSonic 207i ultrasonic flow meter uses the following object types:

- Device Object (1)
- Analog Input (23)
- Analog Value (1)

Each object type defines a data structure composed by properties that allow access to the object information. The tables on the following pages show the implemented properties for each InnovaSonic 207i flow meter.

4.1 Acronyms and Definitions

Acronyms and Definitions	
Item	Description
APDU	Application Protocol Data Unit
BACnet	Building Automation and Control Network---Data communication protocol
MS/TP	Master---Slave Token passing (a twisted pair RS-485 network created by BACnet)
BIBB	BACnet Interoperability Building Block (Specific individual function blocks for data exchange between interoperable devices).
BV	Binary Value
BI	Binary Input
AI	Analog Input
RP	Read Property
WP	Write Property
RPM	Read Property Multiple
WPM	Write Property Multiple
DDP	Dynamic Device Binding
DOP	Dynamic Object Binding

DCC	Device Communication Control
PICS	Protocol Implementation Conformance Statement

4.2 Supported BACnet Services/Objects

Supported BACnet Services/Objects		
BACnet Interoperability Building Block	Services	Support
DS-RP-B	Read Property	Execute
DS-WP-B	Write Property	Execute
DM-DDB-B	Read Property Multiple	Execute
DM-DOB-B	Write Property Multiple	Execute
DM-DCC-B	Who-Is	Execute
DS-RPM-B	I-Am	Initiate
DS-WPM-B	Who-Has	Execute
DS-RP-B	I-Have	Initiate
DS-WP-B	Device Communication Control	Execute

4.3 BACnet Supported Device, Object and Property Table

BACnet Object Name	Obj, Instance	BACnet Object Property	Default/Sample Values
Sierra 207i	Dev, 1	Object Identifier	MAC
		Object Name	207i Flowmeter
		Object Type	Flowmeter
		System Status	Operational
		Vendor Name	Sierra Instruments
		Vendor Identifier	ASHRA# 722
		Model Name	207i
		Firmware Revision	v1.x.xx
		Application Software Version	v1.x.xx
		Location	*TAG as set in 207i menu

BACnet Object Name	Obj, Instance	BACnet Object Property	Default/Sample Values
		Description	*TAG as set in 207i menu
		Protocol Version	1
		Protocol Revision	12
		Protocol Services Supported	
		Protocol Object Types Supported	
		Object List	
		Max APDU Length Accepted	480
		Segmentation Supported	No
		APDU Timeout	6000
		Number Of APDU Retries	3
		Max Master	127
		Max Info Frames	1
		Device Address Binding	
		Database Revision	0
Flow	AI, 1	Object Identifier	AI-1
		Object Name	Flow
		Object Type	Analog Input
		Present Value	0
		Description	Current Flow Rate
		Status Flags	F,F,F,F { }
		Event State	NORMAL
		Out Of Service	0
		Units	* as selected in 207i menu
Velocity	AI, 2	Object Identifier	AI-2
		Object Name	Velocity

BACnet Object Name	Obj, Instance	BACnet Object Property	Default/Sample Values
		Object Type	Analog Input
		Present Value	0
		Description	Current Velocity of Fluid
		Status Flags	F,F,F,F { }
		Event State	NORMAL
		Out Of Service	0
		Units	meters_per_second
POS Totalizer	AI, 3	Object Identifier	AI-3
		Object Name	POS Totalizer
		Object Type	Analog Input
		Present Value	0
		Description	POS Flow Total
		Status Flags	F,F,F,F { }
		Event State	NORMAL
		Out Of Service	0
		Units	* as selected in 207i menu
NEG Totalizer	AI,4	Object Identifier	AI-4
		Object Name	NEG Totalizer
		Object Type	Analog Input
		Present Value	0
		Description	NEG Flow total
		Status Flags	F,F,F,F { }
		Event State	NORMAL
		Out Of Service	0
		Units	* as selected in 207i menu

BACnet Object Name	Obj, Instance	BACnet Object Property	Default/Sample Values
NET Totalizer	AI, 5	Object Identifier	AI-5
		Object Name	NET Totalizer
		Object Type	Analog Input
		Present Value	0
		Description	Net Flow Total of Fluid
		Status Flags	F,F,F,F { }
		Event State	NORMAL
		Out Of Service	0
		Units	* as selected in 207i menu
Energy Flow Rate	AI,6	Object Identifier	AI-6
		Object Name	Energy Flow Rate
		Object Type	Analog Input
		Present Value	0
		Description	Energy Flow Rate of Fluid
		Status Flags	F,F,F,F { }
		Event State	NORMAL
		Out Of Service	0
		Units	* as selected in 207i menu
Energy POS Total	AI,7	Object Identifier	AI-7
		Object Name	+ Energy Tot
		Object Type	Analog Input
		Present Value	0
		Description	Energy Positive Total
		Status Flags	F,F,F,F { }
		Event State	NORMAL

BACnet Object Name	Obj, Instance	BACnet Object Property	Default/Sample Values
		Out Of Service	0
		Units	* as selected in 207i menu
Energy NEG Total	AI,8	Object Identifier	AI-8
		Object Name	-Energy Tot
		Object Type	Analog Input
		Present Value	0
		Description	Energy Negative Total
		Status Flags	F,F,F,F { }
		Event State	NORMAL
		Out Of Service	0
		Units	* as selected in 207i menu
Energy NET Total	AI,9	Object Identifier	AI-9
		Object Name	Net Energy Tot
		Object Type	Analog Input
		Present Value	0
		Description	Energy Net Total
		Status Flags	F,F,F,F { }
		Event State	NORMAL
		Out Of Service	0
		Units	* as selected in 207i menu
Delta Time	AI,10	Object Identifier	AI-10
		Object Name	Dt
		Object Type	Analog Input
		Present Value	0
		Description	Delta Time

BACnet Object Name	Obj, Instance	BACnet Object Property	Default/Sample Values
		Status Flags	F,F,F,F { }
		Event State	NORMAL
		Out Of Service	0
		Units	nano-seconds
Signal	AI,11	Object Identifier	AI-11
		Object Name	Signal
		Object Type	Analog Input
		Present Value	0
		Description	Signal Amplitude
		Status Flags	F,F,F,F { }
		Event State	NORMAL
		Out Of Service	0
		Units	decibels
Quality	AI,12	Object Identifier	AI-12
		Object Name	Quality
		Object Type	Analog Input
		Present Value	0
		Description	Quality of Signal
		Status Flags	F,F,F,F { }
		Event State	NORMAL
		Out Of Service	0
		Units	percent
Noise	AI,13	Object Identifier	AI-13
		Object Name	Noise
		Object Type	Analog Input

BACnet Object Name	Obj, Instance	BACnet Object Property	Default/Sample Values
		Present Value	0
		Description	Noise Portion in Signal
		Status Flags	F,F,F,F { }
		Event State	NORMAL
		Out Of Service	0
		Units	decibels
Gain	AI,14	Object Identifier	AI-14
		Object Name	Gain
		Object Type	Analog Input
		Present Value	0
		Description	Gain at Amplifier
		Status Flags	F,F,F,F { }
		Event State	NORMAL
		Out Of Service	0
		Units	percent
Fluid Temp	AI,15	Object Identifier	AI-15
		Object Name	Fluid Temp
		Object Type	Analog Input
		Present Value	0
		Description	Temperature of the Fluid
		Status Flags	F,F,F,F { }
		Event State	NORMAL
		Out Of Service	0
		Units	°C or °F per measurement menu
Inlet Temp	AI,16	Object Identifier	AI-16

BACnet Object Name	Obj, Instance	BACnet Object Property	Default/Sample Values
		Object Name	Inlet Temp
		Object Type	Analog Input
		Present Value	0
		Description	Inlet Temperature
		Status Flags	F,F,F,F { }
		Event State	NORMAL
		Out Of Service	0
		Units	°C or °F per measurement menu
Outlet Temp	AI,17	Object Identifier	AI-17
		Object Name	Outlet Temp
		Object Type	Analog Input
		Present Value	0
		Description	Outlet Temperature
		Status Flags	F,F,F,F { }
		Event State	NORMAL
		Out Of Service	0
		Units	°C or °F per measurement menu
Fluid Pressure	AI,18	Object Identifier	AI-18
		Object Name	Fluid Pressure
		Object Type	Analog Input
		Present Value	0
		Description	Fluid Pressure
		Status Flags	F,F,F,F { }
		Event State	NORMAL
		Out Of Service	0

BACnet Object Name	Obj, Instance	BACnet Object Property	Default/Sample Values
		Units	* as selected in 207i menu
Fluid Density	AI,19	Object Identifier	AI-19
		Object Name	Fluid Density
		Object Type	Analog Input
		Present Value	0
		Description	Fluid Density
		Status Flags	F,F,F,F { }
		Event State	NORMAL
		Out Of Service	0
		Units	* as selected in 207i menu
Inlet Enthalpy	AI,20	Object Identifier	AI-20
		Object Name	Inlet Enthalpy
		Object Type	Analog Input
		Present Value	0
		Description	Inlet Enthalpy
		Status Flags	F,F,F,F { }
		Event State	NORMAL
		Out Of Service	0
		Units	kilojoules-per-kilogram
Outlet Enthalpy	AI,21	Object Identifier	AI-21
		Object Name	Outlet Enthalpy
		Object Type	Analog Input
		Present Value	0
		Description	Outlet Enthalpy
		Status Flags	F,F,F,F { }

BACnet Object Name	Obj, Instance	BACnet Object Property	Default/Sample Values
		Event State	NORMAL
		Out Of Service	0
		Units	kilojoules-per-kilogram
Error Status1	AI,22	Object Identifier	AI-22
		Object Name	Error Flag 1
		Object Type	Analog Input
		Present Value	0
		Description	Error Flag 1
		Status Flags	F,F,F,F { }
		Event State	NORMAL
		Out Of Service	0
		Units	no-units
Error Status2	AI,23	Object Identifier	AI-23
		Object Name	Error Flag 2
		Object Type	Analog Input
		Present Value	0
		Description	Error Flag 2
		Status Flags	F,F,F,F { }
		Event State	NORMAL
		Out Of Service	0
		Units	no_units
Reset Totalizers	AV-1	Object Identifier	AV-1
		Object Name	Reset Totalizers
		Object Type	Analog Value
		Present Value	0

BACnet Object Name	Obj, Instance	BACnet Object Property	Default/Sample Values
		Description	Reset Totalizers
		Status Flags	F,F,F,F { }
		Event State	0
		Out Of Service	0

4.4 Analog Input and Analog Value

4.4.1 Analog Input

The “Analog Input” from “AI,1” to “AI,21” represent values that will be displayed as a normal decimal number with a decimal point. “AI,22” and “AI,23” are 8-bit integer values. When everything is normal, both values will be zero (0). Any “Error” or “Issues,” will be displayed as bits in their respective 8-bit integer places. Example: Error Flag 1 = 8 (ultrasonic card error).

Error Status Flag 1 Decoded by Bit		
Bit	Function	Description
0 (1)	ext_fram_err	External FRAM memory error
1 (2)	ext_flash_err	External Flash memory error
2 (4)	temp_err	Internal control unit thermometer error or <-20°C or >70°C
3 (8)	usc_err	Ultrasonic card error
4 (16)	timing_err	Measurement timing error
5 (32)	io_err	IO module communication error
6 (64)	Logger	Data Logger memory remaining is <5%
7 (128)	spare	Spare

Error Status Flag 2 Decoded by Bit		
Bit	Function	Description
0 (1)	signal_amplitude_err	Received ultrasonic Signal low
1 (2)	signal_quality_err	Received ultrasonic signal Quality low
2 (4)	dropped_comm_err	Ultrasonic measurement error counter
3 (8)	spare3	Spare
4 (16)	spare4	Spare
5 (32)	spare5	Spare
6 (64)	data_logger	On when data logger memory is at 95% full
7 (128)	BACnet	SPI not communicating to BACnet

4.4.2 Analog Value

Analog Value “AV-1” can be used to reset the totalizers remotely. Just write one of the following decimal values (1, 2, or 3), and then write a 0. If you do not do this, the totalizers will keep resetting.

- 0 - Do nothing (default state)
- 1 - Reset flow totalizers.
- 2 - Reset energy totalizers.
- 3 - Reset flow and energy totalizers.

5 BACnet Engineering Units

BACnet supports a defined list of engineering units using enumerators (base 10 numbers) ranging from 1 to 255. For example, let's say your 207i is using a flow rate in ft³/min for flow units. The 207i BACnet interface will send a unit enumerator of 84 to your BACnet client. Since 84 is on the standard list of engineering units, the BACnet client will display "cubic-feet-per-minute." When at all possible, we have tried to use standard BACnet engineering units.

Proprietary BACnet engineering units are custom engineering units which the manufacturer (Sierra Instruments) defines that have an enumerator greater than 255. These custom unit enumerators may not be automatically translated into English, so your BACnet client may just display a number greater than 255. You will need to look that number up on the Sierra Custom Units Matrix below. Your BACnet client may have a way for you to add these custom units manually.

5.1 Units Not Supported By BACnet

BACnet does not support absolute and gauge pressure, so we have decided to assume gauge pressure. For example, "psig" will be displayed as "pounds-force-per-square-inch" and "psia" will use the custom enumerator of 387. BACnet does not support standardized volume units like standard-cubic-feet-per-minute and normal-cubicmeters-per-minute. These will use the Sierra Custom Units shown below.

Sierra Custom Unit Matrix			
Enumerator	Custom BACnet Unit Name	Enumerator	Custom BACnet Unit Name
338	us_gallons_per_second	455	megajoules_per_hour
339	us_gallons_per_day	456	megajoules_per_day
341	million_us_gallons_per_second	457	kilojoules_per_second
342	million_us_gallons_per_minute	458	kilojoules_per_minute
343	million_us_gallons_per_hour	459	kilojoules_per_hour
344	million_us_gallons_per_day	460	kilojoules_per_day
346	imperial_gallons_per_second	461	kilocalorie
347	imperial_gallons_per_hour	462	kilocalorie_per_second
348	imperial_gallons_per_day	463	kilocalorie_per_minute
350	usa_barrels_per_second	464	kilocalorie_per_hour
351	usa_barrels_per_minute	465	kilocalorie_per_day
352	usa_barrels_per_hour	466	btu_per_second
353	usa_barrels_per_day	467	btu_per_minute

Enumerator	Custom BACnet Unit Name	Enumerator	Custom BACnet Unit Name
355	liters_per_day	468	btu_per_hour
362	cubic_meters_per_day	469	btu_per_day
364	cubic_feet_per_day	470	million_btu
420	million_gallons	471	million_btu_per_second
420	pounds_per_cubic_foot	472	million_btu_per_minute
421	usa_barrels	473	million_btu_per_hour
427	pounds_per_square_inch_absolute	474	million_btu_per_day
428	bar_absolute	475	metric_tonnes
438	imperial_barrels	476	metric_tonnes_per_second
439	imperial_barrels_per_second	477	metric_tonnes_per_minute
440	imperial_barrels_per_minute	478	metric_tonnes_per_hour
441	imperial_barrels_per_hour	479	metric_tonnes_per_day
442	imperial_barrels_per_day	480	tons_refrigeration_per_second
443	oil_barrels	481	tons_refrigeration_per_minute
444	oil_barrels_per_second	482	tons_refrigeration_per_hour
445	oil_barrels_per_minute	483	tons_refrigeration_per_day
446	oil_barrels_per_hour	484	megapascals_absolute
447	oil_barrels_per_day	485	nanoseconds
448	gigajoules	486	kilograms_per_liter
449	gigajoules_per_second	487	kilowatt_hours_per_second
450	gigajoules_per_minute	488	kilowatt_hours_per_minute
451	gigajoules_per_hour	489	kilowatt_hours_per_hour
452	gigajoules_per_day	490	kilowatt_hours_per_day
453	megajoules_per_second	491	megapascals_gauge
454	megajoules_per_minute	1000	error

6 Troubleshooting Tips

The BACnet board has one dual LED that helps during troubleshooting. The “RX” and “TX” markings are not relevant for BACnet (See Figure 7).

1. A red LED (solid or blinking) indicates the BACnet board is not talking to the 207i Main board. This could just be caused by not configuring the BACnet board in the “Input/Output” menu, or the 207i is in a Menu and not in “RUN” mode.
2. A green LED indicates the 207i is communicating between the main board and the BACnet board. Once the 207i data starts updating, the LED will blink green at about 1 Hz. Note: This doesn’t mean the BACnet board is communicating with a BACnet network.

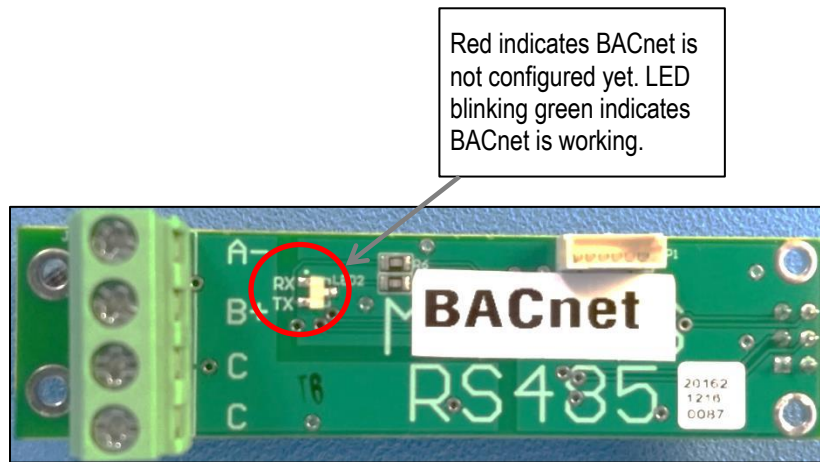

Figure 7. BACnet Module with LED light for Troubleshooting

6.1 Other Troubleshooting Tips

1. Verify polarity on the communication cable. RS-485 achieves binary transmission by switching the voltage polarity between “A-“ and “B+.” The differential voltage should be between 7V and 1.5V, while the bus is actively communicating. Sierra verifies the 207i is correct per the EIA RS-485 spec.

	CAUTION We have found cases where other devices with “A” and “B” reversed and sometimes marked as “A+” and “B-.” If in doubt, swap “A” and “B.”
--	--

2. Ensure that all devices have a unique MAC address and Device Instance.
3. Ensure that all software device instances are unique on the whole network.
4. Validate that the baud rate and parity is the same for all devices including repeaters (if used).
5. Make sure there are no more than two EOL terminations resistors present on the same segment. No intermediate device should have an EOL resistor.
6. If you are having trouble, try removing other devices on the bus temporarily.
7. In order to help narrow down a communication issue, divide the network in half and verify if the devices come online. Repeat the operation until the network is functional.
8. Swap a working and a non-working device. If the problem moved with the device, then it indicates a configuration issue or problematic device. If the problem stays at the same location, then it indicates a wiring issue.