



InnovaSonic® 210

# InnovaSonic® Model 210

## Instruction Manual

Version IM-210, Rev. 0, February 2023



**SIERRA®**

## **GLOBAL SUPPORT LOCATIONS: WE ARE HERE TO HELP!**

### **CORPORATE HEADQUARTERS**

5 Harris Court, Building L  
Monterey, CA 93940

Phone (831) 373-0200 (800) 866-0200

Fax (831) 373-4402

[www.sierrainstruments.com](http://www.sierrainstruments.com)

### **EUROPE HEADQUARTERS**

Bijlmansweid 2 1934RE  
Egmond aan den Hoef The Netherlands  
Phone +31 72 5071400  
Fax +31 72 5071401

### **ASIA HEADQUARTERS**

Second Floor Building 5, Shenpu Industrial Park  
25 Handu Road Hangtou Town  
Pu Dong New District, Shanghai, P.R. China Postal Code 201316  
Phone: + 8621 5879 8521 Fax: +8621 5879 8586

### **IMPORTANT CUSTOMER NOTICE: OXYGEN SERVICE**

Sierra Instruments, Inc. is not liable for any damage or personal injury, whatsoever, resulting from the use of Sierra Instruments standard mass flow meters or controllers for oxygen gas. You are responsible for determining if this mass flow meter or controller is appropriate for your oxygen application. You are responsible for cleaning the mass flow meter or controller to the degree required for your oxygen flow application.

### **© COPYRIGHT SIERRA INSTRUMENTS 2023**

No part of this publication may be copied or distributed, transmitted, transcribed, stored in a retrieval system, or translated into any human or computer language, in any form or by any means, electronic, mechanical, manual, or otherwise, or disclosed to third parties without the express written permission of Sierra Instruments. The information contained in this manual is subject to change without notice.

### **TRADEMARKS**

InnovaSonic® is a Registered Trademark of Sierra Instruments, Inc. Other product and company names listed in this manual are trademarks or trade names of their respective manufacturers.

## NOTICE

Thank you for choosing the 210 Ultrasonic Flow meter with SLSI CMOS and low-voltage wide-pulse transmission technology.

This instruction manual contains important information. Please read carefully before operating the flow meter.

## WARNINGS IN THIS MANUAL

Caution and warning statements are used throughout this manual to draw your attention to important information.



### WARNING

“Warning” statement appears with information that is important to protect people and equipment from harm or damage. Pay very close attention to all warnings that apply to your application. Failure to comply with these instructions may damage the meter.



### CAUTION

Failure to comply with these instructions may result in faulty operation.



### NOTE

“Note” indicates that ignoring the relevant requirements or precautions may result in flow meter damage or malfunction.

# Product Components

An inspection should be made of the desired location before installing the flow meter. Check to see if the parts are present in accordance with the packing list. Make sure that there is no shipping damage. If you have any questions, please contact your representative as soon as possible.



# Table of Contents

1.	ELECTRONICS INSTALLATION AND CONNECTION .....	7
1.1.	POWER SUPPLY CONNECTIONS .....	7
1.1.1.	<i>Type of Power Supply</i> .....	7
1.1.2.	<i>Wiring</i> .....	7
1.1.3.	<i>Data Output Wiring</i> .....	8
1.2.	POWERING ON .....	8
1.3.	KEYPAD FUNCTIONS .....	8
1.4.	KEYPAD OPERATION .....	9
1.5.	FLOW METER MENU DESCRIPTIONS .....	10
2.	SETUP AND DISPLAY SHORTCUTS .....	11
2.1.	QUICK DISPLAY KEYS .....	11
PRESS	 TO GRAPH FLOW RATE AND FLOW .....	12
2.2.	QUICK SET UP KEYS .....	12
2.3.	ILLUSTRATIONS .....	15
3.	MEASUREMENT SITE SELECTION .....	18
4.	TRANSDUCER INSTALLATION .....	19
4.1.	INSTALLING THE TRANSDUCERS .....	19
4.1.1.	<i>Transducer Mounting Methods</i> .....	19
4.1.2.	<i>V Method</i> .....	19
4.1.3.	<i>Z Method</i> .....	20
4.1.4.	<i>N Method (not commonly used)</i> .....	20
4.2.	MOUNTING THE TRANSDUCERS .....	20
4.3.	TRANSDUCER MOUNTING INSPECTION .....	21
4.3.1	<i>Signal Strength</i> .....	21
4.3.2	<i>Signal Quality (Q value)</i> .....	21
4.3.3	<i>Total Time and Delta Time</i> .....	21
4.3.4	<i>Transit Time Ratio</i> .....	21
4.3.5	<i>Warnings</i> .....	22
5.	OPERATING INSTRUCTIONS .....	23
5.1.	SYSTEM NORMAL IDENTIFICATION .....	23
5.2.	LOW FLOW CUTOFF VALUE .....	23
5.3.	ZERO SETTING .....	23
5.4.	SCALE FACTOR .....	23
5.5.	4-20MA CURRENT LOOP OUTPUT .....	24

5.6.	4-20MA CURRENT LOOP CALIBRATION .....	24
5.7.	SD CARD OPERATION .....	25
5.7.1.	<i>Specifications</i> .....	25
5.7.2.	<i>Install or Remove the SD Card While the Meter is Powered On</i> .....	25
5.7.3.	<i>Reading the SD Data Externally</i> .....	26
5.7.4	<i>SD Card Storage Operation</i> .....	26
5.8.	ESN .....	27
6.	WINDOW DISPLAY EXPLANATIONS .....	28
6.1.	WINDOW DISPLAY CODES .....	28
6.2.	DISPLAY EXPLANATION .....	44
7.	ERROR DIAGNOSTICS .....	60
7.1.	TABLE 1. SELF-DIAGNOSIS AND ERROR SOLUTIONS (UPON POWER ON) .....	60
7.2.	TABLE 2. ERROR CODES AND SOLUTIONS (DURING OPERATION) .....	61
7.3.	FREQUENTLY ASKED QUESTIONS AND ANSWERS .....	62
8.	PRODUCT OVERVIEW .....	63
8.1	INTRODUCTION .....	63
8.2	FEATURES OF FLOW METER .....	63
8.3	THEORY OF OPERATION .....	63
8.4.	APPLICATIONS .....	49
8.5.	SPECIFICATIONS .....	50
9.	APPENDIX1 - FLOW APPLICATION DATA.....	53
9.1	SOUND VELOCITY AND VISCOSITY FOR FLUIDS COMMONLY USED .....	53
9.2	SOUND VELOCITY FOR VARIOUS MATERIALS COMMONLY USE .....	54
9.3	SOUND VELOCITY IN WATER (1 ATM) AT DIFFERENT TEMPERATURES.....	55
9.4	COMMON PIPE DIMENSIONS (ENGLISH).....	56
9.5	COMMON PIPE DIMENSIONS (DIN).....	62
10.	APPENDIX 2 - WARRANTY POLICY.....	66
10.1	LIMITED WARRANTY POLICY- REGISTER ONLINE.....	66

# 1. Electronics Installation and Connection

## 1.1. Power Supply Connections

### 1.1.1. Type of Power Supply

The meter has a rechargeable 11.1V Lithium battery and matching battery charger.

### 1.1.2. Wiring

Open the hinged top cover of the electronics. The wiring ports of the 210, from left to right are as follows:

Downstream transducer connector, upstream transducer connector, SD card slot, power switch, temperature sensor connector (not used), Data output connector, and battery recharge connector.

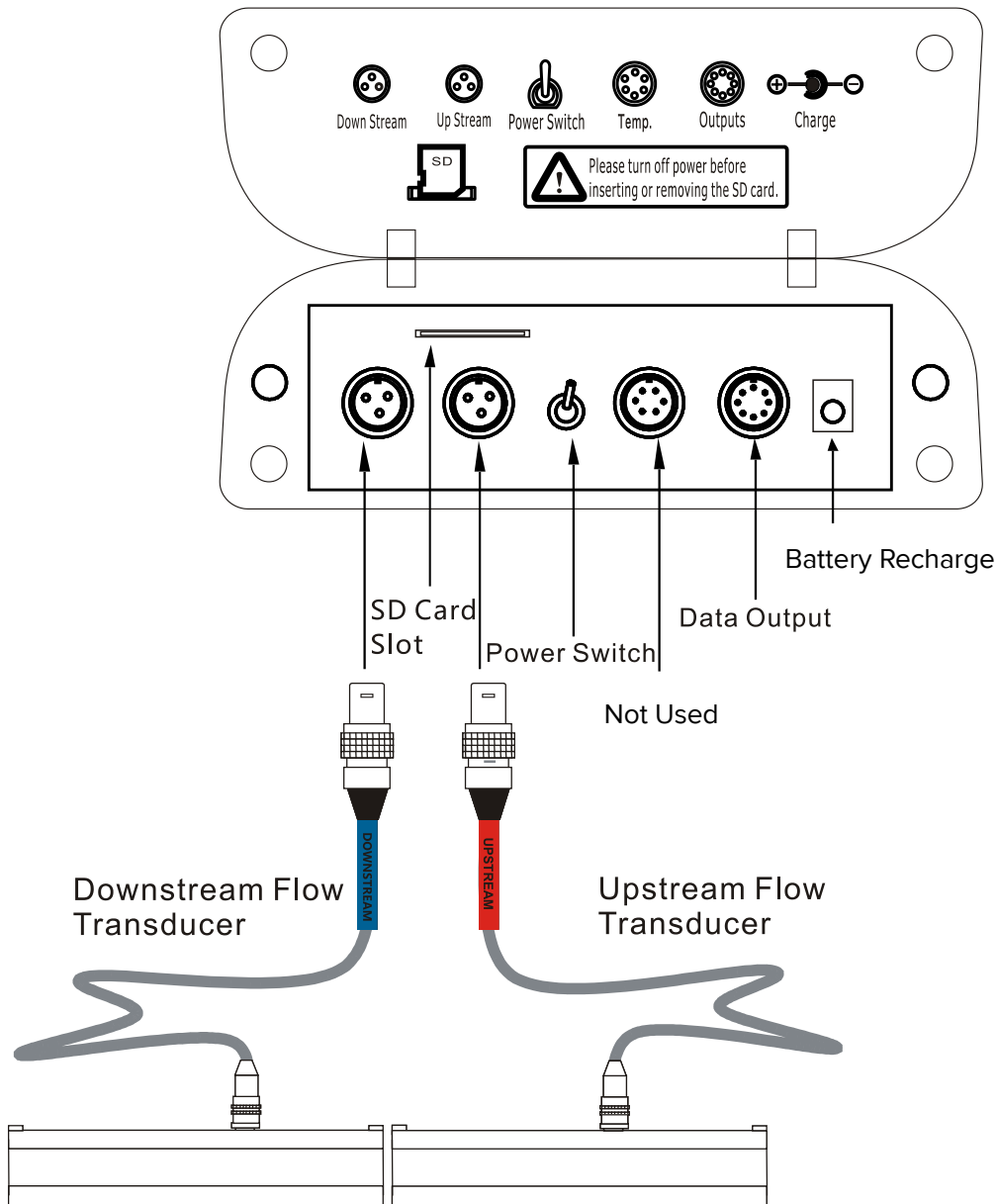



## WARNING

Wiring connections should be made when power is off.

### 1.1.3. Data Output Wiring

Data output wiring as shown below: Connect the data output breakout box cable 8-pin plug to the data output connector on the 210. The breakout box provides Modbus RS-485 A & B, 4-20 mA (I+ & I-), Relay (RL1 & RL2), and OCT+ and OCT-. Connect to the terminals as needed.

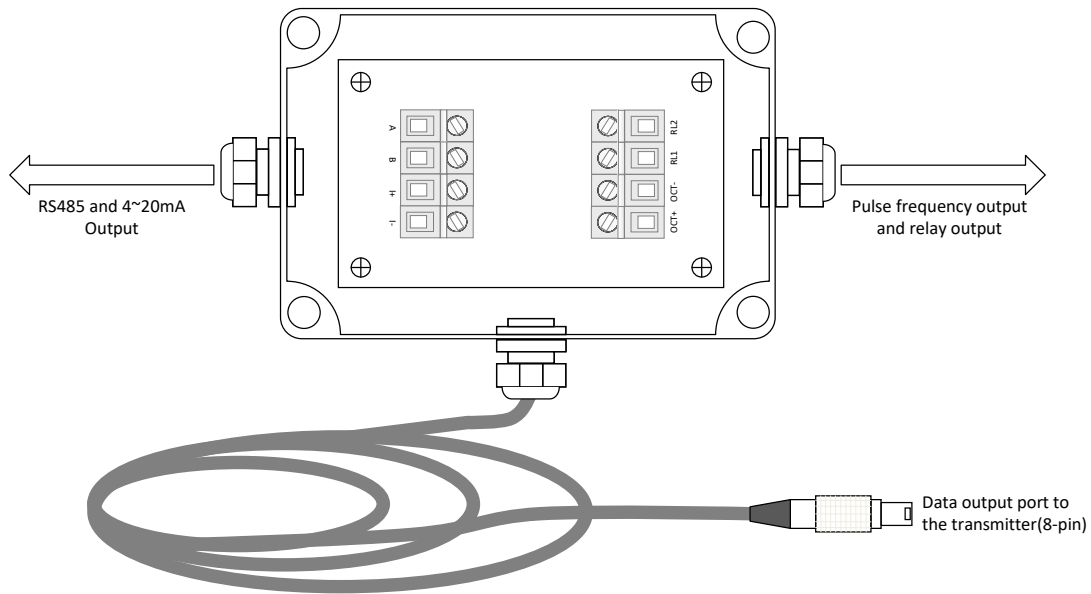

## 1.2. Powering On

As soon as the flow meter is switched on, the self-diagnostics program will start to run. If any error is detected, an error code will be displayed on the screen (see Error Diagnostics). After that, the system will run automatically using the programmed parameters.

All the parameters put in by the user will be saved permanently until they are changed by the user.

## 1.3. Keypad Functions

The InnovaSonic 210 keypad offers 12 dual-function keys for operation of the menu system plus six quick-setup keys. For quick setup of your InnovaSonic, simply press any of the keys across the top to get the desired menu instantly.



Follow these guidelines when using the flow meter keypad:

- and to input numbers.

Backspace or delete characters to the left.

Return to the last menu or open the next menu. Acts as "+" and "-" when used to enter numbers.

Select a menu. Press this key first, input a two-digit menu number and the selected menu data will be displayed. For example, to input a pipe outside diameter, press where "11" is the window ID to display the pipe outside diameter.

Enter / confirm to complete the input.

Enter / exit SD card storage interface.

are shortcuts to the windows for Flow Rate, Velocity, Signal Quality, POS Totalizer, graphing, and Diagnosis.

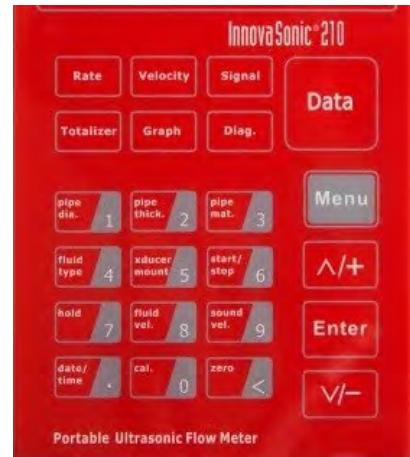

## 1.4. Keypad Operation

The instrument setup and measurement displays are subdivided into more than 100 independent menus. The operator can input parameters, modify settings or display measurement results by “visiting” a specific menu. These menus are arranged by 2-digit serial numbers from 00~99, then onward using +0, +1, etc. Each menu ID code has a defined meaning. For example, menu 11 is the pipe outside diameter, while menu 25 is the mounting spacing between the transducers. Each menu is discussed later in this manual.

To enter a specific menu, press the key at any time (except while using the SD Card Storage Interface), then input the 2-digit menu ID code and that menu will be displayed. For example, to input or check the pipe outside diameter, press the keys for window ID code 11.

Another method to enter a particular menu is to press the and keys to scroll through the menus. For example, if the current menu is 30, press key to enter menu 31, press the button again to enter menu 30.

The menus are divided into three types:

- 1) Data Type (type numbers as required), such as M11, M12;
- 2) Selection Type (select from list), such as M14;
- 3) Display Type, such as M00, M01.

To enter Data Type menus to check specific parameters. If you need to change a parameter, just input the values then press ; or press first, then input the values and press to confirm.

**Example 1:** To enter a pipe outer diameter of 168mm, the procedure is as follows:

Press to enter Menu11 (the numerical value currently displayed is the previous pipe outer diameter). Now press the key. The symbol ">" and a flashing cursor is displayed on the left side of the third line on the screen. The new value can now be entered. .

Visit Selection Type menus to check the related options. If you need to modify them, press then enter the revised selection when the symbol ">" and a flashing cursor are displayed at the left end of the third line on the screen; or input numbers directly to select the option when the symbol ">" and a flashing cursor are displayed.

**Example 2:** If the pipe material is "Stainless Steel", press to enter Menu 14, and then press to modify the option. Then, select "1. Stainless Steel" from the drop-down menu (you may cycle through the choices by pressing the and keys) and then press to confirm the selection. It is also possible to press the key to change the selection and wait until "1. Stainless Steel" is displayed on the second line of the screen. Then press the key to confirm.



## 1.5. Flow Meter Menu Descriptions

- 00-09 Display menus: Used to display flow rate, positive total, negative total, net total, velocity, date & time
- 10-29 Setup menus: Used to enter pipe outer diameter, pipe wall thickness, fluid type, transducer type, transducer mounting and spacing
- 30-38 Flow units selection and totalizer operating menus: Used to select units of measurement. Other menus set/reset the various totalizer modes.
- 40-45 Zero Set Calibration, Scale Factor.
- 55-83 Input and output setup menus: current loop mode select, 4mA or 0mA output value
- 90-94 Diagnostics: signal strength quality (Menu 90), TOM/TOS\*100 (Menu 91), sound velocity (Menu 92), total time and delta time of the measured signal (Menu 93), Reynolds number and K factor (Menu 94).
- +0-/ +4 Appendix: Power on/off time, total working hours, on/off times
- 0 4~20mA correction menu.



### CAUTION

"Hidden" menus are for hardware adjustment (set by the manufacturer).

## 2. Setup and Display Shortcuts

### 2.1. Quick Display Keys

Press  to display Flow Rate with large font.

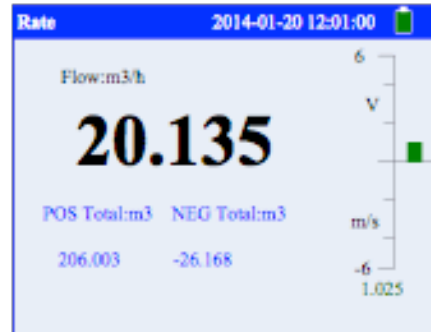

Press  to display Velocity with large font.



Press  to display Signal Quality with large font.



Press  to display POS Total with large font).





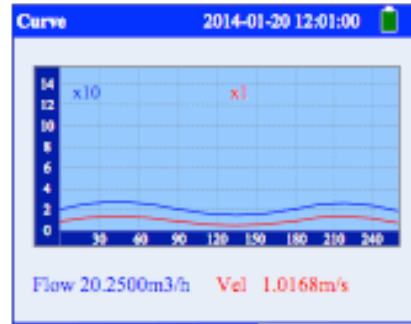

Press  to graph Flow Rate and Flow Velocity







Press  to display the Current State of the System.



## 2.2. Quick Set up Keys

Press  to display Pipe Outside Diameter. The function is the same as   . Press enter to input data, then enter again to save data.



Press  to display Pipe Wall Thickness. The function is the same as   . Press enter to input data, then enter again to save data.



Press **pipe mat. 3** to display Pipe Material. The function is the same as **Menu pipe dia. 1 pipe mat. 3**. Press enter to input data, then press enter again to save data.



Press **xducer type 5** to display Transducer Mounting Methods. The function is the same as **Menu pipe dia. 1 xducer type 5**. Press enter to input data, then press enter again to save data.



Press **start/stop 6** to Start / Stop Manual Totalizer



Press **hold 7** to Display / Hold flow totalizer in turn. The totalizer will continue to run in the background if hold is pressed. This function allows you to quickly write down or show the totalized value to another.



Press **fluid vel. 8** to display Dynamic / Normal Flow Rate and Flow Velocity.

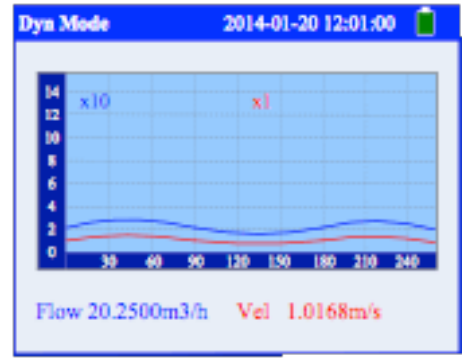

Press **sound vel. 9** to display Fluid Sound Velocity. The function is the same as **Menu 9 2**.

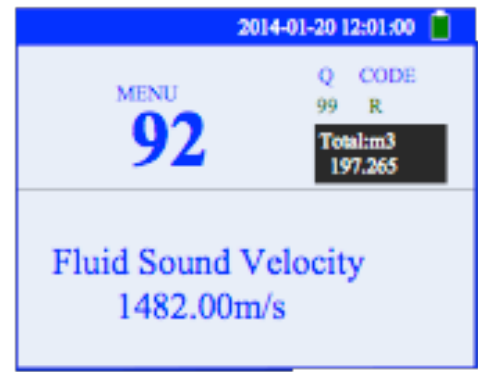

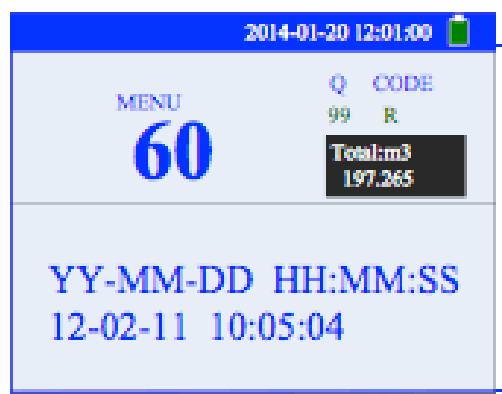

Press **date/time** to display Date and Time. The function is the same as **Menu 6 0**.

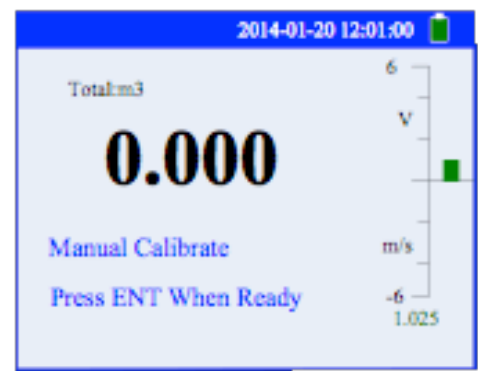

Press **cal. 0** to enter Manual Calibrate.

- Under constant velocity conditions:
1. Using a flow standard, externally totalize the flow for a set time period.
  2. Press cal, then press enter to start the totalizer.
  3. Totalize for the same time period as in step 1, then press enter to stop the totalizer.
  4. Press enter again, then enter the totalized flow from step 1.
  5. The 210 will compare the two values and calculate a K factor.







Press  to input the password 1234 to reset zero.



## 2.3. Illustrations





For Example: Let us assume you have a DN150 (6") pipe. The measuring medium is water and material is carbon steel with no liner. These parameters should be operated as follows:

### Step 1. Pipe Outer Diameter

Press    keys to enter Menu 11, enter the Pipe Outside Diameter, then press the  key. Press enter to input data, then press enter again to save data.









### Step 2. Pipe Wall Thickness

Press the    key to enter Menu 12 enter the Pipe Wall Thickness (wall thickness for various pipe schedules can be found in the appendix), then press the  key. Press enter to input data, then press enter again to save data. Note: Decimal values must be entered with a leading zero. Example: 0.375 inches



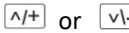





### Step 3. Pipe Material

Press the    key to enter Menu 14, press the  key, use the  key to select the pipe material from the drop-down menu, then press the  key.









#### Step 4. Liner Material Parameters

(including thickness and sound velocity, if needed):

Press the    key to enter Menu 16, press the  key, use the  or  key to select liner material from the drop-down menu, and then press the  key.







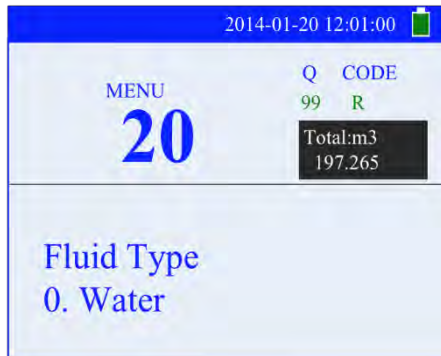

#### Step 5. Fluid Type

Press the    key to enter Menu 20, press the  key, use the  or  key to select fluid type from the drop-down menu, then press the  key.









#### Step 6. Transducer Mounting

Press the    key to enter Menu 24, press The  key, use the  or  key to select Transducer mounting from the drop-down menu, then press the  key.  
(Details on Chapter 3.1.1).





#### Step 6. Transducer Mounting

Press the    key to enter Menu 24, press The  key, use the  or  key to select Transducer mounting from the drop-down menu, then press the  key.  
(Details on Chapter 3.1.1).





### Step 7. Transducer Spacing

Press the    key to enter Menu 25, accurately install the transducer according to the displayed transducer mounting spacing and the selected mounting method. (Details on Chapter 2.3).

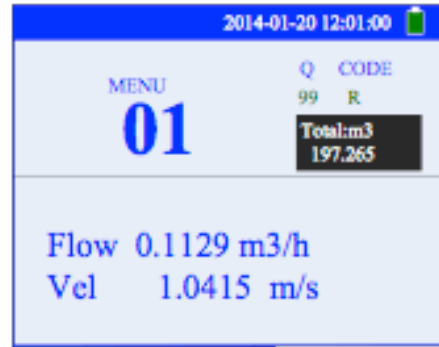

### 3. Measurement Site Selection

When selecting a measurement site, it is important to select an area where the fluid flow profile is fully developed to guarantee a highly accurate measurement. Use the following guidelines to select a proper installation site:

1. Choose a section of pipe that is always full of liquid, such as a vertical pipe with flow in the upward direction or a full horizontal pipe.
2. Ensure enough straight pipe length at least equal to the figure shown below for the upstream and downstream transducers installation.
3. On the horizontal pipe, the transducer should be mounted on the 3 o'clock and 9 o'clock position of the pipe section, avoid the 6 o'clock and 12 o'clock position, in order to avoid the signal attenuation caused by the sediment at the bottom, or air bubbles or cavitation.
4. Consider the inside condition of the pipe carefully. If possible, select a section of pipe where the inside is free of excessive corrosion or scaling.

Name	Straight length of upstream piping	Straight length of downstream piping
90° bend		
Tee		
Diffuser		
Reduce		
Valve		
Pump		

# 4. Transducer Installation

## 4.1. Installing the Transducers

Before installing the transducers, clean the pipe surface where the transducers are to be mounted. Remove any rust, scale or loose paint and make a smooth surface. Apply a wide band of sonic coupling compound down the center of the face of each transducer as well as on the pipe surface, and then attach the transducers to the pipe with the straps provided and tighten them securely.

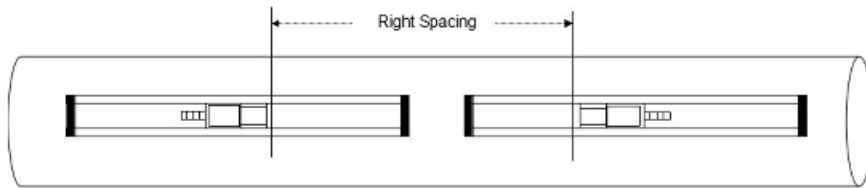

**Note:**

1. The two transducers should be mounted at the pipe’s centerline on horizontal pipes. Make sure that the transducer mounting direction is parallel with the flow.
2. During the installation, there should be no air bubbles or particles between the transducer and the pipe wall. On horizontal pipes, the transducers should be mounted in the 3 o’clock and 9 o’clock positions of the pipe section in order to avoid any air bubbles inside the top portion of the pipe.
3. Refer to Transducer Mounting on Menu 25.
4. If the transducers cannot be mounted horizontally symmetrically due to limitations of the local installation conditions, it may be necessary to mount the transducers at a location where there is a guaranteed full pipe condition (the pipe is always full of liquid).

### 4.1.1. Transducer Mounting Methods

Three transducer mounting methods are available. They are respectively: V method, Z method and N method. The V method is primarily used on small diameter pipes (DN100~300mm, 4”~12”). The Z method is used in applications where the V method cannot work due to poor signal or no signal detected. In addition, the Z method generally works better on larger diameter pipes (over DN300mm, 12”) or cast iron pipes.

The N method is an uncommonly used method. It is used on smaller diameter pipes (below DN50mm, 2”).

### 4.1.2. V Method

The V method is considered as the standard method. It usually gives a more accurate reading and is used on pipe diameters ranging from 50mm to 400mm (2”~16”) Also, it is convenient to use, but still requires proper installation of the transducer, contact on the pipe at the pipe’s centerline and equal spacing on either side of the centerline.

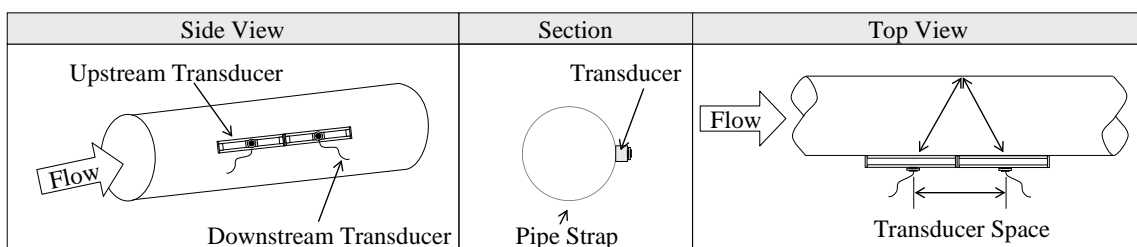

### 4.1.3. Z Method

The signal transmitted in a Z method installation has less attenuation than a signal transmitted with the V method. This is because the Z method utilizes a directly transmitted (rather than reflected) signal which transverses the liquid only once.

The Z method is able to measure on pipe diameters ranging from 25mm to 1200mm (1"~48").

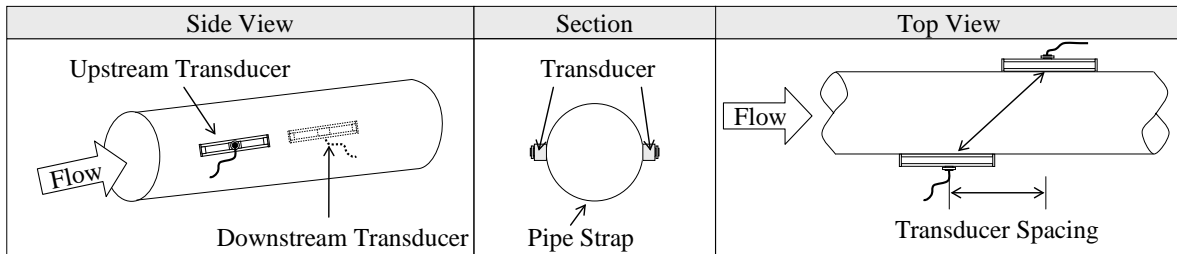

### 4.1.4. N Method (not commonly used)

With the N method, the sound waves traverse the fluid twice and bounce three times off the pipe walls. It is suitable for small pipe diameter measurement.

The measurement accuracy can be improved by extending the transit distance with the N method (uncommonly used).

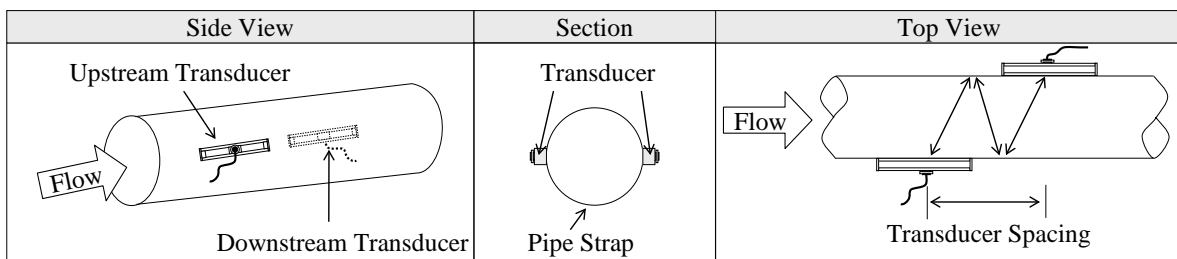

## 4.2. Mounting the Transducers

Transducers can stick onto the pipe with magnetic steel racks. If you need to fasten them more securely, then you can use the hose clamps or even zip ties ... See picture below.

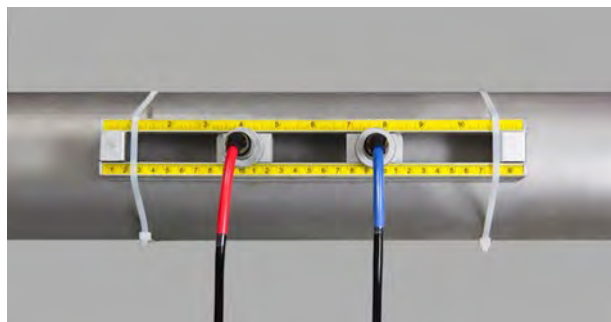

## 4.3. Transducer Mounting Inspection

Check to see if the transducer is installed properly and if there is an accurate and strong enough ultrasonic signal to ensure proper operation and high reliability of the transducer. It can be confirmed by checking the detected signal strength, total transit time, delta time as well as transit time ratio. These checks are explained below.

The “mounting” condition directly influences the flow value accuracy and system reliability. In most instances, apply a wide bead of sonic coupling compound lengthwise on the face of the transducer and stick it to the outside pipe wall to get good measurement results. However, the following inspections still need to be carried out in order to ensure high reliability of the measurement and long-term operation of the instrument.

### 4.3.1 Signal Strength

Signal strength (displayed in Menu 90) indicates the detected strength of the signal both from upstream and downstream directions. The relevant signal strength is indicated by numbers from 00.0~99.9. 00.0 represents no signal detected while 99.9 represent maximum signal strength.

Normally, the stronger the signal strength detected, the better the measurement. Adjust the transducer spacing to the best position and check to ensure that enough sonic coupling compound is applied during installation in order to obtain the maximum signal strength. This is essentially fine tuning the calculated spacing shown in Menu 25 (transducer spacing). It may be slightly different.

System normal operation requires signal strength over 60.0, which is detected from both upstream and downstream directions. If the signal strength detected is too low, the transducer installation position and the transducer mounting spacing should be re-adjusted and the pipe should be re-inspected. If necessary, change the mounting to the Z method (Z has the highest signal strength).

### 4.3.2 Signal Quality (Q value)

Q value is short for Signal Quality (displayed in Menu 90). It indicates the level of the signal detected. Q value is indicated by numbers from 00~99. 00 represents the minimum signal detected while 99 represent the maximum.

The transducer position should be adjusted and enough coupling used to get the signal quality detected as strong as possible.

### 4.3.3 Total Time and Delta Time

“Total Time and Delta Time” are displayed in Menu 93. The measurement calculations in the flow meter are based upon these two parameters. Therefore, when “Delta Time” fluctuates widely, the flow and velocities fluctuate accordingly. This means that the signal quality detected is poor. It may be the result of poor pipe-installation conditions, inadequate transducer installation or incorrect parameter input.

Generally, “Delta Time” fluctuation should be less than  $\pm 20\%$ . Only when the pipe diameter is too small or velocity is too low can the fluctuation be wider.

### 4.3.4 Transit Time Ratio

Transit Time Ratio indicates if the transducer mounting spacing is accurate. The normal transit time ratio should be  $100 \pm 3$  if the installation is proper. Check Menu 91. This is an important value and must be within the limits before the strength and quality will be meaningful. To bring this value into this window of  $\pm 0.3\%$ , move one of the transducers in or out.

## CAUTION

If the transit time ratio is over  $100\pm 3$ , it is necessary to check:





- 1) If the parameters (pipe outside diameter, wall thickness, pipe material, liner, etc.) have been entered correctly,
- 2) If the transducer mounting spacing is in accordance with the display in Menu 25,
- 3) If the transducer is mounted at the pipe's centerline on the same diameter,
- 4) If the scale buildup is too thick or the pipe mounting is distorted in shape,
- 5) If the correct fluid or sound velocity was entered

### 4.3.5 Warnings

1. Pipe parameters entered must be accurate; otherwise the flow meter will not work properly.
2. The wrong fluid or fluid sound velocity can also cause inaccurate readings.
3. During the installation, apply enough coupling compound to bond the transducer onto the pipe wall. While checking the signal strength and Q value, move the transducer slowly around the mounting site until the strongest signal and maximum Q value are obtained. The larger the pipe diameter, the more the transducer may have to be moved.
4. Check to be sure the mounting spacing is as calculated in Menu 25 and the transducer is mounted at the pipe's centerline on the same diameter. Note that you can adjust the spacing slightly as described above to fine tune the device.
5. Pay special attention to those pipes formed by steel rolls (pipe with seams), since such pipe is always irregular. If the signal strength is always displayed as 0.00, that means there is no signal detected. Thus, it is necessary to check that the parameters (including all the pipe parameters) have been entered accurately. Check to be sure the transducer mounting method has been selected properly, the pipe does not have heavy scaling, and the liner is not too thick. Make sure there is indeed fluid in the pipe or the transducer is not very close to a valve or elbow, and/or there are not too many air bubbles in the fluid. Once you have ruled out all these possible reasons, if there is still no signal detected, the measurement site has to be changed.

# 5. Operating Instructions

## 5.1. System Normal Identification

Press the    keys. If the letter “\*R” displays on the screen, it indicates System Normal.

- If the letter “E” is displayed, it indicates that the current loop output is over ranged by 120%. This refers to the settings in Menu 57. Enter a larger value in Menu 57, and the letter “E” will disappear. It can be ignored if no current loop output is used.
- If the letter “H” is displayed, it indicates that the ultrasonic signal detected is poor. For more information, please refer to “Error Diagnosis” (see Chapter 7).
- If the letter “G” is displayed, it indicates that system is adjusting the signal gain prior to the measurement. Also, it means system normal. If the adjustment takes too long without stopping, the system can be identified as abnormal.
- Letter “I” indicates no signal is being detected. Check to see if the transducer wiring connections are correct, the transducers are securely installed, etc.
- Letter “J” indicates a hardware defect exists. Normally, such a defect is temporary; it may be eliminated by system reboot (power off and restart).

For further information, please refer to “Error Diagnosis” (see Chapter 7).

## 5.2. Low Flow Cutoff Value

The data in Menu 41 is the Low Flow Cutoff Value. If the flow rate falls below the low flow cutoff value, the flow rate is driven to zero. This function can prevent the flow meter from reading flow after a pump is shut down but there is still liquid movement in the pipe, which will result in a totalization error. Generally, 0.03m/s is recommended to enter as the low flow cutoff point. The low flow cutoff value has no relation to the measurement results once the velocity increase over the low flow cutoff value.

## 5.3. Zero Setting

Once zero flow occurs, a zero point is established, i.e. as the measurement value reaches zero flow, it indicates as zero. It is necessary to establish the true zero flow condition and program that set point into the instrument. If the zero set point is not at true zero flow, an offset will occur. For an ultrasonic Flow meter, the measurement difference from zero point cannot be ignored under low flow conditions. It is necessary to perform a zero set calibration to improve low flow measurement accuracy.

Set Zero in Menu 42, press , wait for the processing indication at the bottom right corner of the screen to reach “0”. Performing Set Zero with under flowing conditions may cause the flow to be displayed as “0”. If so, it can be recovered via Menu 43.

## 5.4. Scale Factor

Scale factor refers to the ratio between “actual value” and “reading value”. For example, when the measurement is 2.00, and it is indicated as 1.98 on the instrument, the scale factor reading is 2/1.98. This means that the best scale factor constant is 1. However, it is difficult to keep the scale factor as “1” on the instrument especially in batch control operations. The difference is called “consistency”. The scale factor default is “1” for each instrument prior to shipment from the factory. The reason is that the scale factors in the flow meter are only limited by two parameters, i.e. the crystal oscillation frequency and the transducer. It has no relation to any circuit parameters. The scale factor can be entered via Menu 45.







## 5.5. 4-20mA Current Loop Output

The 210 comes with a breakout box that plugs provides the 4~20 mA output connector on the front panel. The black wire is 4~20 mA - and the blue wire is 4~20 mA +. This is an active 4~20 mA output; do not apply an excitation voltage. The brown and white wires are unused.

The current loop output exceeds an accuracy of 0.1%, and the flow meter is programmable and configurable with outputs such as 4~20mA or 0~20mA selected in Window M55. For details, please refer to “Window Display Explanations” (see Chapter 6).

In Window M56, enter a 4mA flow value. Enter the 20mA flow value in Window M57. For example, if the flow range in a specific pipe is 0~1000m<sup>3</sup>/h, enter 0 in Window M56 and 1000 in Window M57. If the flow ranges from -1000~0~2000m<sup>3</sup>/h, configure the 20~4~20mA output by selecting Window M55 when flow direction is not an issue. Enter 1000 in Window M56 and 2000 in Window M57. When flow direction is an issue, an output of 0~4~20mA is available. When the flow direction displays as a negative value, the current output is in the range of 0~4mA, whereas the 4~20mA is for the positive direction. The output options are displayed in Window M55. Enter “-1000” in Window M56 and 2000 in Window M57.

Verification and testing the current loop is performed in Window M58. Complete the steps as follows:

Press    , move  or  to display “0mA”, “4mA”, “8mA”, “16mA”, “20mA” readings, connect an amp meter to test the current loop output and calculate the difference. Calibrate it if the difference is not within tolerance. Refer to Section 5.6 for Current Loop Verification.

Check the present current loop output in Window M59 as it changes with change in flow.





## 5.6. 4-20mA Current Loop Calibration







### NOTE

Do not perform this operation unless the actual output current value is different from the value indicated in Menu 58 CL Check Verification. Every meter has been calibrated before leaving the factory.

Calibrate the analog input requires using below procedure:

Press    , enter the password “115800”, then press . A “>4mA” prompt will appear.

Connect a milliamp meter to the 4~20mA output to measure the current. Press  or  to adjust the displayed value on your milliamp meter. Your milliamp should indicate 4.00mA. when the 4mA is adjusted properly.

Then press  to enter the Current Loop Verification Mode, press  to enter the 4mA verification status, use an accurate ammeter to measure the output current of the current loop, and

Press  to adjust the 20mA calibration using the same procedure as for the 4mA verification.

Press  to save the results in the EPROM. This calibration will be permanent when the instrument is powered off.



## 5.7. SD Card Operation

### 5.7.1. Specifications

Memory: 8 GB (Standard)

Data collection update rate: user selectable: 1 second to 60 seconds. If the rate is set longer than 60 seconds the default will be 60 seconds. Every data point is a snapshot, not an average.

Data content: date and time, flow, velocity, totalized flow, positive totalizer and negative totalizer.

Data collection time: user selectable from 1~9,999 mins (166.65 hours). If it is set is longer than 9999 mins, it will default to 9999 mins. This is the total collection time. Collection will stop at this point and the screen will prompt for the next instruction either save, or begin again and overwrite. Collection can be paused at any time, and restarted manually until the total time is complete.

Data storage format:   1=07-04-10, 14:16:33  
                          2=+3.845778E+01m3/h  
                          3=+1.451074E+00m/s  
                          4=-0000010E+0m3  
                          5=+0000002E+0m3  
                          6=-0000012E+0m3

File system format: FAT32

File type: plain text file (.txt)

The 210 now support FAT32. For that reason you are not limited to 512 files.

Filename format: yymmdd       (yy - year, mm - month, dd - day)

Turn to Section 5.7.4 for details if want to change a filename.

It can save 120 bytes of data each time. When the capacity of the SD card is full, the new data will override the earliest files automatically (it will rollover).

NOTE: The data is stored in metric units ONLY. This cannot be changed. The data can be cut and pasted into excel and manipulated (converted to other units) if required.

### 5.7.2. Install or Remove the SD Card While the Meter is Powered On

If the operator desires to insert or remove the SD card with power on, the following operation is to be used:

1. Insert or remove the SD card without data storage.
2. To save data, press  button for 4 seconds, exit the acquisition, and then insert or remove the SD card.



#### CAUTION

Do not remove the SD card from the reader while actively collecting data. Processing the data directly from the SD card file location on the PC could result in lost or corrupt data if the SD card is removed while data is still being processed.

### 5.7.3. Reading the SD Data Externally

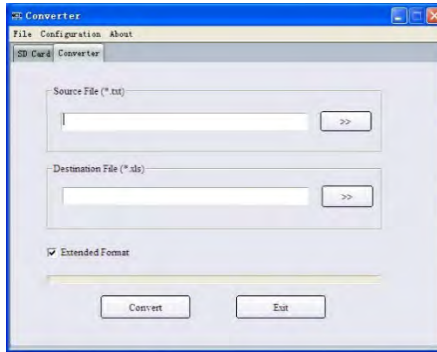

- 2 Remove the SD card from the Flow meter. The operator may then use a PC card reader to read the data on the card.
- 3 Use “Converter.exe” software to convert the format when needed. File Converter Tool (Click “offline” bottom to enter the document conversion interface)
- 4 Press “Converter” button and then convert the SD card data format from “.TXT” to “.XLS”, see below:

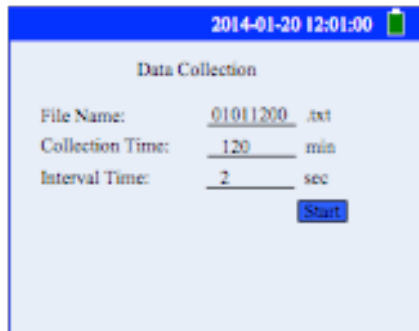

### 5.7.4 SD Card Storage Operation

1. Insert the SD card, then press data  button to enter the SD card storage setting interface.



2. If you need to modify the file name, acquisition time or acquisition interval, press enter, then enter the number to modify it, then press enter again to save. Press  or  button for line feed.

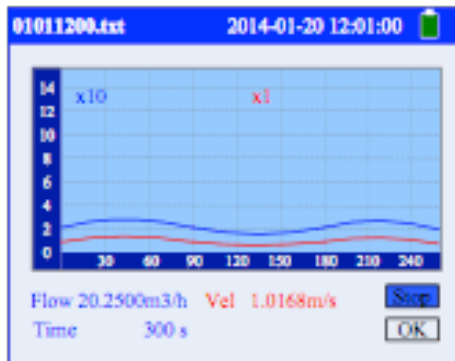

3. After modification or to use the default value, scroll to start and press  to begin the data collection. The above picture shows the normal, active data collection screen. Below is the data collection set up screen. Note: The screen will remain captive during data collection.

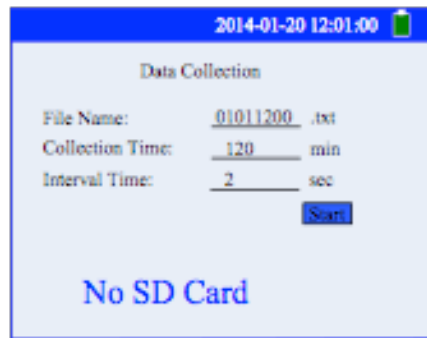

4. To pause data collection, chose "Stop," to restart, press "Start." To finish, press "Stop," then "OK."

## 5.8. ESN

We have provided the flow meter with a unique electronic serial number to identify each flow meter for the convenience of the manufacturer and customers. The ESN, instrument types and versions are shown in Window M61.

## 6. Window Display Explanations

### 6.1. Window Display Codes

Flow Totalizer Display	38 Manual Totalizer
00 Flow Rate/Net Totalizer	Setup Options
01 Flow Rate/Velocity	40 Damping
02 Flow Rate/POS Totalizer	41 Low Flow Cutoff Velocity
03 Flow Rate/NEG Totalizer	42 Set Zero
04 Date Time/Flow Rate	43 Reset Zero
05 Not Supported	44 Manual Zero Point
06 Not Supported	45 Scale Factor
07 Not Supported	Input and output setup
08 System Error Codes	46 Network IDN
09 Net Flow Today	47 System Lock
Initial Parameter setup	48 Segmented Correction
10 Pipe Outer Perimeter	49 Segment Factor
11 Pipe Outer Diameter	55 CL Mode Select
12 Pipe Wall Thickness	56 CL 4mA Output Value
13 Pipe Inner Diameter	57 CL 20mA Output Value
14 Pipe Material	58 CL Checkup
15 Pipe Sound Velocity	59 CL Current Output
16 Liner Material	60 Date and Time
17 Liner Sound Velocity	61 ESN
18 Liner Thickness	67 FO Frequency Range
20 Fluid Type	68 Low FO Flow Rate
21 Fluid Sound Velocity	69 High FO Flow Rate
22 Fluid Viscosity	72 Working Timer
24 Transducer Mounting	73 Alarm #1 Low Value
25 Transducer Spacing	74 Alarm #1 High Value
26 Parameter Setups	77 Beeper Setup
27 Cross-sectional Area	Diagnoses
28 Holding with Poor Sig	90 Signal Strength and Quality
29 Empty Pipe Setup	91 TOM/TOS*100
Flow Units Options	92 Fluid Sound Velocity
30 Measurement Units	93 Total Time and Delta
31 Flow Rate Units	94 Reynolds Number and Factor
32 Totalizer Units	96 Time Fixed Delay
33 Totalizer Multiplier	97 Language Select
35 POS Totalizer	Appendix
36 NEG Totalizer	-0 Hardware Parameter Modification
37 Totalizer Reset	-1 Not supported

NOTE: \* Temperature and Energy are not supported on the 210.

## 6.2. Display Explanation



### Flow Rate / Net Totalizer

Display flow rate and net Totalizer.

If the net Totalizer has been turned off (refer to Window M34), the net Totalizer value displayed is the total that existed prior to turning it off.

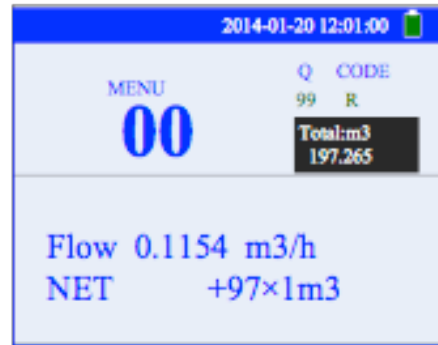

### Flow Rate / Velocity

Display flow rate and velocity.

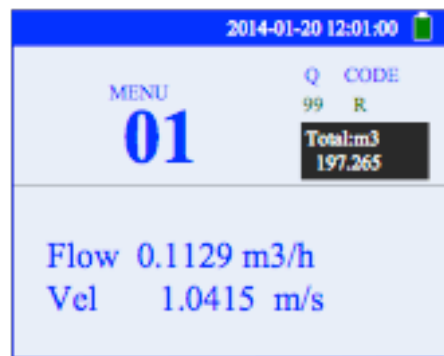

### Flow Rate / Positive Totalizer

Display flow rate and positive Totalizer.

Select the positive Totalizer units in Window M31.

If the positive Totalizer has been turned off, the positive Totalizer value displayed is the total the total that existed prior to turning it off.

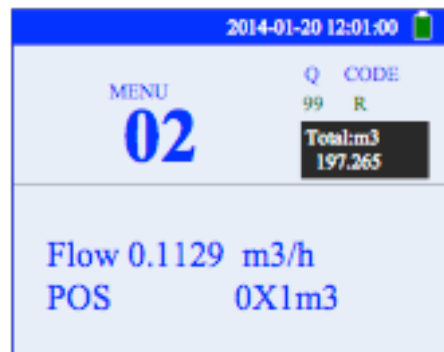

### Flow Rate / Negative Totalizer

Display flow rate and negative Totalizer.

Select the negative Totalizer value in Window M32.

If the negative Totalizer has been turned off (refer to Window M36), the value displayed is total the total that existed prior to turning it off.





### Date Time / Flow Rate

Display the current date time and flow rate.

The time setting method is found in Window M60.

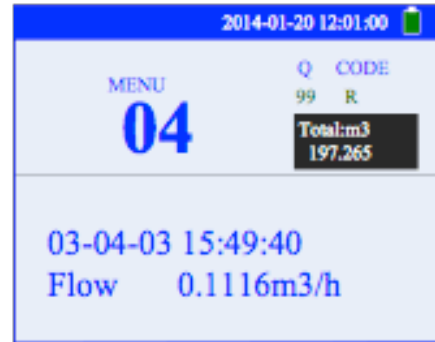

### System Error Codes

Display the operating condition and the system error codes. More than one error code can occur at the same time.

The explanations of error codes and detailed resolution methods can be found in "Error Diagnosis".

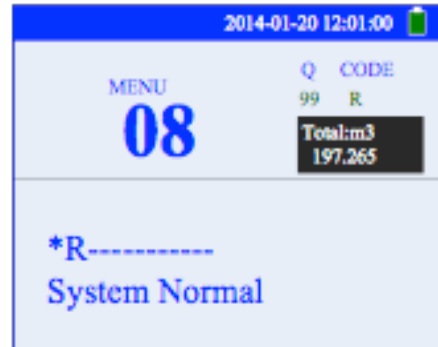

### Net Flow Today

Display net total flow today.

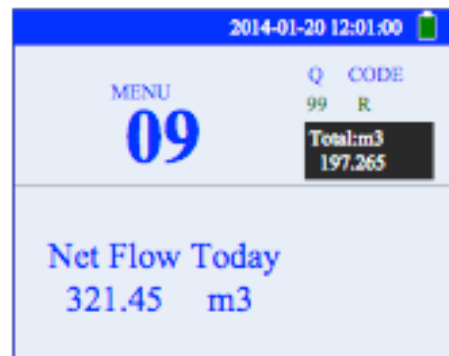

### Pipe Outer Perimeter

Enter the pipe outer perimeter (circumference). If the diameter is not known, enter it in Window M11.





### **Pipe Outside Diameter**

Enter the pipe outside diameter; the pipe outside diameter must range from 10mm to 600mm.

Note: Enter either the pipe outside diameter or pipe outer perimeter.



### **Pipe Wall Thickness**

Enter the pipe wall thickness with a leading zero. If the pipe inside diameter is already known, skip this window and enter it in Window M13. Example: 0.375 in.



### **Pipe Inner Diameter**

Enter the pipe inside diameter. If the pipe outside diameter and pipe wall thickness has been entered, press  to skip this window.

Note: Enter either pipe wall thickness or pipe inside diameter.



### **Pipe Material**

Enter pipe material. The following options are available (by 、 buttons or numerical keys):

- |                    |                      |
|--------------------|----------------------|
| 0. Carbon Steel    | 6. Aluminum          |
| 1. Stainless Steel | 7. Asbestos          |
| 2. Cast Iron       | 8.                   |
| 3. Ductile Iron    | 9. Fiber Glass-Epoxy |
| 4. Copper          | 10.                  |
| 5. PVC             | 11. Other            |



Refer to item 9 “Other”; it is possible to enter other materials, which are not included in previous eight items. Once item 9 is selected, the relevant pipe sound velocity must be entered in Window M15. If sound velocity is not known, there are other ways to determine it onsite.



### **Pipe Sound Velocity**

Enter pipe sound velocity. This function is only used when item 9 “Other” is selected in Window M14. Unless other is selected as above, this window cannot be changed but will be calculated automatically according to the existing parameters.



### **Select the Liner Material**

The following options are available:

0. None, No Liner
1. Tar Epoxy
2. Rubber
3. Mortar
4. Polypropylene
5. Polystyryol
6. Ploystyrene
7. Polyester
8. Polyethylene
9. Ebonite
10. Teflon
11. Other

Item 11 “Other” is available to enter other materials that are not included in previous ten items. Once the “Other” is selected, the relevant liner sound velocity must be entered in Window M17.



### **Liner Sound Velocity**

Enter liner sound velocity. It only can be visited when item “Other” in Window M16 is selected.







### Liner Thickness

Enter liner thickness. It only can be visited when a liner is selected in Window M16



### Select Fluid Type

The following options are available:

0. Water
1. Sea Water
2. Kerosene
3. Gasoline
4. Fuel Oil
5. Crude Oil
6. Propane
7. Butane (0°C)
8. Other
9. Diesel Oil
10. Castor Oil
11. Peanut Oil
12. Gasoline #90
13. Gasoline #93
14. Alcohol
15. Water (125°C)

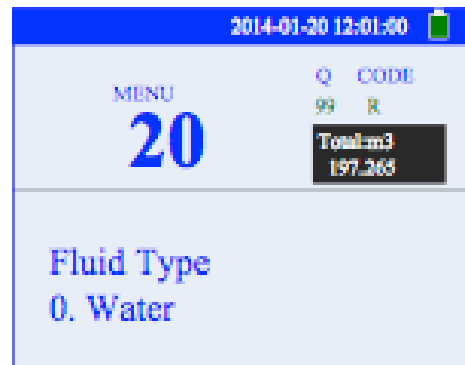

### Fluid Sound Velocity

Enter the fluid sound velocity. It only can be used when item "Other" is selected in Window M20, i.e. it is unnecessary to enter all the fluids listed in Window M20.





### Fluid Viscosity

Enter fluid's kinematic viscosity. It only can be used when item "Other" is selected in Window M20, i.e. it is unnecessary to enter all the fluids that listed in Window M20.



### Transducer Mounting

Three mounting methods are available:

- 0. V (sound wave bounces 2 times)
- 1. Z (sound wave bounces once. The most commonly used method)
- 2. N (small pipe, sound wave bounces 3 times)



### Transducer Spacing

(This value is calculated by the flow meter)

The operator must mount the transducer according to the transducer spacing displayed (be sure that the transducer spacing is measured precisely during installation). The system will display the data automatically after the pipe parameter has been entered.



### Initial Parameter Setups and Save

Load and save the parameters. 18 different sets of setup conditions/groups are available to load and save by three methods (i.e.-you can load and save 18 different applications):

- 0. Entry to Save
- 1. Entry to Load
- 2. To Browse

Select "Entry to Save", press . An ID code and the original parameters are displayed in the window. Press UP or DOWN ARROW to move the ID code, then press the  key again to save the current parameter in the current ID file.

When selecting "Entry to Load", press ENT, and the system will read and calculate the parameters



automatically and display the transducer mounting spacing in Window M25.



### **Cross-Sectional Area**

Display the cross-sectional area inside the pipe.

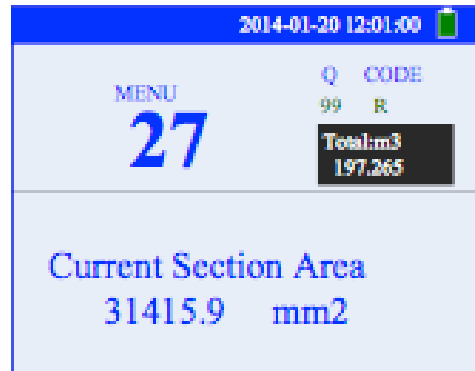

### **Holding With Poor Sig**

Select "Yes" to hold last good flow signal displayed if the flow meter experiences a poor temporary signal condition. This function will allow continued data calculation without interruption.



### **Empty Pipe Setup**

This parameter is used to overcome the possible problems that usually show up when the pipe being measured is empty. Since signals can be transmitted through the pipe wall, the flow meter may still read a flow while measuring an empty pipe. To prevent this from happening, you can specify a value. When the signal quality falls below this value, the measurement stops automatically. If the flow meter is already able to stop measuring when the pipe is empty, a value in the range of 30 to 40 should be entered in this window to ensure no measurement when the pipe is empty.

It should be understood that the instrument is NOT designed to function correctly on an empty pipe.





### **Measurement Units**

Select the measurement unit as follows:

- 0. Metric
- 1. English

Factory default is Metric.



### **Flow Rate Units Options**

The following flow rate units are available:

- 0. Cubic Meters (m3)
- 1. Liters (L)
- 2. USA Gallons (GAL)
- 3. Imperial Gallons (Imp gal)
- 4. Million Gallons (mg)
- 5. Cubic Feet (cf)
- 6. USA Barrels (US bbl)
- 7. Imperial Barrels (Imp bbl)
- 8. Oil Barrels (Oil bbl)

The following time units are available:

/Day /Hour /Min /Sec

Factory default is Cubic Meters/hour.

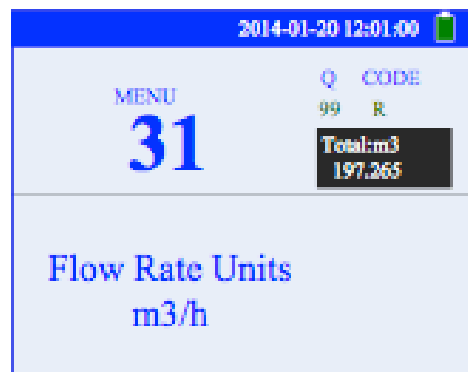

### **Totalizer Units Options**

Select totalizer units. The available unit options are as same as those found in Window M31. The user can select units as their required.

Factory default is Cubic Meters





### **Totalizer Multiplier Options**

The totalizer multiplier acts as the function to increase the totalizer indicating range. Meanwhile, the totalizer multiplier can be applied to the positive totalizer, negative totalizer and net totalizer at the same time. The following options are available:

- 0. x 0.001 (1E-3)
- 1. x 0.01
- 2. x 0.1
- 3. x 1
- 4. x 10
- 5. x 100
- 6. x 1000
- 7. x 10000(1E+4)

Factory default factor is x1



### **ON/OFF POS Totalizer**

On/Off positive totalizer. "ON" indicates the flow meter starts to totalize. When it is turned off, the positive totalizer is displayed in Window M02. Factory default is "ON".



### **ON/OFF NEG Totalizer**

On/Off negative totalizer. "ON" indicates the totalizer is turned on. When it is turned off, the negative totalizer displays in Window M03.

Factory default is "ON".





### Totalizer Reset

Totalizer reset; all parameters are reset. Press ; move or arrow to select "YES" or "NO". After "YES" is selected, the following options are available:

None, All, NET, POS, NEG

If it is necessary to recover the factory default, press keys after the above-mentioned characters are displayed on the screen.

Generally, it is unnecessary to activate this function except during the initial installation.



### CAUTION

This operation will cancel all the data and revert back to factory default. Be careful with this operation.



### Manual Totalizer

The manual totalizer is a separate totalizer. Press to start, and press to stop it. It is used for flow measurement and calculation.



### Damping

The damping factor ranges from 0~999 seconds. 0 indicates no damping; 999 indicate the maximum damping. The damping function will stabilize the flow display. Usually a damping factor of 3 to 10 is recommended in most applications.





### Low Flow Cutoff Value

If the flow rate falls below the low flow cutoff value, the flow indication is driven to zero. This function can prevent the flow meter from reading flow after pump shut down but there is still liquid movement in the pipe, which will result in totalization error.

Generally, 0.03m/s is recommended to enter as the low flow cutoff point.

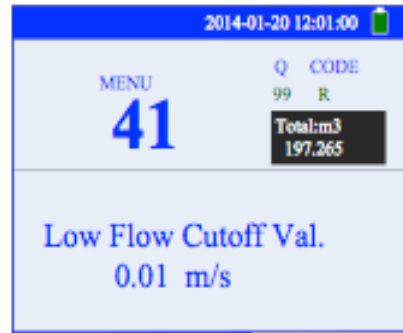

### Set Zero

When fluid is in the static state (no movement), the displayed value is called "Zero Point". If the "Zero Point" function is used when the flow is not at true zero. The difference is going to be added into the actual flow values and measurement differences will occur in the flow meter.

Set zero must be carried out after the transducers are installed and the flow inside the pipe is in the absolute static state (no liquid movement in the pipe). Thus, the "Zero Point" resulting from different pipe mounting location and parameters can be eliminated. The measuring accuracy at low flow is enhanced by doing this function and flow offset is eliminated.



Press  , wait for the processing instructions at the bottom right corner of the display to reach 0.

Performing set zero with existing flow may cause the flow to be displayed as "0". If so, it can be recovered via Window M43.



### Reset Zero

Select "YES"; reset "Zero Point" which was set by the user.





### **Manual Zero Point**

This method is not commonly used. It is only suitable for experienced operators to set zero under conditions when it is not preferable to use other methods.

Enter the value manually to add to the measured value to obtain the actual value. For example:

Actual measured value = 250 m3/H

Value Deviation = 10 m3/H

Flow meter Display = 240 m3/H

Normally, set the value as "0".



### **Scale Factor**

The scale factor is used to modify the measurement results over entire the meter range. The user can enter a numerical value other than "1" according to calibration results.



### **Network IDN**

Input RS-485 device ID Number. Any number can be selected from 1~247 except for decimal 13, 10, 42, and 38.

All meters on a network need to have a unique address



### **System Lock**

Lock the instrument.

Once the system is locked, any modification to the system is prohibited, but the parameter is readable. "Unlock" using your designated password. The password is composed of 6 numbers.







### Segmented Correction

This is a polynomial style linearity adjustment with 16 groups of 16 correction coefficients for sectionally correcting measurement results. To use this you need to input the password "115800", then press  key to expand the menu. The user can input 16 actual scale factor, referring to his calibration results across the flow meter range.

Only used by advanced users with a flow standard better than the .5% accuracy.

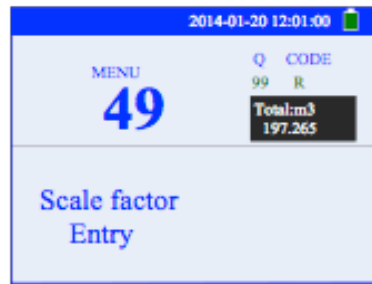

### Current Loop Mode Select

- 0. 4~20mA output mode
- 1. 4~20mA Corresponding Velocity

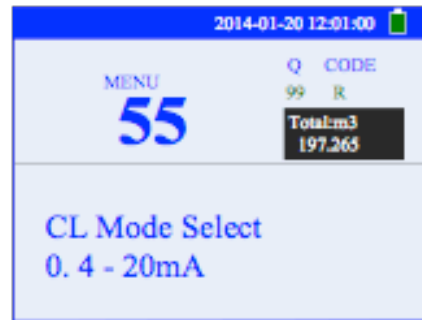

### CL 4mA Output Value

Set the CL output value according to the flow value at 4mA. Window M55, the unit should be set as m/s if it is the velocity unit selected 4mA. The flow unit's options are as some as those in Window M31. Once "velocity 4-20mA" is selected in Window M55, the unit should be set as m/s if it is the velocity unit selected.



### 20mA Output Value

Set the CL output value according to the flow value at 20mA. The flow unit is the same as that found in Window M31. Once "velocity 4~20mA" is selected in Window M55, the unit should be set as m/s, if m/s is the velocity selection.

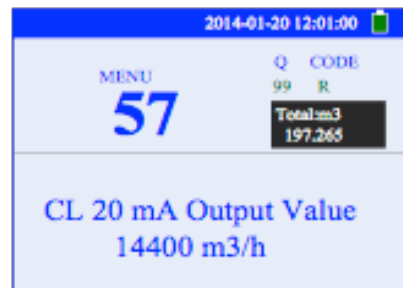



### CL Check Verification

Check if the current loop has been calibrated before leaving the factory. Press  move  or  separately to display 0mA, 4mA till 24mA, and at the same time, check with an ammeter to verify that CL output terminals M31 and 32 agree with the displayed values. It is necessary to re-calibrate the CL if it is over the permitted tolerance. For more information, refer to “4-20mA Current Loop Calibration”.

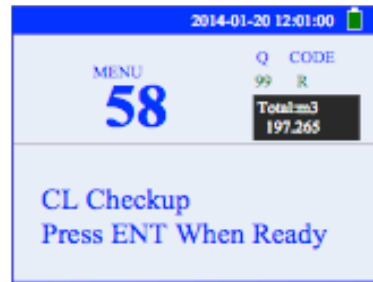

### CL Current Output

Display CL current output. The display of 10.0000mA indicates that CL current output value is 10.0000mA. If the difference between displaying value and CL output value is too large, the current loop then needs to be recalibrated accordingly.



### Date and Time Settings

Generally, it is unnecessary to modify date time as the system is provided with a highly reliable perpetual calendar chip.

The format for setting time setting is 24 hours. Press , wait until “>” appears, the modification can be made.

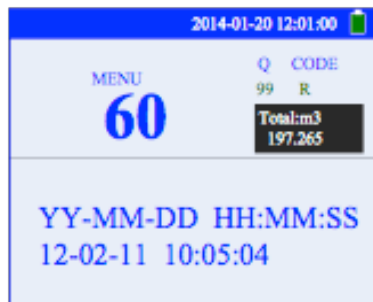

### Working Timer

Display the totalized working hours of the flow meter since last reset. It is displayed by HH:MM:SS. If it is





### **Beeper Setup**

Set up the beeper ON/OFF state.

0. ON Beeper ON
1. OFF Beeper OFF



### **Signal Strength and Signal Quality**

Display the measured signal strength and signal quality Q value upstream and downstream.

Signal strength is indicated from 00.0~99.9. A reading of 00.0 indicates no signal detected, while 99.9 indicates maximum signal strength. Normally the signal strength should be  $\geq 60.0$ . Signal quality Q is indicated by 00~99. Therefore, 00 indicates the poorest signal while 99 indicates the best signal. Normally, signal quality Q value should be better than 50.



### **TOM/TOS\*100**

Display the ratio between the actual measured transmit time and the calculated transmit time according to customer's requirement. Normally the ratio should be  $100 \pm 3\%$ . If the difference is too large, the user should check that the parameters are entered correctly, especially the sound velocity of the fluid and the installation of the transducers. Flow data outside this range would not be accurate. To change this value, slightly change the transducer spacing until the desired +/- 0.3% window is attained.

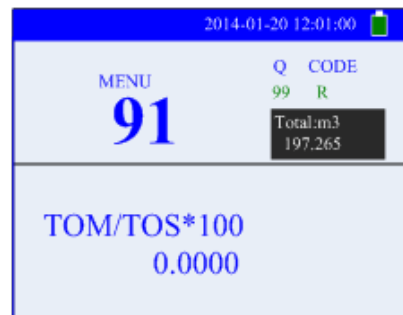

### **Fluid Sound Velocity**

Display the measured fluid sound velocity. Normally this value should be approximately equal to the entered value in Window M21. If the difference is too large, it probably results from an incorrect value entered in Window M21 or improper installation of the transducers





### Total Time and Delta Time

Display the measured ultrasonic average time (unit: nS) and delta time of the upstream and downstream (unit: nS) time. The velocity calculation in the flow meter is based on the two readings. The delta time is the best indication that the instrument is running steadily. Normally the fluctuation in the ratio of the delta time should be lower than 20%. If it is not, it is necessary to check if the transducers are installed properly or if the parameters have been entered correctly.

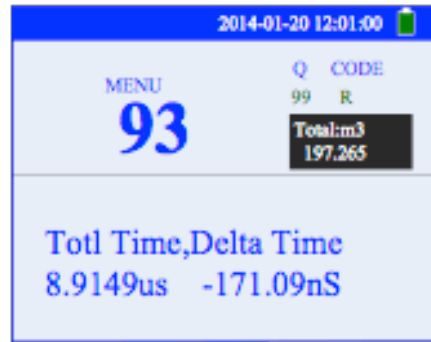

### Reynolds Number and Factor

Display the Reynolds number that is calculated by the flow meter and the factor that is set currently by the flow meter. Normally this scaling factor is the average of the line and surface velocity factor inside the pipe.

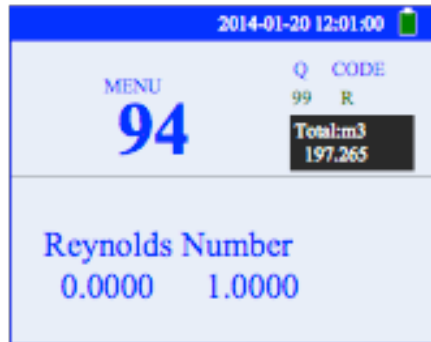

### Time Fixed Delay

Display the time fixed delay.

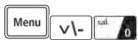

### 4-20 mA Hardware Adjustment

Please refer to Section 5.6 to adjust the 4~20mA Analog Output.



## 7. Error Diagnostics

The ultrasonic flow meter has advanced self-diagnostics functions and displays any errors in the upper right corner of the LCD via definite codes in a date/time order. Hardware error diagnostics are usually performed upon each power on. Some errors can be detected during normal operation. Undetectable errors caused by incorrect settings and unsuitable measurement conditions can be displayed accordingly. This function helps to detect the errors and determine causes quickly; thus, problems can be solved in a timely manner according to the solutions listed in the following tables.

Errors displayed in the flow meter are divided into two categories:

Table 1 is for errors displayed during self-diagnostics upon power on. “\*F” may be displayed on the upper left corner of the screen after entering the measuring mode. When this occurs, it is necessary to power on for self-diagnostics once again to detect and solve possible errors using the table below. If a problem still exists, please contact the factory or the factory’s local representative for assistance.

Table 2 applies when errors caused by incorrect settings and signals are detected and are announced by error codes displayed in Window M08.

### 7.1. Table 1. Self-diagnosis and Error Solutions (upon power on)

LCD Display	Cause	Solution
Rom Parity Error	* System ROM illegal or error	* Contact the factory
Stored Data Error	* System stored data block error	* Power on again or contact the factory
SCPU Fatal Error	* SCPU circuit fatal error	* Power on again or contact the factory
Timer Slow Error Timer Fast Error	* System clock error	* Contact the factory
CPU or IRQ Error	CPU or IRQ problem	* Power on again
System RAM Error	* System RAM questionable	* Power on again or contact the factory
Time or Bat Error	* System date time chip error	* Power on again or contact the factory
No Display, Erratic or Abnormal Operation	* Bad wiring connection	* Check wiring connections

## 7.2. Table 2. Error Codes and Solutions (during operation)

Code	M08 Display	Cause	Solution
*R	System Normal	* System normal	* No errors
*J	SCPU Fatal Error	* Hardware defect	* Contact the factory
*I	Signal Not Detected	<ul style="list-style-type: none"> <li>* Signal not detected</li> <li>* Spacing is not correct between the transducers or not enough coupling compound applied to face of transducers.</li> <li>* Transducers installed improperly.</li> <li>* Scale is too thick.</li> <li>* New pipe liner.</li> </ul>	<ul style="list-style-type: none"> <li>* Attach transducer to the pipe and tighten it securely. Apply a plenty of coupling compound on transducer and pipe wall.</li> <li>* Remove any rust, scale, or loose paint from the pipe surface. Clean it with a file.</li> <li>* Check the initial parameter settings.</li> <li>* Remove the scale or change the scaled pipe section. Normally, it is possible to change a measurement location. The instrument may run properly at a new site with less scale.</li> <li>* Wait until liners solidified and saturated.</li> </ul>
*H	Low Signal Strength	<ul style="list-style-type: none"> <li>* Low signal strength.</li> <li>* Cause refers to above-mentioned reasons.</li> </ul>	* Solution refers to above-mentioned solutions
*H	Poor Signal Quality	<ul style="list-style-type: none"> <li>* Poor signal quality</li> <li>* All reasons are included in the above-mentioned causes.</li> </ul>	* Solution refers to above-mentioned solutions
*E	Current Loop over 20mA	<ul style="list-style-type: none"> <li>* 4-20mA current loop over 120%.</li> <li>* Improper settings to current loop output.</li> </ul>	* Check settings (refer to Window M56) and confirm if actual flow is too high.
*F	Refer to Table 1	<ul style="list-style-type: none"> <li>* Error in self-diagnoses during power on.</li> <li>* Permanent hardware error. n.</li> </ul>	<ul style="list-style-type: none"> <li>* Power on again; resolve it by the method listed in Table 1. If it is still a problem, contact the factory.</li> <li>* Contact the factory.</li> </ul>
*G	Adjusting Gain>S1 Adjusting Gain>S2 Adjusting Gain>S3 Adjusting Gain>S4 (Display in Windows M00, M01, M02, M03)	<ul style="list-style-type: none"> <li>* Adjusting gain for normal measurement.</li> <li>* Stop in S1 or S2 and only switch between S1 and S2 indicates a poor waveform or low signal strength. All reasons may be included in above-mentioned items.</li> </ul>	

*K	Pipe Empty. Set in Window M29	* No fluid in pipe or settings incorrect.	* Once fluid is detected in the pipe, set 0 in Window M29.
----	-------------------------------	---	--

### 7.3. Frequently Asked Questions and Answers

Question: New pipe, high quality material, and all installation requirements met: Why still no signal detected?

Answer: Check pipe parameter settings, installation method and wiring connections. Confirm if the coupling compound is applied adequately, the pipe is full of liquid, transducer spacing agrees with the screen readings and the transducers are installed in the right direction.

Question: Old pipe with heavy scale inside, no signal or poor signal detected: How can it be resolved?

Answer: Check if the pipe is full of fluid. Try the Z method for transducer installation (If the pipe is too close to a wall, or it is necessary to install the transducers on a vertical or inclined pipe with flow upwards instead of on a horizontal pipe).

Carefully select a good pipe section and fully clean it, apply a wide band of coupling compound on each transducer face (bottom) and install the transducer properly.

Slowly and slightly move each transducer with respect to each other around the installation point until the maximum signal is detected. Be careful that the new installation location is free of scale inside the pipe and that the pipe is concentric (not distorted) so that the sound waves do not bounce outside of the proposed area.

For pipe with thick scale inside or outside, try to clean the scale off, if it is accessible from the inside. (Note: Sometimes this method might not work and sound wave transmission is not possible because of a layer of scale between the transducers and pipe inside wall).

Question: Why is there no CL (current loop) output?

Answer: Check if the desired current output mode is set in Window M55. See if the CL is powered off by "CL Off" settings.

Open the electronics enclosure to inspect the hardware circuit. Check to see if the short-circuit terminal near terminal 3 is in place, i.e. Direct Output Mode (set CL output as Transmitter Mode with external power supply).

Question: Why is the CL output abnormal?

Answer: Check to see if the desired current output mode is set in Window M55.

Check to see if the maximum and minimum current values are set properly in Windows M56 and M57.

Re-calibrate CL and verify it in Window M49.

Question: Why is the flow rate still displayed as zero while there is fluid obviously inside the pipe and a symbol of "R" displayed on the screen?

Answer: Check to see if "Set Zero" was carried out with fluid flowing inside the pipe (Refer to Window M42). If it is confirmed, recover the factory default in Window M43.

# 8. Product Overview

## 8.1 Introduction

The model 210 handheld ultrasonic flow meter is a state-of-the-art universal transit-time flow meter designed using SLSI technology and low-voltage broadband pulse transmission. While principally designed for clean liquid applications, the instrument is tolerant of liquids with the small amounts of air bubbles or suspended solids found in most industrial environments.

## 8.2 Features of Flow meter

With distinctive features such as high precision, high reliability, high capability and low cost, the flow meter features other advantages:

- 1) Use of an SLSI COMA chip means low power consumption, high reliability and anti-jamming.
- 2) Clear, user-friendly menu selections make flow meter simple and convenient to use.  
U.S., British and Metric measurement units are available.
- 3) Daily, monthly and yearly totalized flow: Totalized flow for the last 64 days and months as well as for the last 5 years are may be viewed. Power on/off function: 4. With the SD Card, 512 files can be stored; the time interval can be within 5 seconds.
- 4) Parallel operation of positive, negative and net flow totalizes with scale factor and 7 digit display. The flow meter ensures the highest resolution and wide measuring range with 0.04nS high resolution, high linearity and high stability time measuring circuit and 32 bits digits processing program.

## 8.3 Theory of Operation

When the ultrasonic signal is transmitted through the flowing liquid, there will be a difference between the upstream and downstream transit time (travel time or time of flight), which is proportional to flow velocity, according to the formula below.

$$V = \frac{MD}{\sin 2\theta} \times \frac{\Delta T}{T_{up} \bullet T_{down}}$$

Remarks:

- $V$  Medium Velocity
- $M$  Ultrasonic frequency of reflection
- $D$  Pipe Diameter
- $\theta$  The angle between the ultrasonic signal and the flow
- $T_{up}$  Transit time in the forward direction
- $T_{down}$  Transit time in the reverse direction
- $\Delta T = T_{up} - T_{down}$

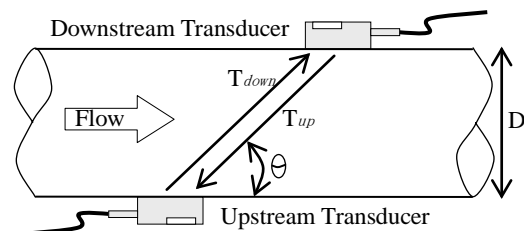



## 8.4. Applications

- Water, sewage (with low particle content) and seawater
- Water supply and drainage water
- Power plants (nuclear power plant, thermal and hydropower plants), heat energy, boiler feed water and energy management system
- Metallurgy and mining applications (cooling water and acid recovery, for example)
- Petroleum and chemicals
- Food, beverage and pharmaceutical
- Marine operation and maintenance
- Energy economy supervision and water conservation management
- Pulp and paper (clean liquid applications)
- Pipeline leak detection
- Regular inspection, tracking and collection
- Energy measuring and balance
- Network monitoring systems and energy/flow computer management

## 8.5. Specifications

2

### PERFORMANCE SPECIFICATIONS

#### Accuracy

+/- 0.5% of reading from 0.03 to 40 ft/s (0.01 to 12 m/s)

#### Repeatability

+/- 0.1% of full scale

#### Pipe Size

2 to 236 inches (50.8 to 6000 mm)

### OPERATING SPECIFICATIONS

#### Flow Range

0.03 to 40 ft/s (0.01 to 12 m/s)

#### Temperature

Ambient: 14°F to 122°F (-10°C to 50°C)

Operating: -40°F to 176°F (-40°C to 80°C)

#### Power Supply

11.1 VDC rechargeable lithium-ion battery (continuous operation of up to 10 hours)

#### Output

Analog: 4 to 20 mA current loop (max load 750  $\Omega$ )

#### Keypad

24 tactile keys with 12 dual-function and 7 quick setup keys

#### Display

3.5 inch backlit color LCD display (320 x 240)

#### Humidity

Up to 99% RH (non-condensing)

#### Data Logging

2 GB SD memory card for high-capacity data logging  
1 minute to 48 hour collection time

### PHYSICAL SPECIFICATIONS

#### Transmitter

NEMA 13 (IP 54)

#### Transducer

Encapsulated design IP 68

Standard cable length: 16 ft (5 m)

Maximum cable length: 100 ft (30 m)

#### Electronics Dimensions

Transmitter: H = 7.8 inches (19.5 cm) W = 5.3 inches (13.5 cm) D = 1.4 inches (3.5 cm)

Transducer: H = 11.75 inches (29.85 cm) W = 1.5 inches (3.81 cm) D = 1.5 inches (3.81 cm)

#### Weight

Transmitter: 1.4 lbs (.6 kg)

Transducer: 1 lbs (.4 kg)

### OPTIMAL INSTALLATION LOCATION

#### Transducer Installation Examples

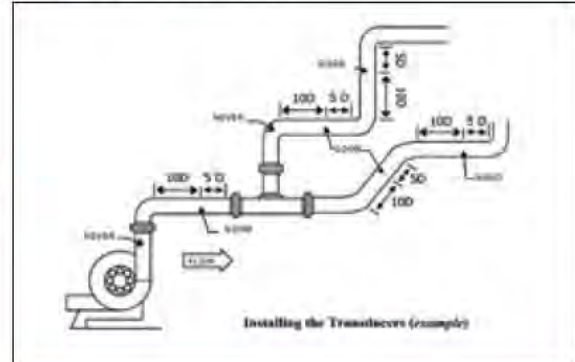

### TRANSDUCER SPACING REQUIREMENTS

#### Z Method Transducer Spacing

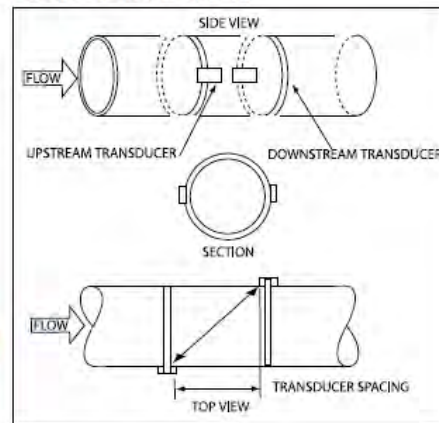

#### V Method Transducer Spacing

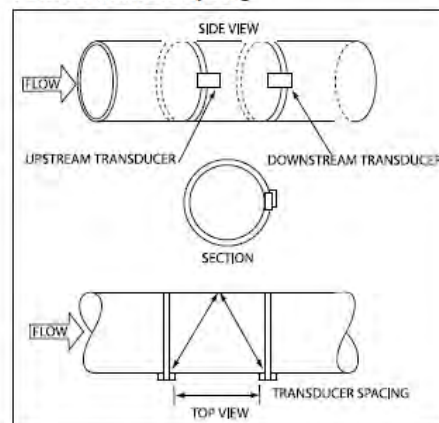



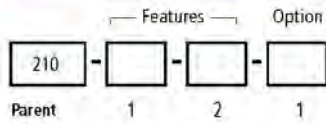

Instructions: To order a 210 please fill in each number block by selecting the codes from the corresponding features below and following pages.

Parent Model Number	
<b>210</b>	InnovaSonic® Portable Ultrasonic Transit-Time Liquid Flow Meter
Feature 1: Interface	
<b>1</b>	Push-button data entry with 24 tactile keys; 12 dual function and 7 quick setup keys; comes with display
Feature 2: Transducers and Cable Length	
<b>16</b>	Clamp-on portable transducers with two magnetic mounting racks. Operating temperature -40°F to 176°F (-40°C to 80°C), 16 ft. (5m) standard cable length. Longer lead time for longer cable lengths.
Option: NIST Traceable Certificate	
<b>NIST</b>	5-point calibration certification traceable to NIST. Add two weeks to standard delivery.

## 9. Appendix1 - Flow Application Data

### 9.1 Sound Velocity and Viscosity for Fluids Commonly Used

Fluid	Sound Velocity (m/s)	Viscosity
Water 20°C	1482	1.0
Water 50°C	1543	0.55
Water 75°C	1554	0.39
Water 100°C	1543	0.29
Water 125°C	1511	0.25
Water 150°C	1466	0.21
Water 175°C	1401	0.18
Water 200°C	1333	0.15
Water 225°C	1249	0.14
Water 250°C	1156	0.12
Acetone	1190	
Carbine	1121	
Ethanol	1168	

Alcohol	1440	1.5
Glycol	1620	
Glycerin	1923	1180
Gasoline	1250	0.80
Benzene	1330	
Toluene	1170	0.69
Kerosene	1420	2.3
Petroleum	1290	
Retinal	1280	
Aviation kerosene	1298	
Peanut oil	1472	
Castor oil	1502	

## 9.2 Sound Velocity for Various Materials Commonly Use

Pipe Material	Sound Velocity (m/s)
Steel	3206
ABS	2286
Aluminum	3048
Brass	2270
Cast iron	2460
Bronze	2270
Fiber glass-epoxy	3430
Glass	3276
Polyethylene	1950
PVC	2540

Liner Material	Sound Velocity (m/s)
PTFE	1225
Titanium	3150
Cement	4190
Bitumen	2540
Porcelain enamel	2540
Glass	5970
Plastic	2280
Polyethylene	1600
PTFE	1450
Rubber	1600

### 9.3 Sound Velocity in Water (1 atm) at Different Temperatures

t (°C)	v(m/s)
0	1402.3
1	1407.3
2	1412.2
3	1416.9
4	1421.6
5	1426.1
6	1430.5
7	1434.8
8	1439.1
9	1443.2
10	1447.2
11	1451.1
12	1454.9
13	1458.7
14	1462.3
15	1465.8
16	1469.3
17	1472.7
18	1476.0
19	1479.1
20	1482.3
21	1485.3
22	1488.2
23	1491.1
24	1493.9
25	1496.6
26	1499.2
27	1501.8
28	1504.3
29	1506.7
30	1509.0
31	1511.3
32	1513.5
33	1515.7
34	1517.7
35	1519.7
36	1521.7
37	1523.5
38	1525.3

39	1527.1
40	1528.8
41	1530.4
42	1532.0
43	1533.5
44	1534.9
45	1536.3
46	1537.7
47	1538.9
48	1540.2
49	1541.3
50	1542.5
51	1543.5
52	1544.6
53	1545.5
54	1546.4
55	1547.3
56	1548.1
57	1548.9
58	1549.6
59	1550.3
60	1550.9
61	1551.5
62	1552.0
63	1552.5
64	1553.0
65	1553.4
66	1553.7
67	1554.0
68	1554.3
69	1554.5
70	1554.7
71	1554.9
72	1555.0
73	1555.0
74	1555.1
75	1555.1
76	1555.0
77	1554.9
78	1554.8

79	1554.6
80	1554.4
81	1554.2
82	1553.9
83	1553.6
84	1553.2
85	1552.8
86	1552.4
87	1552.0
88	1551.5
89	1551.0
90	1550.4
91	1549.8
92	1549.2
93	1548.5
94	1547.5
95	1547.1
96	1546.3
97	1545.6
98	1544.7
99	1543.9

Please contact the factory for other sound velocity of fluids and material.

## 9.4 Common Pipe Dimensions (English)

OD	INCH		SCHEDULE		WALL	ID
1/8"	0.405"	10		10S	0.049"	0.307"
1/8"	0.405"	STD	40	40S	0.068"	0.269"
1/8"	0.405"	XS	80	80S	0.095"	0.215"
1/4"	0.540"	10		10S	0.065"	0.410"
1/4"	0.540"	STD	40	40S	0.088"	0.364"
1/4"	0.540"	XS	80	80S	0.119"	0.302"
3/8"	0.675"	10		10S	0.065"	0.545"
3/8"	0.675"	STD	40	40S	0.091"	0.493"
3/8"	0.675"	XS	80	80S	0.126"	0.423"
1/2"	0.840"	5		5S	0.065"	0.710"
1/2"	0.840"	10		10S	0.083"	0.674"
1/2"	0.840"	STD	40	40S	0.109"	0.622"
1/2"	0.840"	XS	80	80S	0.147"	0.546"
1/2"	0.840"	160			0.188"	0.464"
1/2"	0.840"	XX			0.294"	0.252"
3/4"	1.050"	5		5S	0.065"	0.920"
3/4"	1.050"	10		10S	0.083"	0.884"
3/4"	1.050"	STD	40	40S	0.113"	0.824"
3/4"	1.050"	XS	80	80S	0.154"	0.742"
3/4"	1.050"	160			0.219"	0.612"
3/4"	1.050"	XX			0.308"	0.434"
1"	1.315"	5		5S	0.065"	1.185"
1"	1.315"	10		10S	0.109"	1.097"
1"	1.315"	STD	40	40S	0.133"	1.049"
1"	1.315"	XS	80	80S	0.179"	0.957"
1"	1.315"	160			0.250"	0.815"
1"	1.315"	XX			0.358"	0.599"
1 1/4"	1.660"	5		5S	0.065"	1.530"
1 1/4"	1.660"	10		10S	0.109"	1.442"
1 1/4"	1.660"	STD	40	40S	0.140"	1.380"
1 1/4"	1.660"	XS	80	80S	0.191"	1.278"
1 1/4"	1.660"	160			0.250"	1.160"
1 1/4"	1.660"	XX			0.382"	0.896"
1 1/2"	1.900"	5		5S	0.065"	1.770"
1 1/2"	1.900"	10		10S	0.109"	1.682"
1 1/2"	1.900"	STD	40	40S	0.145"	1.610"
1 1/2"	1.900"	XS	80	80S	0.200"	1.500"
1 1/2"	1.900"	160			0.281"	1.388"
1 1/2"	1.900"	XX			0.400"	1.100"
2"	2.375"	5		5S	0.065"	2.245"
2"	2.375"	10		10S	0.109"	2.157"
2"	2.375"	STD	40	40S	0.154"	2.067"
2"	2.375"	XS	80	80S	0.218"	1.939"



OD	INCH		SCHEDULE		WALL	ID
2"	2.375"	160			0.344"	1.687"
2"	2.375"	XX			0.436"	1.503"
2 1/2"	2.875"	5		5S	0.083"	2.709"
2 1/2"	2.875"	10		10S	0.120"	2.635"
2 1/2"	2.875"	STD	40	40S	0.203"	2.469"
2 1/2"	2.875"	XS	80	80S	0.276"	2.323"
2 1/2"	2.875"	160			0.375"	2.125"
2 1/2"	2.875"	XX			0.552"	1.771"
3"	3.500"	5		5S	0.083"	3.334"
3"	3.500"	10		10S	0.120"	3.260"
3"	3.500"	STD	40	40S	0.216"	3.068"
3"	3.500"	XS	80	80S	0.300"	2.900"
3"	3.500"	160			0.438"	2.624"
3"	3.500"	XX			0.600"	2.300"
3 1/2"	4.000"	5		5S	0.083"	3.834"
3 1/2"	4.000"	10		10S	0.120"	3.760"
3 1/2"	4.000"	STD	40	40S	0.226"	3.548"
3 1/2"	4.000"	XS	80	80S	0.318"	3.364"
3 1/2"	4.000"	XX			0.636"	2.728"
4"	4.500"	5		5S	0.083"	4.334"
4"	4.500"	10		10S	0.120"	4.260"
4"	4.500"				0.156"	4.188"
4"	4.500"				0.188"	4.124"
4"	4.500"	STD	40	40S	0.237"	4.026"
4"	4.500"	XS	80	80S	0.337"	3.826"
4"	4.500"	120			0.438"	3.624"
4"	4.500"	160			0.531"	3.438"
4"	4.500"	XX			0.674"	3.152"
4 1/2"	5.000"	STD	40	40S	0.247"	4.506"
4 1/2"	5.000"	XS	80	80S	0.355"	4.290"
4 1/2"	5.000"	XX			0.710"	3.580"
5"	5.563"	5		5S	0.109"	5.345"
5"	5.563"	10		10S	0.134"	5.295"
5"	5.563"	STD	40	40S	0.258"	5.047"
5"	5.563"	XS	80	80S	0.375"	4.813"
5"	5.563"	120			0.500"	4.563"
5"	5.563"	160			0.625"	4.313"
5"	5.563"	XX			0.750"	4.063"
6"	6.625"	5		5S	0.109"	6.407"
6"	6.625"	10		10S	0.134"	6.357"
6"	6.625"				0.188"	6.249"
6"	6.625"	STD	40	40S	0.280"	6.065"
6"	6.625"	XS	80	80S	0.432"	5.761"
6"	6.625"	120			0.562"	5.501"
6"	6.625"	160			0.719"	5.187"
6"	6.625"	XX			0.864"	4.897"

OD	INCH		SCHEDULE		WALL	ID
7"	7.625"	STD	40	40S	0.301"	7.023"
7"	7.625"	XS	80	80S	0.500"	6.625"
7"	7.625"	XX			0.875"	5.875"
8"	8.625"			5S	0.109"	8.407"
8"	8.625"	10		10S	0.148"	8.329"
8"	8.625"	20			0.250"	8.125"
8"	8.625"	30			0.277"	8.071"
8"	8.625"	STD	40	40S	0.322"	7.981"
8"	8.625"	60			0.406"	7.813"
8"	8.625"	XS	80	80S	0.500"	7.625"
8"	8.625"	100			0.594"	7.437"
8"	8.625"	120			0.719"	7.187"
8"	8.625"	140			0.812"	7.001"
8"	8.625"	XX			0.875"	6.875"
8"	8.625"	160			0.906"	6.813"
9"	9.625"	STD	40	40S	0.342"	8.941"
9"	9.625"	XS	80	80S	0.500"	8.625"
9"	9.625"	XX			0.875"	7.875"
10"	10.750"			5S	0.134"	10.482"
10"	10.750"			10S	0.165"	10.420"
10"	10.750"				0.188"	10.374"
10"	10.750"	20			0.250"	10.250"
10"	10.750"	30			0.307"	10.136"
10"	10.750"	STD	40	40S	0.365"	10.020"
10"	10.750"	XS	60	80S	0.500"	9.750"
10"	10.750"	80			0.594"	9.562"
10"	10.750"	100			0.719"	9.312"
10"	10.750"	120			0.844"	9.062"
10"	10.750"	140			1.000"	8.750"
10"	10.750"	160			1.125"	8.500"
11"	11.750"	STD	40	40S	0.375"	11.000"
11"	11.750"	XS	80	80S	0.500"	10.750"
11"	11.750"	XX			0.875"	10.000"
12"	12.750"			5S	0.156"	12.438"
12"	12.750"			10S	0.180"	12.390"
12"	12.750"	20			0.250"	12.250"
12"	12.750"	30			0.330"	12.090"
12"	12.750"	STD		40S	0.375"	12.000"
12"	12.750"	40			0.406"	11.938"
12"	12.750"	XS		80S	0.500"	11.750"
12"	12.750"	60			0.562"	11.626"
12"	12.750"	80			0.688"	11.374"
12"	12.750"	100			0.844"	11.062"
12"	12.750"	120			1.000"	10.750"
12"	12.750"	140			1.125"	10.500"
12"	12.750"	160			1.312"	10.126"

OD	INCH		SCHEDULE		WALL	ID
14"	14.000"			10S	0.188"	13.624"
14"	14.000"	10			0.250"	13.500"
14"	14.000"	20			0.312"	13.376"
14"	14.000"	STD	30	40S	0.375"	13.250"
14"	14.000"	40			0.438"	13.124"
14"	14.000"	XS		80S	0.500"	13.000"
14"	14.000"	60			0.594"	12.812"
14"	14.000"	80			0.750"	12.500"
14"	14.000"	100			0.938"	12.124"
14"	14.000"	120			1.094"	11.812"
14"	14.000"	140			1.250"	11.500"
14"	14.000"	160			1.406"	11.188"
16"	16.000"			10S	0.188"	15.624"
16"	16.000"	10			0.250"	15.500"
16"	16.000"	20			0.312"	15.376"
16"	16.000"	STD	30	40S	0.375"	15.250"
16"	16.000"	XS	40	80S	0.500"	15.000"
16"	16.000"	60			0.656"	14.688"
16"	16.000"	80			0.844"	14.312"
16"	16.000"	100			1.031"	13.938"
16"	16.000"	120			1.219"	13.562"
16"	16.000"	140			1.438"	13.124"
16"	16.000"	160			1.594"	12.812"
18"	18.000"			10S	0.188"	17.624"
18"	18.000"	10			0.250"	17.500"
18"	18.000"	20			0.312"	17.376"
18"	18.000"	STD		40S	0.375"	17.250"
18"	18.000"	30			0.438"	17.124"
18"	18.000"	XS		80S	0.500"	17.000"
18"	18.000"	40			0.562"	16.876"
18"	18.000"	60			0.750"	16.500"
18"	18.000"	80			0.938"	16.124"
18"	18.000"	100			1.156"	15.688"
18"	18.000"	120			1.375"	15.250"
18"	18.000"	140			1.562"	14.876"
18"	18.000"	160			1.781"	14.438"
20"	20.000"			10S	0.218"	19.564"
20"	20.000"	10			0.250"	19.500"
20"	20.000"	STD	20	40S	0.375"	19.250"
20"	20.000"	XS	30	80S	0.500"	19.000"
20"	20.000"	40			0.594"	18.812"
20"	20.000"	60			0.812"	18.376"
20"	20.000"	80			1.031"	17.938"
20"	20.000"	100			1.281"	17.438"
20"	20.000"	120			1.500"	17.000"
20"	20.000"	140			1.750"	16.500"
20"	20.000"	160			1.969"	16.062"

OD	INCH		SCHEDULE		WALL	ID
22"	22.000"		10	10S	0.250"	21.500"
22"	22.000"	STD	20	40S	0.375"	21.250"
22"	22.000"	XS	30	80S	0.500"	21.000"
22"	22.000"	60			0.875"	20.250"
22"	22.000"	80			1.125"	19.750"
22"	22.000"	100			1.375"	19.250"
22"	22.000"	120			1.625"	18.750"
22"	22.000"	140			1.875"	18.250"
22"	22.000"	160			2.125"	17.750"
24"	24.000"		10	10S	0.250"	23.500"
24"	24.000"	STD	20	40S	0.375"	23.250"
24"	24.000"	XS		80S	0.500"	23.000"
24"	24.000"	30			0.562"	22.876"
24"	24.000"	40			0.688"	22.624"
24"	24.000"	60			0.969"	22.062"
24"	24.000"	80			1.219"	21.562"
24"	24.000"	100			1.531"	20.938"
24"	24.000"	120			1.812"	20.376"
24"	24.000"	140			2.062"	19.876"
24"	24.000"	160			2.344"	19.312"
26"	26.000"		10		0.312"	25.376"
26"	26.000"	STD		40S	0.375"	25.250"
26"	26.000"	XS		80S	0.500"	25.000"
28"	28.000"		10		0.312"	27.376"
28"	28.000"	STD		40S	0.375"	27.250"
28"	28.000"		20	80S	0.500"	27.000"
28"	28.000"		30		0.625"	26.750"
30"	30.000"		10		0.312"	29.376"
30"	30.000"	STD		40S	0.375"	29.250"
30"	30.000"	XS	20	80S	0.500"	29.000"
30"	30.000"		30		0.625"	28.750"
32"	32.000"		10		0.312"	31.376"
32"	32.000"	STD			0.375"	31.250"
32"	32.000"		20		0.500"	31.000"
32"	32.000"		30		0.625"	30.750"
32"	32.000"		40		0.688"	30.264"
34"	34.000"		10		0.312"	33.376"
34"	34.000"	STD			0.375"	33.250"
34"	34.000"		20		0.500"	33.000"
34"	34.000"		30		0.625"	32.750"
34"	34.000"		40		0.688"	32.624"
36"	36.000"		10		0.312"	35.376"
36"	36.000"	STD		40S	0.375"	35.250"
36"	36.000"	XS		80S	0.500"	35.000"
42"	42.000"	STD		40S	0.375"	41.250"
42"	42.000"	XS		80S	0.500"	41.000"

<b>42"</b>	<b>42.000"</b>		<b>40</b>		<b>0.750"</b>	<b>40.500"</b>
<b>48"</b>	<b>48.000"</b>	<b>STD</b>		<b>40S</b>	<b>0.375"</b>	<b>47.250"</b>
<b>48"</b>	<b>48.000"</b>	<b>XS</b>		<b>80S</b>	<b>0.500"</b>	<b>47.000"</b>

## 9.5 Common Pipe Dimensions (DIN)

PIPE SIZES & SCHEDULES					
N.B.	N.B.	O.D.	WALL	Identification	
inches	mm	mm	mm	STD XS,XXS	Schedule Number
1	25	33.4	3.4	STD	40
1	25	33.4	4.5	XS	80
1	25	33.4	6.4		160
1	25	33.4	9.1	XXS	
1 ¼	32	42.2	3.6	STD	40
1 ¼	32	42.2	4.9	XS	80
1 ¼	32	42.2	6.4		160
1 ¼	32	42.2	9.7	XXS	
1 ½	40	48.3	3.7	STD	40
1 ½	40	48.3	5.1	XS	80
1 ½	40	48.3	7.1		160
1 ½	40	48.3	10.2	XXS	
2	50	60.3	3.9	STD	40
2	50	60.3	5.5	XS	80
2	50	60.3	8.7		160
2	50	60.3	11.1	XXS	
2 ½	65	73.0	5.2	STD	40
2 ½	65	73.0	7.0	XS	80
2 ½	65	73.0	9.5		160
2 ½	65	73.0	14.0	XXS	
3	80	88.9	5.5	STD	40
3	80	88.9	7.6	XS	80
3	80	88.9	11.1		160
3	80	88.9	15.2	XXS	
3 ½	90	101.6	5.7	STD	40
3 ½	90	101.6	8.1	XS	80
4	100	114.3	6.0	STD	40
4	100	114.3	8.6	XS	80
4	100	114.3	11.1		120
4	100	114.3	13.5		160
4	100	114.3	17.1	XXS	
5	125	141.3	6.6	STD	40
5	125	141.3	9.5	XS	80
5	125	141.3	12.7		120
5	125	141.3	15.9		160
5	125	141.3	19.0	XXS	

6	150	168.3	7.1	STD	40
6	150	168.3	11.0	XS	80
6	150	168.3	14.3		120
6	150	168.3	18.3		160
6	150	168.3	21.9	XXS	
8	200	219.1	6.4		20
8	200	219.1	7.0		30
8	200	219.1	8.2	STD	40
8	200	219.1	10.3		60
8	200	219.1	12.7	XS	80
8	200	219.1	15.1		100
8	200	219.1	18.3		120
8	200	219.1	20.6		140
8	200	219.1	22.2	XXS	
8	200	219.1	23.0		160
10	250	273.0	6.4		20
10	250	273.0	7.8		30
10	250	273.0	9.3	STD	40
10	250	273.0	12.7	XS	60
10	250	273.0	15.1		80
10	250	273.0	18.3		100
10	250	273.0	21.4		120
10	250	273.0	25.4	XXS	140
10	250	273.0	28.6		160
12	300	323.9	6.4		20
12	300	323.9	8.4		30
12	300	323.9	9.5	STD	
12	300	323.9	10.3	XS	40
12	300	323.9	12.7		
12	300	323.9	14.3		60
12	300	323.9	17.5		80
12	300	323.9	21.4		100
12	300	323.9	25.4	XXS	120
12	300	323.9	28.6		140
12	300	323.9	33.3		160
14	350	355.6	6.4		10
14	350	355.6	7.9		20
14	350	355.6	9.5	STD	30
14	350	355.6	11.1		40
14	350	355.6	12.7	XS	
14	350	355.6	15.1		60
14	350	355.6	19.0		80
14	350	355.6	23.8		100
14	350	355.6	27.8		120
14	350	355.6	31.8		140
14	350	355.6	35.7		160

PIPE SIZES & SCHEDULES					
N.B. inches	N.B. mm	O.D. mm	WALL mm	Identification	
				STD XS,XXS	Schedule number
16	400	406.4	6.4		10
16	400	406.4	7.9		20
16	400	406.4	9.5	STD	30
16	400	406.4	12.7	XS	40
16	400	406.4	16.7		60
16	400	406.4	21.4		80
16	400	406.4	26.2		100
16	400	406.4	31.0		120
16	400	406.4	36.5		140
16	400	406.4	40.5		160
18	450	457.0	6.4		10
18	450	457.0	7.9		20
18	450	457.0	9.5	STD	
18	450	457.0	11.1		30
18	450	457.0	12.7	XS	
18	450	457.0	14.3		40
18	450	457.0	19.0		60
18	450	457.0	23.8		80
18	450	457.0	29.4		100
18	450	457.0	34.9		120
18	450	457.0	39.7		140
18	450	457.0	45.2		160
20	500	508.0	6.4		10
20	500	508.0	9.5	STD	20
20	500	508.0	12.7	XS	30
20	500	508.0	15.1		40
20	500	508.0	20.6		60
20	500	508.0	26.2		80
20	500	508.0	32.5		100
20	500	508.0	38.1		120
20	500	508.0	44.4		140
20	500	508.0	50.0		160
22	550	559.0	6.4		10
22	550	559.0	9.5	STD	20
22	550	559.0	12.7	XS	30
22	550	559.0	22.2		60
22	550	559.0	28.6		80
22	550	559.0	34.9		100
22	550	559.0	41.3		120
22	550	559.0	47.6		140
22	550	559.0	54.0		160
24	600	610.0	6.4		10
24	600	610.0	9.5	STD	20
24	600	610.0	12.7	XS	
24	600	610.0	14.3		30
24	600	610.0	17.5		40
24	600	610.0	24.6		60
24	600	610.0	31.0		80



24	600	610.0	38.9		100
24	600	610.0	46.0		120
24	600	610.0	52.4		140
24	600	610.0	59.5		160
26	650	660.0	7.9		10
26	650	660.0	9.5	STD	
26	650	660.0	12.7	XS	20
28	700	711.0	7.9		10
28	700	711.0	9.5	STD	
28	700	711.0	12.7	XS	20
28	700	711.0	15.9		30
30	750	762.0	7.9		10
30	750	762.0	9.5	STD	
30	750	762.0	12.7	XS	20
30	750	762.0	15.9		30
32	800	813.0	7.9		10
32	800	813.0	9.5	STD	
32	800	813.0	12.7	XS	20
32	800	813.0	15.9		30
32	800	813.0	17.5		40
34	850	864.0	7.9		10
34	850	864.0	9.5	STD	20
34	850	864.0	12.7	XS	30
34	850	864.0	15.9		40
34	850	864.0	17.5		
36	900	914.0	7.9		10
36	900	914.0	9.5	STD	
36	900	914.0	12.7	XS	20
36	900	914.0	15.9		30
36	900	914.0	19.0		40

# 10. Appendix 2 - Warranty Policy

## 10.1 Limited Warranty Policy- Register Online

All Sierra products are warranted to be free from defects in material and workmanship and will be repaired or replaced at no charge to Buyer, provided return or rejection of product is made within a reasonable period but no longer than one (1) year for calibration and non-calibration defects, from date of delivery. To assure warranty service, customers must register their products online on Sierra's website. Online registration of all of your Sierra products is required for our warranty process. Register now at [www.sierrainstruments.com/register](http://www.sierrainstruments.com/register). Learn more about Sierra's warranty policy at [www.sierrainstruments.com/warranty](http://www.sierrainstruments.com/warranty).