

# Compod™

## Programmable Control Module For 100 Series Digital Mass Flow Meters & Controllers

### Instruction Manual

IM-COMPOD

Revision: I, November 2020



#### CORPORATE HEADQUARTERS

5 Harris Court, Building L, Monterey, CA 93940 USA

Phone (831) 373-0200

[www.sierrainstruments.com](http://www.sierrainstruments.com)

#### EUROPEAN HEADQUARTERS

Bijlmansweid 2 1934RE Egmond aan den Hoef

The Netherlands

Phone +31 72 507 1400

#### ASIA HEADQUARTERS

Rm. 618, Tomson Centre, Building A, 188 Zhang Yang Road

Pu Dong New District, Shanghai, P. R. China

Phone: +86 21 5879 8521

## IMPORTANT CUSTOMER NOTICE

Sierra Instruments, Inc. is not liable for any damage or personal injury, whatsoever, resulting from the use of Sierra Instruments standard mass flow meters or controllers for oxygen gas. You are responsible for determining if this mass flow meter or controller is appropriate for your oxygen application. You are responsible for cleaning the mass flow meter or controller to the degree required for your oxygen flow application.

### **© COPYRIGHT SIERRA INSTRUMENTS 2019**

No part of this publication may be copied or distributed, transmitted, transcribed, stored in a retrieval system, or translated into any human or computer language, in any form or by any means, electronic, mechanical, manual, or otherwise, or disclosed to third parties without the express written permission of Sierra Instruments. The information contained in this manual is subject to change without notice.

### **TRADEMARKS**

Compod™, Smart-Trak®, and Dial-A-Gas™ are trademarks of Sierra Instruments, Inc. Other product and company names listed in this manual are trademarks or trade names of their respective manufacturers.

**TABLE OF CONTENTS**

**IMPORTANT CUSTOMER NOTICE.....2**

**CHAPTER 1: INTRODUCTION.....7**

    Safety information ..... 7

**CHAPTER 2: INSTALLATION .....8**

**CHAPTER 3: ELECTRICAL CONNECTIONS.....9**

    Pin configuration ..... 9

    Instrument and Compod™ power ..... 10

    RS485 connection ..... 10

        General 2-wire topology RS485 network..... 11

        Daisy chain units ..... 11

    Analog inputs ..... 12

    Pulse output..... 12

    Digital outputs ..... 12

        Relay outputs..... 12

**CHAPTER 4: COMMUNICATING .....14**

    Power up..... 14

    Data format various registers ..... 14

    Modbus registers overview ..... 15

    Special – Modbus set up..... 17

    Registers explained..... 17

        40001: Actual flow ..... 17

        40003: Set point..... 17

        40005 – 40008: Totalizer ..... 18

        40009: Valve power ..... 18

        40010 - 40011: Analog inputs 1 & 2 ..... 18

        40012: Digital inputs..... 18

40013: Digital outputs .....	18
40014: Alarm status.....	18
40015: Factory full scale .....	18
40017: User full scale.....	18
40019: Gas span.....	19
40021: Trigger point low alarm 1 .....	19
40023: Trigger point high alarm 1 .....	19
40025: Trigger point low alarm 2 .....	19
40027: Trigger point high alarm 2 .....	19
40029: Alarm control register.....	19
40030: Trigger source alarm 1 .....	19
40031: Trigger source alarm 2 .....	19
40032: Analog input settings .....	19
40033: Pulse output control .....	20
40034: Gas index .....	20
40035: Valve position index.....	21
40036: Flow unit index .....	21
40037: Password.....	22
40038: Input set point index.....	22
40039: Analog output index .....	22
40040: Firmware revision .....	22
40042: Device type .....	22
40043 - 40046: Serial number .....	23
40047 - 40051: Tag .....	23
40052 – 40059: Gas name 1 .....	23
40060 – 40067: Gas name 2 .....	23

40068 – 40075: Gas name 3 .....	23
40076 – 40083: Gas name 4 .....	23
40084 – 40091: Gas name 5 .....	23
40092 – 40099: Gas name 6 .....	23
40100 – 40107: Gas name 7 .....	23
40108 – 40115: Gas name 8 .....	23
40116 – 40123: Gas name 9 .....	23
40124 – 40131: Gas name 10 .....	23
40132: Sensor data .....	23
40133: Set unit to zero .....	23
40134: Reset unit to factory default.....	23
Special Modbus set up registers.....	24
44100: ID.....	24
44101: Baud rate .....	24
44102: Parity.....	24
44103: TX delay.....	24
44104: Reset unit.....	24
<b>Chapter 5: Alarm system.....</b>	<b>25</b>
Alarm principle .....	25
Alarm control .....	25
Alarm control register.....	25
Trigger source .....	27
Trigger point (level) .....	27
Alarm status register .....	28
Examples.....	28
Flow high and low alarm.....	28

Shut down flow through external push button .....	29
Fill tank with gas to maintain pressure level .....	29
<b>Chapter 6: Display module .....</b>	<b>31</b>
Screen modes: .....	32
<b>Chapter 7: Bootloader.....</b>	<b>33</b>
Introduction .....	33
Getting started.....	33
Load Firmware (not typically required) .....	34
Setup Firmware.....	36
Quit .....	37
Trouble shooting.....	37
<b>APPENDIX A: COMPOD™ APPLICATION MANUAL .....</b>	<b>37</b>
<b>APPENDIX B: WARRANTY POLICY .....</b>	<b>45</b>

## CHAPTER 1: INTRODUCTION

The Compod™ is a Modbus add-on module for Sierra Instruments' Smart-Trak® Series 100 gas flow measurement and control instruments.

A variety of features enable the integration of the Smart-Trak® into a Modbus network environment. Among these features:

- Access to all vital data
- Sophisticated alarm system
- Totalizer
- Pulse output
- Analog inputs
- Smart-Trak® functionality monitor
- Digital outputs

## SAFETY INFORMATION

Caution and warning statements are used throughout this manual to draw your attention to important information.

Caution!



This statement appears with information that is important for protecting your equipment and performance. Read and follow all cautions that apply to your application

Warning!



This statement appears with information that is important to protect people and equipment from damage. Pay very close attention to all warnings that apply to your application



### ***TIP***

***TO FULLY UNDERSTAND THE COMPOD™ AND ITS FUNCTIONS IT IS ADVISED TO ALSO READ THE SMART-TRAK® SERIES 100 INSTRUCTION MANUAL***

## CHAPTER 2: INSTALLATION

When the Compod™ needs to be added to a Smart-Trak® please contact the factory.



## CHAPTER 3: ELECTRICAL CONNECTIONS

All electrical connections are made on the left side of the Compod™. There are two D9 connectors which give access to input power, network interface and other options.

### PIN CONFIGURATION

The image below shows the name of the connector and the location of “pin 1”

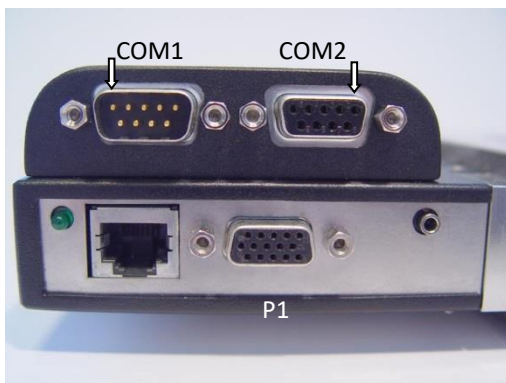

COM1

Pin	Function
1 (arrow)	RS485 Shield
2	+24V Power
3	ID0 – selection bit
4	ID1 – selection bit
5	RS485 – B
6	ID2 – selection bit
7	Ground
8	ID3 – selection bit
9	RS485 – A

COM2

Pin	Function
1 (arrow)	RS485 Shield
2	+24V Power
3	Analog input 1
4	Pulse out / Analog input 2
5	RS485 – B
6	Digital out1
7	Ground
8	Digital out2
9	RS485 – A



**THE PIN OUT FOR P1 CAN BE FOUND IN THE SMART-TRAK® SERIES 100 INSTRUCTION MANUAL**

During power-up or reset the ID pins (TTL compatible) are scanned. These pins set the Modbus ID code.

ID3	ID2	ID1	ID0	Modbus ID
open	open	open	open	Internal ID
open	open	open	GND	1
open	open	GND	open	2
open	open	GND	GND	3
-	-	-	-	
GND	GND	GND	GND	15

*(Connect the pin with ground to enable)*

## INSTRUMENT AND COMPOD™ POWER

The +24V power and power return (GND) of the instrument and the Compod™ are connected internally. Power can be applied in the following two ways:

1. Connect the power to the HD DB-15 connector (P1) of the instrument
2. Connect the power to one of the DB-9 connectors (COM1 or COM2) of the Compod™

### Power supply requirements

Instrument type	Recommended input voltage	Minimum current requirement (mA)
Meter	12-30 Vdc	250
Controller	24-30 Vdc	410

## RS485 CONNECTION



**THE COMPOD™ IS EQUIPPED WITH AN OPTICAL ISOLATED RS485 INTERFACE. DON'T CONNECT THE RS485 SHIELD TO THE GROUND OF THE POWER SUPPLY UNLESS THE ISOLATED BARRIER ISN'T REQUIRED.**

## GENERAL 2-WIRE TOPOLOGY RS485 NETWORK

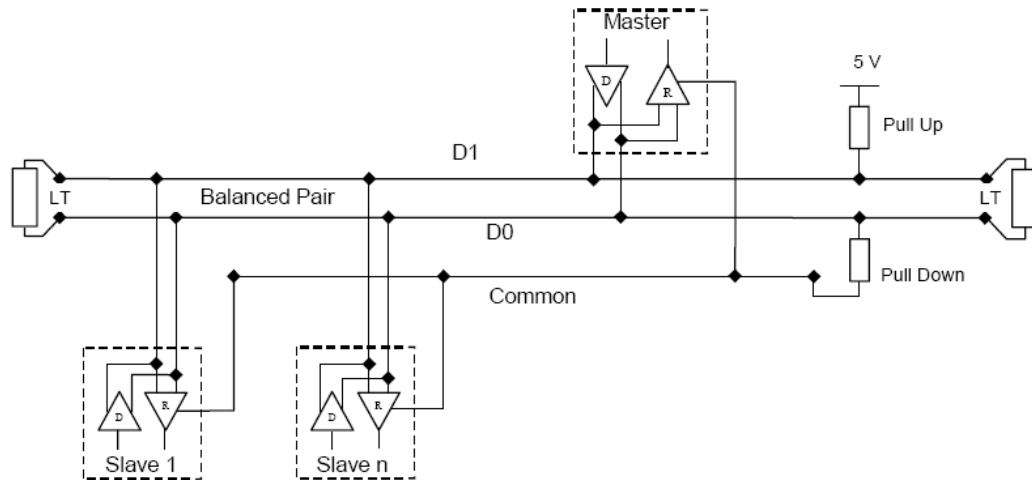

The “RS485 – A” (also referred as ‘-’) is connected with the D0 line. The “RS485 – B” (also referred as ‘+’) is connected with the D1 line. The shield is connected to the common line of the network. The use of line terminators depends on cable lengths and should be determined on site.

## DAISY CHAIN UNITS

It is possible to daisy chain a few units using the COM1 & COM2 connections. A special cable can be used to link the first unit through COM2 with the next unit through COM1.

The image below demonstrates how the units can be linked.

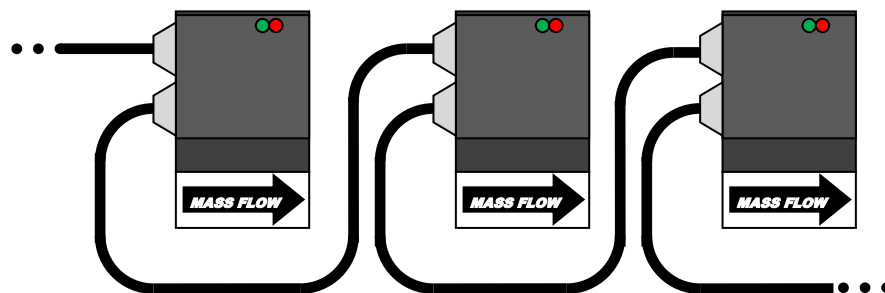



**THE NUMBER OF UNITS WHICH CAN BE LINKED DEPENDS ON THE TOTAL POWER CONSUMPTION. A MAXIMUM CURRENT OF 3 AMPS MUST NOT BE EXCEEDED!**

The following pins are used for the link cable:

- 1 (RS485 shield)
- 2 (+24V power)
- 5 (RS485 – B)
- 7 (Ground)
- 9 (RS485 – A)

## **ANALOG INPUTS**

The analog inputs can be used to connect various transducers (temperature, pressure etc.). Maximum input range is 0-10 Vdc or 0-20 mA. Various options can be set through the Modbus control register (40028). Analog input 2 (COM2-4) has a dual function. When the pulse output is enabled then the analog input will not be available.

## **PULSE OUTPUT**

The pulse output is a switch to ground with a series resistor of 250 ohms.



**THE MAXIMUM PULL-UP VOLTAGE IS 10 VDC; THE MAXIMUM CURRENT THE OUTPUT CAN SWITCH IS 20 MA. DO NOT EXCEED THESE VALUES OR DAMAGE MAY OCCUR.**

## **DIGITAL OUTPUTS**

There are two digital outputs available which can be controlled through Modbus. The outputs are TTL compatible.

The outputs are also be used the alarm system when enabled.

---

## **RELAY OUTPUTS**

If required the outputs can be changed into relay outputs through a special optional add-on. Please contact your sales representative for more information.



**NEVER CONNECT A REMOTE PILOT MODULE TO THE INSTRUMENT WHEN A COMPOD™ IS MOUNTED ON IT. DAMAGE CAN OCCURE.**

## CHAPTER 4: COMMUNICATING

Once the Compod™ is wired to the network and powered up it is time to communicate with it. The settings for the Modbus interface are as following:

- ID code = 1 (or 1 – 15 depending on the ID pin settings)
- Baud rate = 19200
- Parity = Even
- Number of bits = 8
- Stop bit = 1
- Delay between receiving and transmitting = 2 ms

The above settings are factory defaults and can be changed. Changing the settings can be done through the boot loader or special registers.

### POWER UP

When powered up the green LED on top of the Compod™ enclosure will flash twice. During this time it is possible to enter the boot loader (see Chapter 7 on boot loader for more information). After the flashing the red LED will light up indicating the initialization phase. During this time data is retrieved from the Smart-Trak® and stored into the Compod™ memory. There is no communication through Modbus possible at this stage.

Once all data is retrieved the red LED goes off and the green LED will start blinking as it receives data from the instrument. Communication through Modbus is possible now.

If the communication with the instrument is lost for some reason, the Compod™ will try to establish it again. During this phase the Modbus interface will not be active.

The red LED will light up every time a network message is received with the correct ID code.



*LED's showing the activities of the Compod™*

### DATA FORMAT VARIOUS REGISTERS

- 32 bit real: IEEE 754 floating point, low word first
- BCD encoded: hex encoded decimal values f.i. 0x89 = decimal 89
- 8 & 16 bits int: unsigned integer values
- 16 bits ASCII: ASCII encoded characters, high word = 1<sup>st</sup> character. 0x4944 = "ID"

## MODBUS REGISTERS OVERVIEW

PDU Address	Register	Description	Read/Write	Data type	No. registers
<b>Dynamic data</b>					
\$00	40001	Actual flow - low word	R	32 bits real	2
\$01	40002	Actual flow - high word			
\$02	40003	Set point - low word	R/W	32 bits real	2
\$03	40004	Set point - high word			
\$04	40005	Totalizer3,4	R/W (Reset)	BCD encoded	4
\$05	40006	Totalizer1,2	R		
\$06	40007	Totalizer7,8	R		
\$07	40008	Totalizer5,6	R		
\$08	40009	Valve power	R	16 bits int.	1
\$09	40010	Analog CH0	R	16 bits int.	1
\$0A	40011	Analog CH1	R	16 bits int.	1
\$0B	40012	Digital Data - IN	R	16 bits int.	1
\$0C	40013	Digital Data - OUT	R/W	16 bits int.	1
\$0D	40014	Alarm status	R/W	16 bit int.	1
<b>Settings</b>					
\$0E	40015	Factory f.s – low word	R	32 bits real	2
\$0F	40016	Factory f.s – high word			
\$10	40017	User f.s – low word	R/W	32 bits real	2
\$11	40018	User f.s – high word			
\$12	40019	Gas span – low word	R/W	32 bits real	2
\$13	40020	Gas span – high word			
\$14	40021	Trig1 Low – low word	R/W	32 bits real	2
\$15	40022	Trig1 Low – high word			
\$16	40023	Trig1 High – low word	R/W	32 bits real	2
\$17	40024	Trig1 High – high word			
\$18	40025	Trig2 Low – low word	R/W	32 bits real	2
\$19	40026	Trig2 Low – high word			
\$1A	40027	Trig2 High – low word	R/W	32 bits real	2
\$1B	40028	Trig2 High – high word			
\$1C	40029	Alarm Control register	R/W	16 bit int.	1
\$1D	40030	Trigger source 1	R/W	16 bit int.	1
\$1E	40031	Trigger source 2	R/W	16 bit int.	1
\$1F	40032	Analog input setting	R/W	8 bits int.	1
\$20	40033	Pulse out control	R/W	16 bits int.	1
\$21	40034	Gas index	R/W	8 bits int.	1
\$22	40035	Valve position index	R/W	8 bits int.	1
\$23	40036	Flow unit index	R/W	8 bits int.	1
\$24	40037	Password	R/W	16 bits int.	1
\$25	40038	Input set point index	R/W	8 bits int.	1
\$26	40039	Analog output index	R/W	8 bits int.	1
<b>Static data</b>					
\$27	40040	Device firm rev – low word	R	32 bits real	2

\$28	40041	Device firm rev – high word			
\$29	40042	Device type	R	16 bits ASCII	1
\$2A	40043	Serial number – char 1,2	R	16 bits ASCII	4
\$2B	40044	Serial number – char 3,4			
\$2C	40045	Serial number – char 5,6			
\$2D	40046	Serial number – char 7,8			
\$2E	40047	Tag number - char 1,2	R	16 bits ASCII	5
\$2F	40048	Tag number - char 3,4			
\$30	40049	Tag number - char 5,6			
\$31	40050	Tag number - char 7,8			
\$32	40051	Tag number - char 9,10			
\$33	40052	Gas 1 – char 1,2	R	16 bits ASCII	8
\$3A	40059	Gas 1 – char 15,16			
\$3B	40060	Gas 2 – char 1,2	R	16 bits ASCII	8
\$42	40067	Gas 2 – char 15,16			
\$43	40068	Gas 3 – char 1,2	R	16 bits ASCII	8
\$4A	40075	Gas 3 – char 15,16			
\$4B	40076	Gas 4 – char 1,2	R	16 bits ASCII	8
\$52	40083	Gas 4 – char 15,16			
\$53	40084	Gas 5 – char 1,2	R	16 bits ASCII	8
\$5A	40091	Gas 5 – char 15,16			
\$5B	40092	Gas 6 – char 1,2	R	16 bits ASCII	8
\$62	40099	Gas 6 – char 15,16			
\$63	40100	Gas 7 – char 1,2	R	16 bits ASCII	8
\$6A	40107	Gas 7 – char 15,16			
\$6B	40108	Gas 8 – char 1,2	R	16 bits ASCII	8
\$72	40115	Gas 8 – char 15,16			
\$73	40116	Gas 9 – char 1,2	R	16 bits ASCII	8
\$7A	40123	Gas 9 – char 15,16			
\$7B	40124	Gas 10 – char 1,2	R	16 bits ASCII	8
\$82	40131	Gas 10 – char 15,16			
\$83	40132	Sensor data	R	8 + 8 bit int.	1
\$84	40133	Set unit to zero	R/W (\$A5)	8 bits int.	1
\$85	40134	Reset unit to factory default	R/W (\$A5)	8 bits int.	1



## SPECIAL – MODBUS SET UP

PDU Address	Register	Description	Read/Write	Type	No. registers
\$1003	44100	ID (1-247)	R/W	16 bit int.	1
\$1004	44101	Baud rate 1 = 4800, 2 = 9600 3 = 19K2, 4 = 38K4 5 = 57K6	R/W	16 bit int.	1
\$1005	44102	Parity 1=none, 2=odd, 3=even	R/W	16 bit int.	1
\$1006	44103	TX delay (milliseconds)	R/W	16 bit int.	1
\$1007	44104	Reset unit: Read value from this register and write it back. This will reset the unit	R/W	16 bit int.	1

## REGISTERS EXPLAINED

The registers are divided into four groups. The first group (40001 – 40014) represents the dynamic data. This group changes the most. The second group (40015 – 40039) contains the settings from the instrument and Compod™ specific settings. The third group contains static data about the instruments. The last group (44100 – 44104) contains special functions to change the Modbus settings while the unit is in the network.

### Register descriptions

---

#### *40001: Actual flow*

The actual flow as measured by the instrument.

---

#### *40003: Set point*

When using a controller the set point is shown. Writing to this register will set the set point. When a set point is entered which is beyond the full scale of the instrument then the set point will be changed automatically to the full scale value.

---

#### ***40005 – 40008: Totalizer***

Totalizer value BCD encoded. The first two registers are the value left of the decimal point. The last two registers represent the value behind the decimal point.

Example:

40005 = 0x0010

40006 = 0x1204

40007 = 0x1654

40008 = 0x4500

Total = 12040010. 45001654

---

#### ***40009: Valve power***

Value representing the power injected into the valve (when using a controller). The value will range between 0 and 3200 (4095 when purging the valve).

---

#### ***40010 - 40011: Analog inputs 1 & 2***

Values from the analog inputs are presented as raw values ranging between 0 and 1023. The analog input settings determine the range.

---

#### ***40012: Digital inputs***

This value reflects the ID bits on P1 (true value, 0 = 0, 1 = 1). The ID pins can be used as TTL inputs but keep in mind that during power up these pins function as ID pins.

---

#### ***40013: Digital outputs***

Writing to this register will set the two available digital outputs (when not assigned to the alarm system). Digital output 1 is linked to bit 0 and digital output 1 is linked to bit 1 in the value.

---

#### ***40014: Alarm status***

Status indication for the alarms: See chapter about the alarm system for more information.

---

#### ***40015: Factory full scale***

Factory full scale value of the instrument

---

#### ***40017: User full scale***

The user full scale value allows you to re-range the instrument. Any value between 50% and 100% of the factory full scale is allowed. The new value will also redefine the analog outputs of the instrument (when used). The 20mA/5 Vdc will represent the new full scale value.

---

**40019: Gas span**

The gas span value allows you to re-range the full scale value of each available gas. This function is not supported on the first generation of Smart-Trak® instruments.

---

**40021: Trigger point low alarm 1**

Trigger value for the low point: See chapter about the alarm system for more information.

---

**40023: Trigger point high alarm 1**

Trigger value for the high point: See chapter about the alarm system for more information.

---

**40025: Trigger point low alarm 2**

Trigger value for the low point: See chapter about the alarm system for more information.

---

**40027: Trigger point high alarm 2**

Trigger value for the high point: See chapter about the alarm system for more information.

---

**40029: Alarm control register**

See chapter about the alarm system for more information.

---

**40030: Trigger source alarm 1**

Trigger source for alarm 1: See chapter about the alarm system for more information.

---

**40031: Trigger source alarm 2**

Trigger source for alarm 2: See chapter about the alarm system for more information.

---

**40032: Analog input settings**

This register controls the way the analog inputs behave. The table below shows the possible settings.

Bit	Function
	Analog input 1
0	Input multiplier, 0 = 1x, 1 = 0.5x
1	Input mode, 0 = voltage, 1 = current
	Analog input 2
2	Input multiplier, 0 = 1x, 1 = 0.5x
3	Input mode, 0 = voltage, 1 = current
	Common settings
7	Reference, 0 = 2.56V, 1 = 5V

When the pulse output is activated then analog input 2 will be disabled.

---

#### 40033: Pulse output control

When enabled (value not equal to zero) the pulse output will generate a pulse every time the totalizer will be incremented with a predefined value. The pulse output control register is divided into two parts. The low byte of the word represents the increment value N and the high byte represents the pulse width.

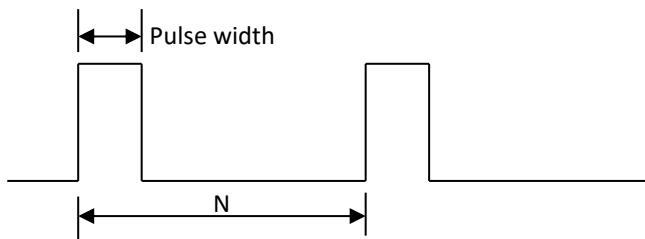

Register	Function
High byte	Pulse width = value x 2.5ms (max value = 200)
Low byte	N (max value = 255)

#### Example setting N:

Suppose the flow of the instrument is set to SLPM. When N = 10 then a pulse is generated each time the totalizer is incremented with at least 10 SL. Setting N to 1 will generate a pulse each time the totalizer is incremented with at least 1 SL.

#### Pulse width:

The pulse width can be set between 2.5 and 500 milliseconds. Keep in mind that at high flows the totalizer will increment fast and when N set to a low value the pulse width needs to be picked with care.

Example:

The flow is at a given point equal to 500 SLPM and N = 1. The totalizer will be incremented fast at a rate of  $500/60 = 8.333$  SL per second. This will mean that at least 8 pulses are generated per second (N = 1). If the pulse width is set to 500 msec (2 pulse per second) then pulses will get lost. The recommended pulse width will be  $1/(8+1) = 110$  msec. If the counter connected to the pulse output can't handle fast pulses then the N value needs to be increased.

---

#### 40034: Gas index

Value shows which gas is selected on the instrument. Value can range between 1 and 10.

---

#### 40035: Valve position index

Valve position index is the mode at which the valve of the controller will operate. The table shows the available values:

Value	Mode
1	Automatic
2	Closed
3	Purge

---

#### 40036: Flow unit index

The value indicates the selected flow unit on the instrument. The table shows the available values:

Value	Unit
1	Sc/s
2	Sc/m
3	Sc/h
4	Ncc/s
5	Ncc/m
6	Ncc/h
7	SCF/s
8	SCF/m
9	SCF/h
10	NM3/s
11	NM3/m
12	NM3/h
13	SM3/s
14	SM3/m
15	SM3/h
16	Sl/s
17	Sl/m
18	Sl/h
19	NI/s
20	NI/m
21	NI/h
22	g/s
23	g/m
24	g/h
25	Kg/s
26	Kg/m
27	Kg/h
28	Lb/s
29	Lb/m
30	Lb/h

---

#### 40037: Password

Current set password in the instrument. This password doesn't affect the Compod™.

---

#### 40038: Input set point index

Value indicates the source for the set point. The table shows the available values:

Value	Source
1	RS232
2	0 – 5 volts
3	0 – 10 volts
4	1 – 5 volts
5	4 – 20 mA
6	0 – 20 mA (Smart-Trak® 2 or higher)



**SELECT RS232 AS SOURCE WHEN THE SET POINT NEEDS TO BE CONTROLLED THROUGH THE NETWORK.**

---

#### 40039: Analog output index

Analog output index is the value which indicates the current selected analog output of the instrument. The table shows the available values:

Value	Output option
1	0 – 5 Vdc / 4 – 20 mA
2	0 – 10 Vdc / 4 – 20 mA
3	1 – 5 Vdc / 4 – 20 mA
4	0 – 5 Vdc / 0 – 20 mA (Smart-Trak® 2 or higher)
5	0 – 10 Vdc / 0 – 20 mA (Smart-Trak® 2 or higher)
6	1 – 5 Vdc / 0 – 20 mA (Smart-Trak® 2 or higher)

---

#### 40040: Firmware revision

Firmware revision number of the instrument

---

#### 40042: Device type

There are two characters indication the type of instrument attached to the Compod™. The first character (high byte) indicates the version number of the Smart-Trak® (1, 2 or other). The second character (low byte) indicates if a meter 'M' or controller 'C' is attached.

Example: '1C' = Smart-Trak® 1 - controller, '2M' = Smart-Trak® 2 - Meter

---

**40043 - 40046: Serial number**

Serial number of the instrument expressed as an eight character string.

---

**40047 - 40051: Tag**

Tag (or label) string which is set in the Compod™. The tag can only be set in boot loader mode and can be used f.i. to identify the instrument or its location.

---

**40052 – 40059: Gas name 1****40060 – 40067: Gas name 2****40068 – 40075: Gas name 3****40076 – 40083: Gas name 4****40084 – 40091: Gas name 5****40092 – 40099: Gas name 6****40100 – 40107: Gas name 7****40108 – 40115: Gas name 8****40116 – 40123: Gas name 9****40124 – 40131: Gas name 10**

Gas table present in the instrument.

---

**40132: Sensor data**

Sensor data from the instrument (not available on a Smart-Trak®1). The high byte shows the bridge voltage and the low byte shows the bridge current.

---

**40133: Set unit to zero**

Writing the value 0xA5 to this register will set the zero the instrument (not available on the Smart-Trak® 1). See the Smart-Trak® 2 manual for more information.

---

**40134: Reset unit to factory default**

Writing the value 0xA5 to this register will reset all custom settings to factory defaults (not available on the Smart-Trak®1). The zero value and gas span values are cleared.

## SPECIAL MODBUS SET UP REGISTERS

The Modbus settings for the Compod™ can be altered while it is connected to the network. Through special registers it is possible to change the settings. The settings can be changed but will not become active until a special write is performed.

---

### 44100: ID

The ID code as stored in memory is shown. The ID code set through the ID pins on P1 is not shown. Any value between 1 and 255 can be used.

---

### 44101: Baud rate

Value	Baud rate
1	4800
2	9600
3	19K2
4	38K4
5	57K6

---

### 44102: Parity

Value	Parity
1	None
2	Odd
3	Even

---

### 44103: TX delay

The value in this register will tell the Compod™ to wait a number of milliseconds before starting to transmit the reply to the master.

Delay time = value x 1ms

---

### 44104: Reset unit

Writing back the value read from this register will trigger two events:

1. The values entered for the ID code, baud rate, parity and TX delay will be stored in memory (making them permanent)
2. The Compod™ will perform a power-up reset reading the new settings

The new settings are now active. The new settings will not be stored unless the correct value is written to this register. When the settings are changed and a manual reset is performed then the old settings will be used.



## CHAPTER 5: ALARM SYSTEM

The Compod™ has an alarm system which can monitor two registers and generate an alarm when the registers go beyond a predefined level. The alarm can be routed to a digital output.

The alarm system can also monitor the power consumed by the valve in controllers. When the valve reaches maximum power it will generate heat. Under normal working conditions it will be cooled by the flow. When no flow is present and the valve runs on maximum power it will become very hot and can be damaged in the long run. The alarm system can shut the valve down when it runs on maximum power.

### ALARM PRINCIPLE

The alarm principle is based on performing a compare on a value. When the value becomes bigger (or smaller) than a predefined value an alarm will be triggered.

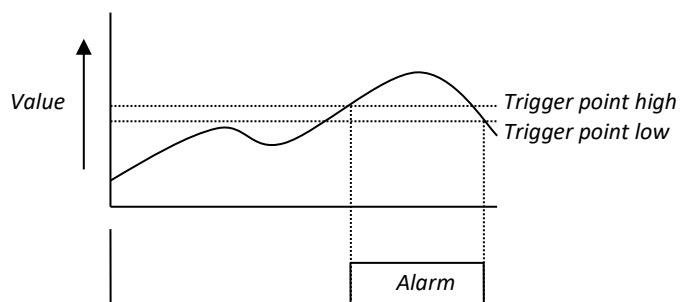

*(Trigger polarity set to higher)*

When the value becomes higher than the trigger point (high) the alarm will be set. When the value drops below the low trigger point the alarm condition is cleared.

### ALARM CONTROL

There are six registers which control the alarm system. There is a control register in which the behavior of the system is defined. A status register gives an overview of the alarm status. Each alarm channel has its own trigger level register.

### ALARM CONTROL REGISTER

The alarm control register (40029) sets the behavior of the two alarm channels and some other alarms.

Overview:

Bit	Function
	<b>Alarm1</b>
0	Enable alarm (0 = off / 1 = on) <i>When not set the alarm will not function</i>
1	Enable output (0 = off / 1 = on) <i>When set digital output1 will be triggered to reflect the alarm state. Setting this bit will disable the output function.</i>
2	Trigger polarity (0 = lower / 1 = higher) <i>Select if the alarm will be triggered when the actual value is higher or lower than the trigger value (trigger source)</i>
3	Alarm lock mode (0 = disabled / 1 = enabled) <i>When cleared the alarm status bit will be toggled according to the alarm condition. When set the alarm status bit (and possible output) will be locked once an alarm has occurred. Clearing the status bit will clear the alarm state.</i>
	<b>Alarm2</b>
4	Enable alarm (0 = off / 1 = on) <i>When not set the alarm will not function</i>
5	Enable output (0 = off / 1 = on) <i>When set digital output2 will be triggered to reflect the alarm state. Setting this bit will disable the output function.</i>
6	Trigger polarity (0 = lower / 1 = higher) <i>Select if the alarm will be triggered when the actual value is higher or lower than the trigger value (trigger source)</i>
7	Alarm lock mode (0 = disabled / 1 = enabled) <i>When cleared the alarm status bit will be toggled according to the alarm condition. When set the alarm status bit (and possible output) will be locked once an alarm has occurred. Clearing the status bit will clear the alarm state.</i>
	<b>Various</b>
8	Valve power alarm (0 = enabled / 1 = disabled) <i>When enabled the set point will be set to zero after 5 minutes when the valve power stays at 3200 the whole time.</i>
9	Sensor failure alarm (0 = enabled / 1 = disabled) <i>If the sensor malfunctions then an alarm is set (Smart-Trak®2 only!)</i>
	<b>Alarm1 – extra option (overwrites other settings)</b>
10	Set point to zero (0 = disabled / 1 = enabled) – highest priority
11	Valve mode set to close (returns to present valve mode when alarm cleared) (0 = disabled / 1 = enabled)

When the alarm lock mode is enabled then the alarm output will remain active even when the alarm condition has been cleared. The alarm output can only be cleared by writing a zero to the status bit in the alarm status register.

The trigger polarity bit determines if an alarm is raised when the monitored value is higher or lower than the trigger value. Setting it to one will raise the alarm when the value becomes higher than the trigger value.



**ENABLING THE DIGITAL OUTPUT WILL DISABLE THE DIGITAL DATA OUT REGISTER. WHEN DISABLING THE DIGITAL OUTPUT IN THE ALARM THE OUTPUT WILL BE SET TO THE VALUE PRESENT IN THE DIGITAL DATA OUT REGISTER**

Alarm 1 has two extra options available (bit 10 & 11). The action selected will be executed once an alarm condition is detected.

---

## TRIGGER SOURCE

Each alarm channel has its own trigger source. The source is a Modbus register whose content is monitored. The following table gives an overview of all the registers which can be used:

Modbus register	Description
40001	Actual flow
40003	Set point
40005	Totalizer left side of the decimal point
40007	Totalizer right side of the decimal point
40009	Valve power
40010	Analog channel 1
40011	Analog channel 2
40012	Digital data in
40013	Digital data out
40015	Factory full scale
40017	User full scale
40019	Gas span
40032	Analog input settings
40033	Pulse out control
40034	Gas index
40035	Valve position index
40036	Flow unit control
40037	Password
40038	Input set point index
40039	Analog output index

The register value to be monitored can be entered in one of the two trigger source registers (40030/40031).

---

## TRIGGER POINT (LEVEL)

Enter the trigger point at which the alarm needs to react. The alarm will become active when the trigger value is exceeded (not when equal or smaller). The entered value will be converted to a data type belonging to the trigger source.

---

## ALARM STATUS REGISTER

The alarm status register will indicate the actual status of the alarm.

Bit	Status
0	Alarm 1 ( 0 = no alarm, 1 = alarm)
1	Alarm 2 ( 0 = no alarm, 1 = alarm)
2	Valve power ( 0 = no alarm, 1 = alarm)
3	Sensor failure – ST2 only ( 0 = no alarm, 1 = alarm)

In lock mode the status bit for the alarm can be cleared by setting the bit to zero. The valve power bit is also cleared by writing a zero to it.

The sensor failure bit can't be cleared by making it zero.

## EXAMPLES

---

### FLOW HIGH AND LOW ALARM

Goal:

An alarm needs to be raised when the flow goes outside a fixed range. When the flow becomes too high alarm 1 is triggered and when the flow becomes too low alarm 2 is triggered. When the flow returns within range the alarms are cleared.

The flow range will be between 50 and 180 NLPH. Dead band set to 10 NLPH.

Register settings:

- Trigger source for alarm 1/2 = 40001
- Trigger point high alarm 1 = 180
- Trigger point low alarm 1 = 170
- Trigger point high alarm 2 = 60
- Trigger point low alarm 2 = 50
- Trigger polarity alarm 1 = 1
- Trigger polarity alarm 2 = 0
- Alarm 1 & 2 enable = 1

Now when the flow goes below or above the trigger points the alarm status register will show an alarm. If an external indication is needed then the digital outputs can be linked to the alarms (enable output = 1).

---

## SHUT DOWN FLOW THROUGH EXTERNAL PUSH BUTTON

Goal:

When an external push button is pressed the controller should set the flow to zero.

Set up:

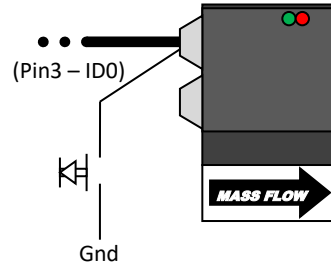

Notice how the ID selection pin is used as a digital input. Any of the four ID pins can be used as an input (when not grounded to set an ID code).

Register settings:

- Trigger source for alarm 1 = 40012
- Trigger point high alarm 1 = 0
- Trigger point low alarm 1 = 0
- Trigger polarity alarm 1 = 1
- Alarm 1 'Set point to zero' = 1 (bit 10 in the alarm control register)

Now when the button is pressed the set point of the controller will be set to zero.

---

## FILL TANK WITH GAS TO MAINTAIN PRESSURE LEVEL

Goal:

Fill a gas tank to keep the tank at a minimum pressure level.

Set up:

The pressure transducer is connected to COM2 - pin3 (analog input) and COM2 - pin 7 (ground).

The tank has a pressure transducer which gives a signal from 4-20mA which represents a pressure range of 0-10 barg. The analog input will read a raw value. This means that 0 mA will be read as '0' and 20 mA will be read as a value around '1023'. Suppose the pressure should be kept at 8 barg. That would mean that the analog input will indicate a value of  $(8/10)*1023 = 818$

The alarm will trigger when the pressure reaches 8 Barg (818). The alarm will be cleared when the pressure drops to 7 Barg (716).

Register settings:

Trigger source for alarm 1 = 40010

Trigger point high alarm 1 = 818

Trigger point low alarm 1 = 716

Trigger polarity alarm 1 = 1

Analog input settings = 130 (5V reference, channel 1 as current input)

Give a set point to start the flow. The pressure in the tank will start to rise and once it rises above 8 barg (analog input indicating around 819 or higher) the alarm will be triggered closing the valve of the controller. When the pressure drop below 7 barg the alarm will be cleared and the valve of the controller is released. The controller will start the flow again filling the tank.



**TO DETERMINE THE TRIGGER POINT IT IS POSSIBLE TO WATCH THE VALUE OF THE ANALOG CHANNEL WHEN THE DISERED PRESSURE IS REACHED.**

The Compod™ can be fitted with a display which shows information about the unit.



Through the mode button located at the right bottom it is possible to cycle through a number of screens giving information about the unit.

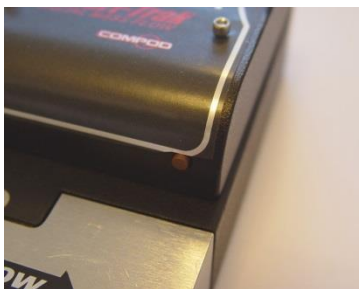

*(Mode button)*

## SCREEN MODES:

With each press of the button the screen will change to display different information.

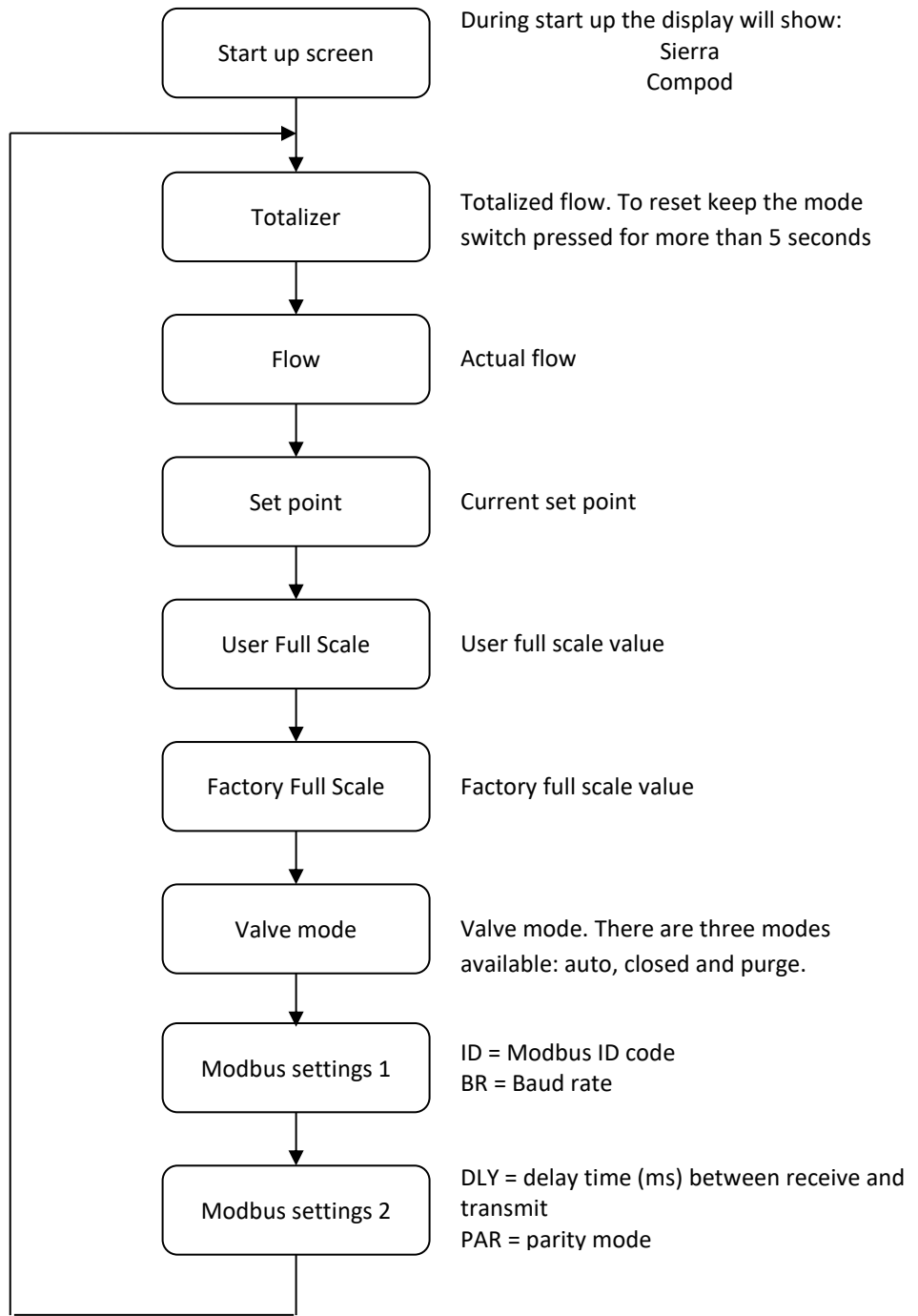



### INTRODUCTION

This chapter describes how the boot loader is used. The boot loader makes it possible to set up applications and download firmware using a simple terminal program and a serial connection.

### GETTING STARTED

In order to use the Bootloader, a PC is needed which is equipped with an RS485 interface or an external converter connected to the RS232 port.

Connect the RS485 interface of the Compod™ to the RS485 interface of the PC. On the PC start a simple terminal program like HyperTerminal.

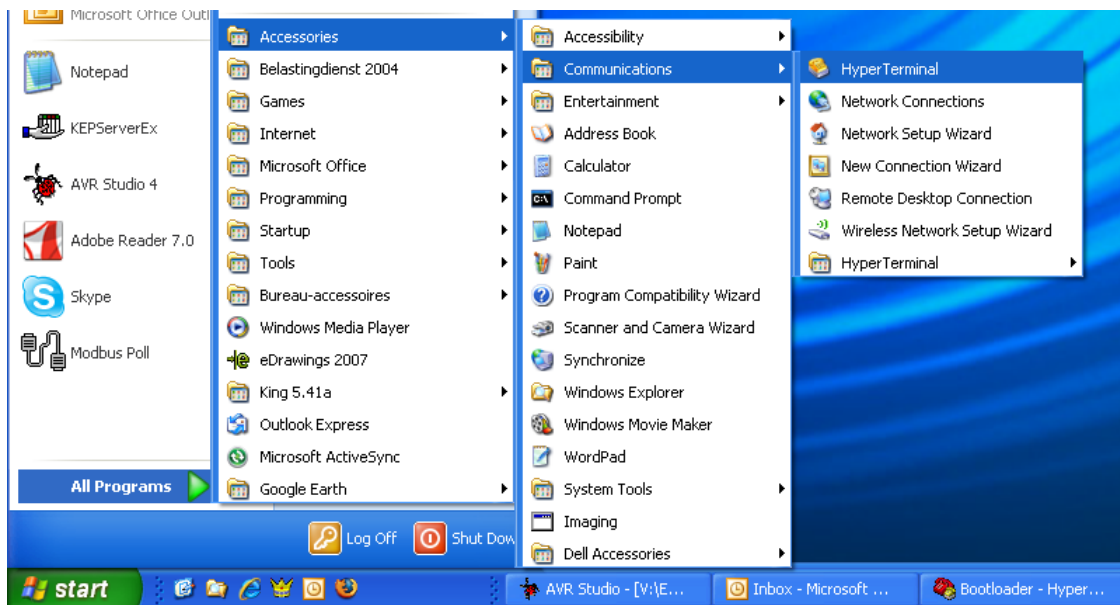

Start HyperTerminal from windows and select the com port to which the RS485 interface is connected. Use the following settings:

Baud rate	: 9600
Number of bits	: 8
Parity	: N
Stop bits	: 1

The boot loader will only be active during the first 2 seconds after a power-up or reset. During power-up (or reset) the green LED will blink twice before executing the application. To enter the boot loader, follow the next steps:

1. Power up the unit

2. In HyperTerminal press the enter key within 2 seconds of power up (any other key will terminate the boot loader and will start the application)

When the boot loader is activated successfully the green LED will stay on. The following menu will be presented on the screen:

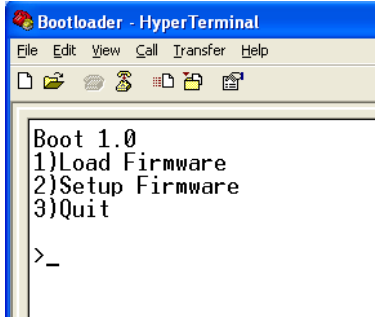

```
Boot 1.0
1)Load Firmware
2)Setup Firmware
3)Quit
>_
```

The version of the boot loader is shown and three options. By pressing the “1”, “2” or “3” key an option is selected. **NOTE: This step is not normally required. Firmware is factory loaded. Proceed to the next step.**

---

### LOAD FIRMWARE (NOT TYPICALLY REQUIRED)

Press “1” to download firmware to the unit. The following screen will be presented:

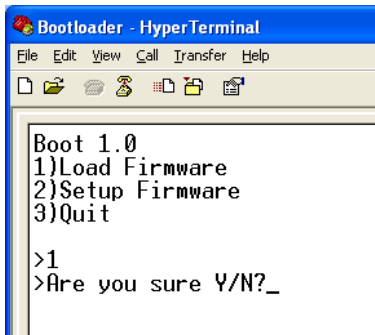

```
Boot 1.0
1)Load Firmware
2)Setup Firmware
3)Quit
>1
>Are you sure Y/N?_
```

A question is presented asking to continue. Press the “Y” or “y” key to continue. Press “N” or “n” to abort. When continuing the following screen will be presented:

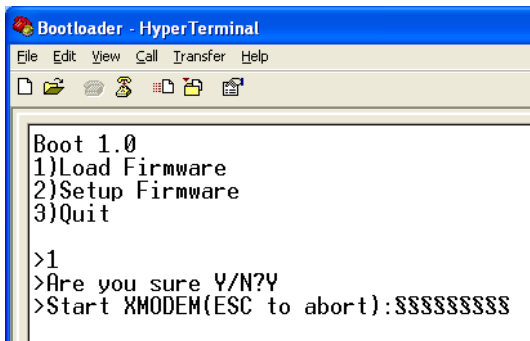

```
Boot 1.0
1)Load Firmware
2)Setup Firmware
3)Quit
>1
>Are you sure Y/N?Y
>Start XMODEM(ESC to abort):$$$$$$$$
```

The screen will start to fill up with the “\$” character indicating that the XMODEM transfer can be started. Press the “ESC” key to abort.

From the “Transfer” menu select “Send file”

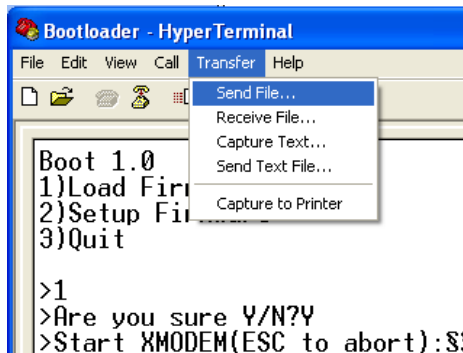

A new screen will be presented asking for the file to be transferred:

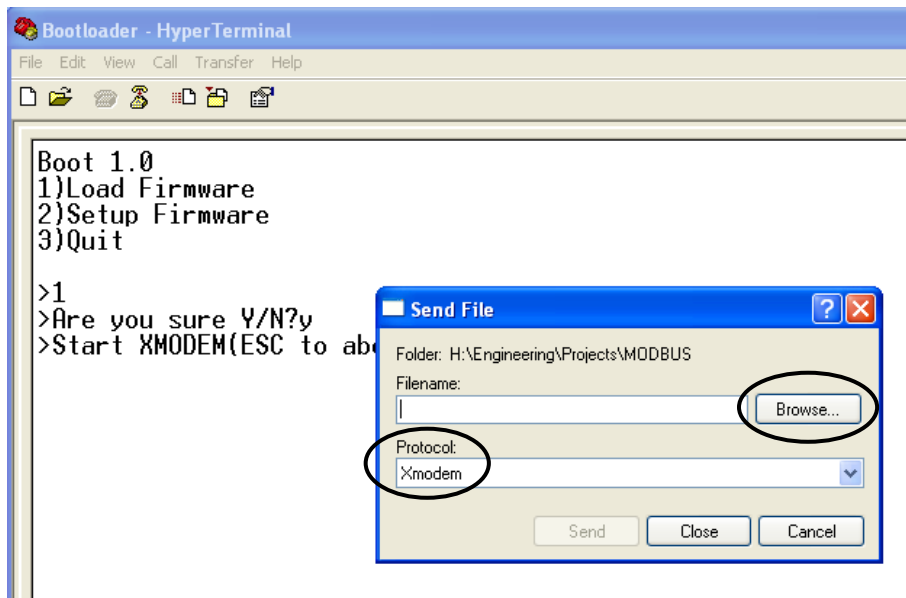

Use the “Browse” button to select the file to download. Only files with the “.hex” extension can be downloaded to the unit. Also make sure that the “Xmodem” protocol is selected. When the file is selected, press the “Send” button. The transfer screen pops up and the file download status can be monitored. During the download the green LED will be off will the red LED will be on.

If the download needs to be cancelled then simple press the “Cancel” button and then press the “Esc” key to return to the boot menu.



**ONCE THE DOWNLOAD HAS STARTED IT ISN'T POSSIBLE TO STOP IT. DOING SO WILL RESULT IN LOSING THE CURRENT APPLICATION.**

The download is now in progress:

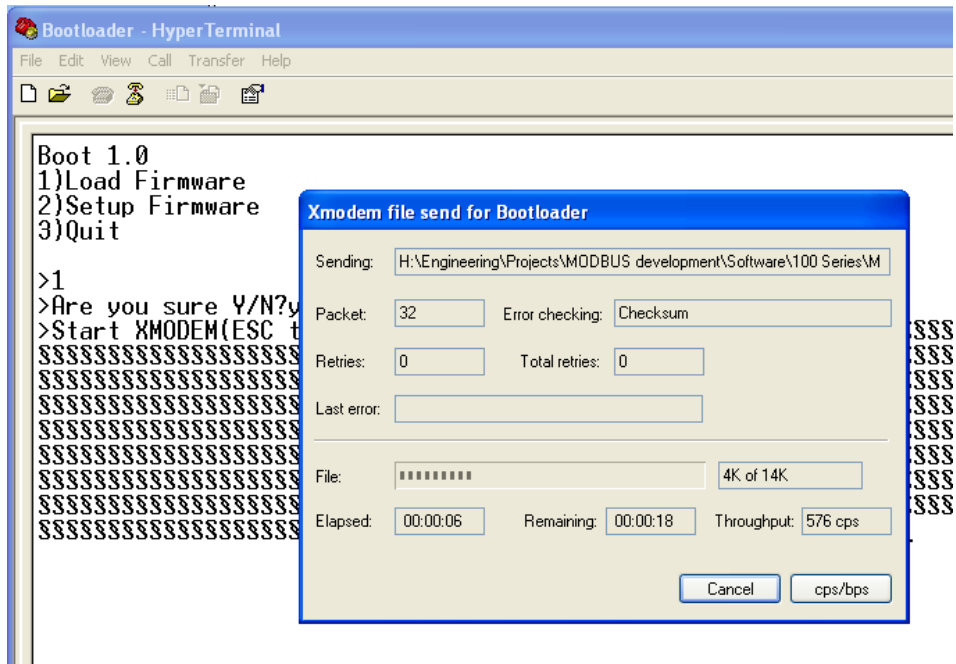

When the download is finished the start-up screen will be shown again presenting three options.

## SETUP FIRMWARE

This option is used to set up the firmware in the unit. When pressing the "2" key the following screen will be presented:

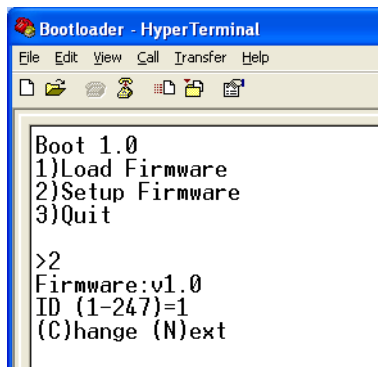

The version of the firmware will be shown followed by the first option which can be set. It will show the current selected value as well which values can be entered.

In this above example, the ID code of the unit can be set between 1-247 and the current setting is 1.

Pressing the “C” or “c” key will prompt for a new value. Enter a new value and press the “Enter” key. The new value will be stored and the next option will be presented (if available). Data which can be entered must match the type presented. So in the above example only numbers can be entered. Characters will be ignored. Also the size of the entry will be limited depending on the maximum size allowed.

When all options have been viewed the default boot menu will be presented again. The options presented will depend on the firmware.



**WHILE ENTERING A NEW VALUE THE “BACKSPACE” KEY CAN BE USED TO ERASE ENTERED VALUES.**



**IT IS ADVISED TO ONLY ENTER VALUES WHICH ARE SHOWN BETWEEN THE BRACKETS. OTHER VALUES MAY BE ENTERED BUT COULD RESULT IN THE UNIT NOT FUNCTIONING CORRECTLY.**

## QUIT

This option will quit the boot loader and will start the application.

## TROUBLE SHOOTING

<b>Problem</b>	<b>Solution</b>
During the firmware transfer the download has halted and nothing is happening anymore (or an error message appears)	Reset the unit and try again. Make sure that only .hex files intended for the unit are selected
When trying the enter data the length is limited. No more data is accepted	For each option the data type and length are predefined. When data isn't accepted anymore than the maximum is reached. Also it's not possible to enter characters when numbers are expected (and vice-versa)
The characters on the screen are all messed up	Check the communication settings. They should be 9600,8,N,1
The unit doesn't enter the boot loader although the enter key is pressed within 2 seconds after start-up	Try swapping the “A” & “B” lines of the RS485 connection and try again

## APPENDIX A: COMPOD™ APPLICATION MANUAL

The Compod™ application is a software tool enabling the user to access and control the various functions of the Compod™. The software gives access to the following:

- Flow data
- Alarm system
- Totalizer
- Pulse output
- Analog inputs
- Smart-Trak® settings
- Digital outputs

## SYSTEM REQUIREMENTS AND SOFTWARE INSTALLATION

Sierra's Compod™ application software is designed to run on your PC compatible Computer with the following minimum system requirements:

- Windows 2000 or better
- 256 MB of RAM, recommended 1 GB; 2 GB of hard disk space
- RS-232 port
- Display resolution of 1024x768 (color screen recommended)

### Windows™ Software Installation

The Smart Interface software and its associated files are provided on CD-ROM or can be downloaded on the web site. The installation process is simple and mostly automated.

1. Locate the Compod™ application setup and run it
2. Follow the on-screen directions for software installation

## GETTING STARTED

Before starting the software, connect the Smart-Trak® equipped with a Compod™ to your computer.

When everything is connected it is time to power up the unit.

## POWER UP

When powered up the green LED on top of the Compod™ enclosure will flash twice. After the flashing the red LED will light up indicating the initialization phase. During this time data is retrieved from the Smart-Trak® and stored into the Compod™ memory. There is no communication possible at this stage.

Once all data is retrieved the red LED goes off and the green LED will start blinking as it receives data from the instrument. The Compod™ is ready to communicate.

If the communication with the instrument is lost for some reason, the Compod™ will try to establish it again. During this phase the interface will not be active.

The red LED will light up every time a network message is received with the correct ID code.



*LED's showing the activities of the Compod*

Start up the Compod application by double clicking on its icon or through the start menu of the PC.

## COMPOD APPLICATION

The application starts with the following screen:

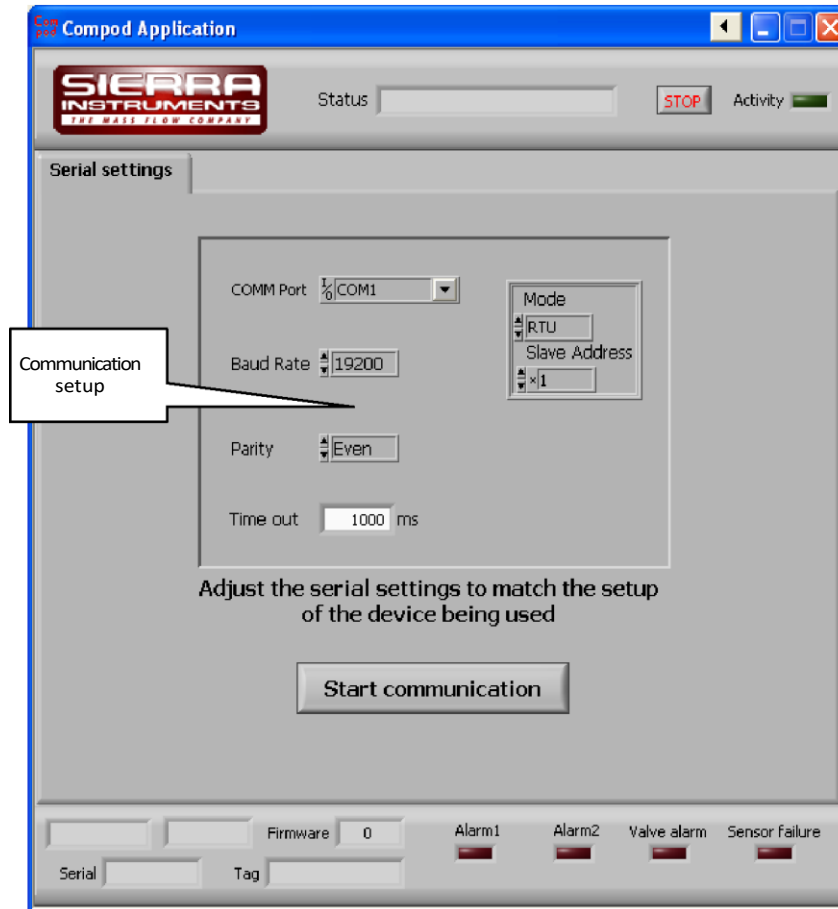

Start by selecting the correct COMM port. Verify the other settings (see user manual for more information about the settings and changing them). When the software is supplied with a special cable and the settings of the Compod™ haven't changed (factory defaults) then the above settings are correct.

Press the "Start communication" button. When all settings are correct and the unit is wired correctly the program will start to collect data from the unit and the activity light should be flashing. On the Compod™ a red light should be flashing to indicate that messages are received.

See the trouble shoot section if nothing happens.

## MAIN PROGRAM

With the communications running the tabs become visible and a selection can be made.



---

## DEVICE TAB

The device tab windows shows all data related to the Smart Trak:

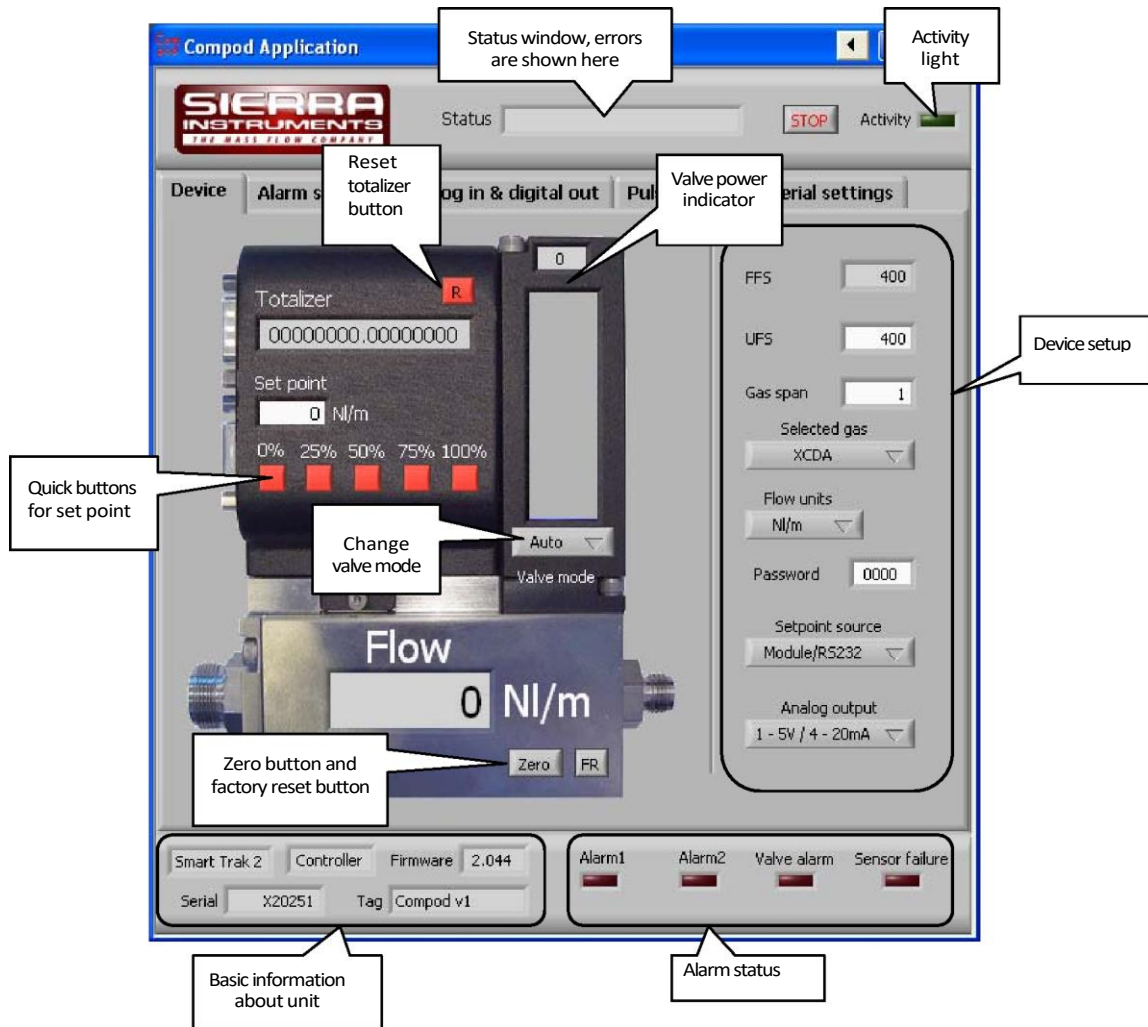

The following functions are not available when the Compod™ is connected to a Smart-Trak® 1:

- Zero unit
- FR (factory reset)
- Gas span of the selected gas
- Sensor failure alarm

When using the Compod™ with a meter the functions to control the flow are disabled.

---

## ALARM SYSTEM TAB

The alarm tab controls the alarm system. Settings can be changed here. When changing a setting the “Write settings” button will start to flash yellow. Until this button is pressed no settings will be stored into memory of the Compod™. To prevent accidental alarms it is advised to change all the settings while the alarm is disabled. Once all the settings have been changed and stored, enable the alarm.

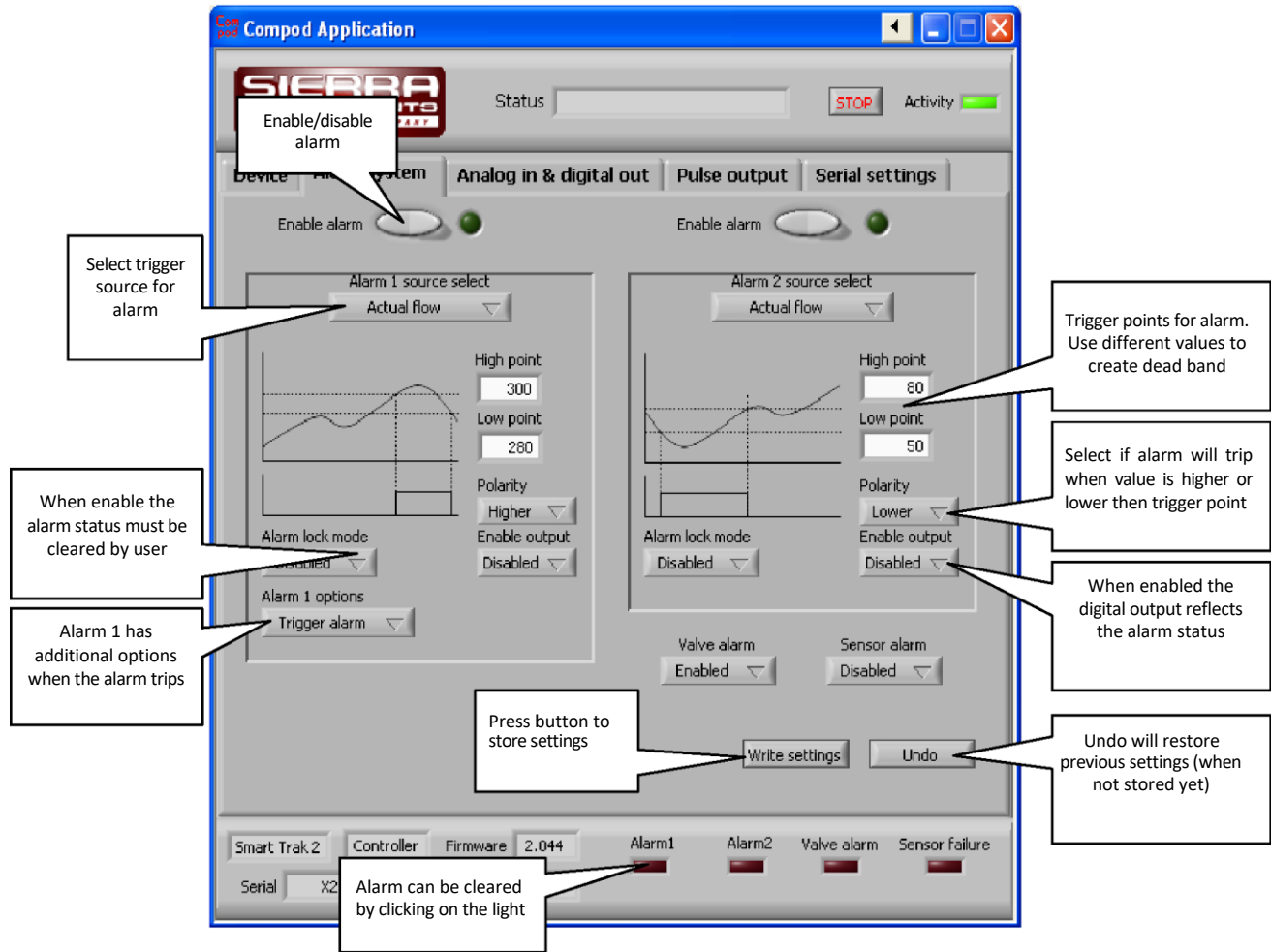

Alarm 1 has been configured as a high flow alarm. The alarm will be activated when the flow becomes bigger the 300 NI/m. A dead band has been created of 20 NI/m by setting the low point to 280.

Alarm 2 has been configured as a low flow alarm. The alarm will be activated when the flow becomes lower the 50 NI/m. A dead band has been created of 30 NI/m by setting the low point to 80.

When setting the high and low point the same the alarm will trip when the flow becomes higher than 300 NI/m and be deactivated when the flow goes below 300. Due keep in mind that oscillation may occur when the flow is around 300 NI/m.

To activate the alarm the “enable alarm” button must be pressed. The alarm will be active for as long as the alarm condition is true. Clearing the alarm while the condition is true will immediately trigger the alarm.

More information about the alarm system can be found in the user manual.

## ANALOG & DIGITAL OUT TAB

The analog input channels and digital outputs are controlled in this tab. The maximum range of the analog to digital converter is 0.1023.

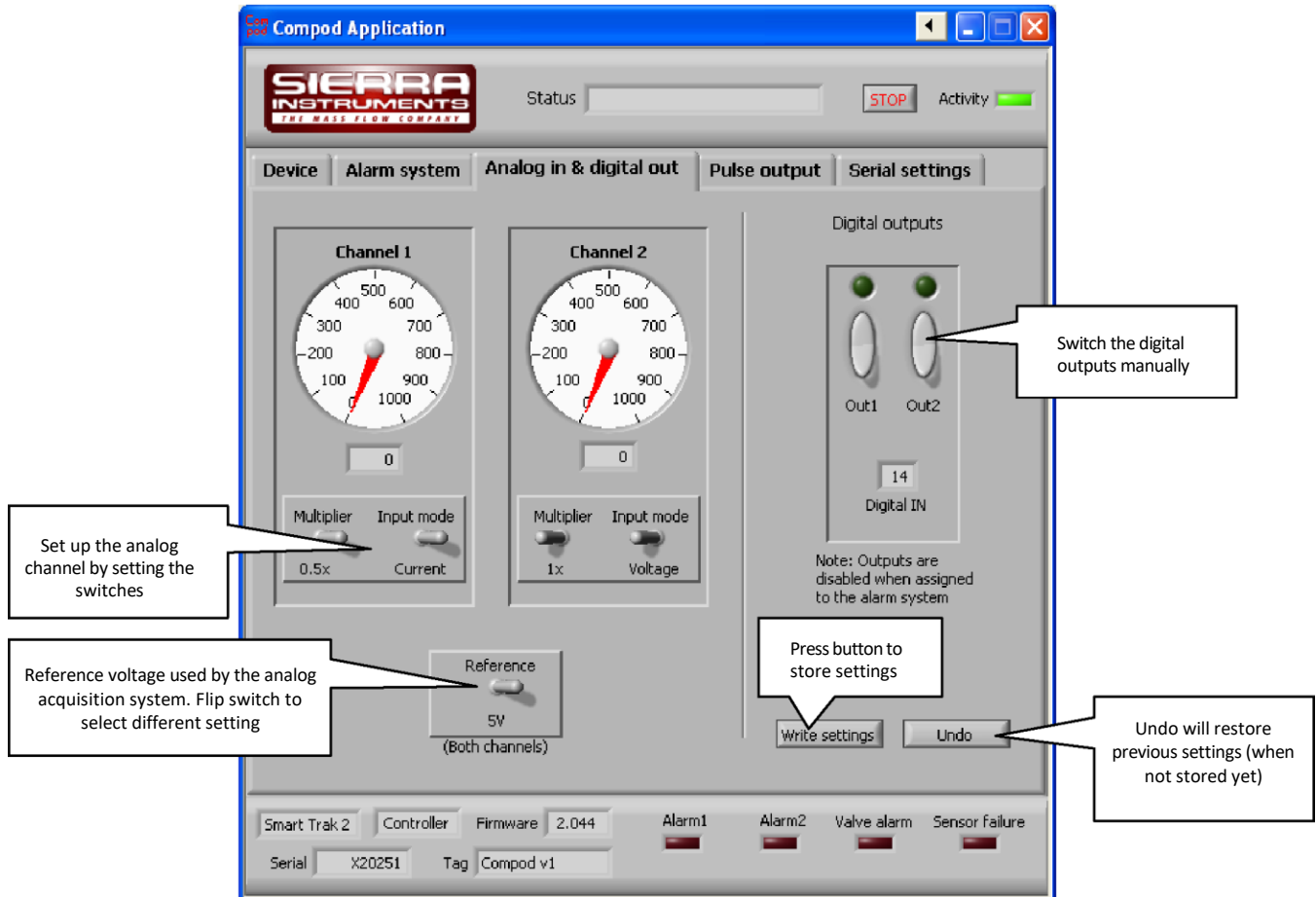

The table below gives an overview of the settings and the input ranges for the analog channels:

Multiplier	Input mode	Reference	Input range
1X	Voltage	2.56V	0.25V
0.5X	Voltage	2.56V	0.5V
1X	Voltage	5V	0.5V
0.5X	Voltage	5V	0.10V
1X	Current	2.56V	0.10mA
0.5X	Current	2.56V	0.20mA
1X	Current	5V	0.20mA
0.5X	Current	5V	0.40mA

Using a lower reference will increase the resolution for small signals.

## PULSE OUTPUT TAB

The pulse output is linked to analog channel 2. When the pulse output is enabled analog channel 2 will be disabled.

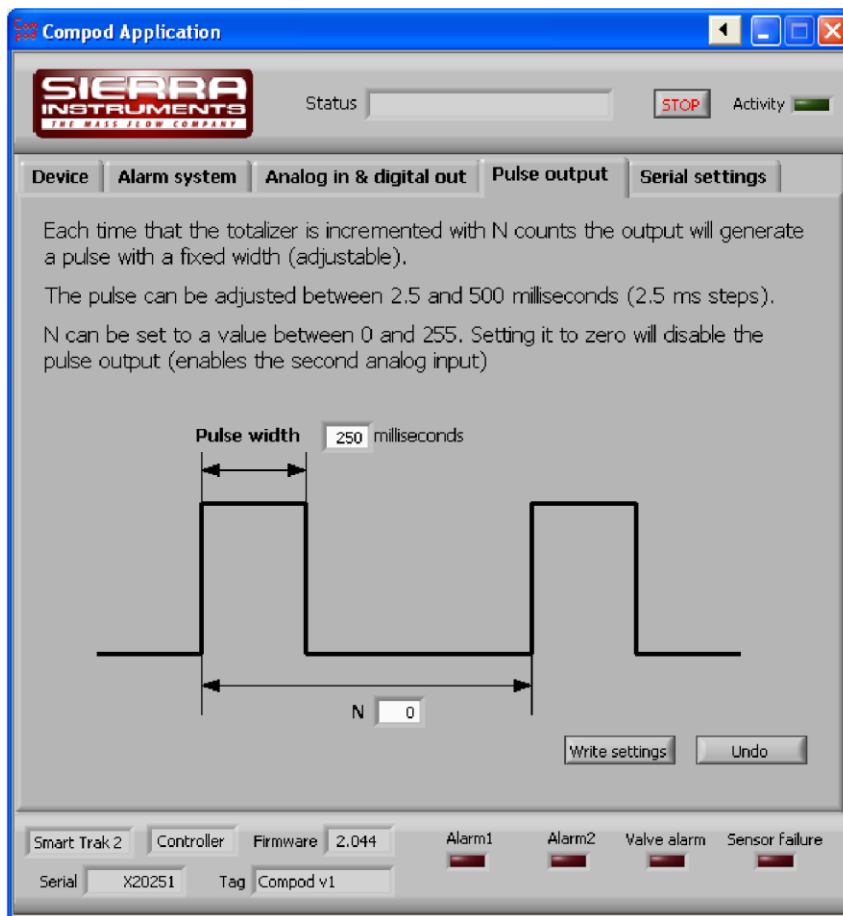

### **LIMITED WARRANTY POLICY- REGISTER ONLINE**

All Sierra products are warranted to be free from defects in material and workmanship and will be repaired or replaced at no charge to Buyer, provided return or rejection of product is made within a reasonable period but no longer than one (1) year for calibration and non-calibration defects, from date of delivery. To assure warranty service, customers must register their products online on Sierra's website. Online registration of all of your Sierra products is required for our warranty process. Register now at [www.sierrainstruments.com/register](http://www.sierrainstruments.com/register). Learn more about Sierra's warranty policy at [www.sierrainstruments.com/warranty](http://www.sierrainstruments.com/warranty).