

RedySmart® Digital Communication for MEMS Thermal Mass Flow Meters & Controllers

RedySmart® Mass Flow Meters (GSM)
RedSmart® Mass Flow Controllers (GSC)
RedySmart® Pressure Controllers (GSP)
RedySmart® Back Pressure Controllers (GSB)

Instruction Manual



Part Number: IM-RedySmart
V2. smart_digi_com_E1_5



Global Support Locations: We are here to help!

CORPORATE HEADQUARTERS

5 Harris Court, Building L Monterey, CA 93940
Phone (831) 373-0200 (800) 866-0200 Fax (831) 373-4402
info@sierrainstruments.com
www.sierrainstruments.com

EUROPE HEADQUARTERS

Bijlmansweid 2 1934RE Egmond aan den Hoef
The Netherlands
Phone +31 72 5071400 Fax +31 72 5071401
sales@sierrainstruments.nl

ASIA HEADQUARTERS

Second Floor Building 5, Senpu Industrial Park
25 Hangdu Road Hangtuo Town
Pu Dong New District, Shanghai, P.R. China
Postal Code 201316
Phone: + 8621 5879 8521 Fax: +8621 5879 8586
orders@sierra-asia.com

For Global Service Centers, go to <http://www.sierrainstruments.com/facilities.html>

Important Customer Notice- Oxygen Service

Sierra Instruments, Inc. is not liable for any damage or personal injury, whatsoever, resulting from the use of Sierra Instruments standard mass flow meters for oxygen gas. You are responsible for determining if this mass flow meter is appropriate for your oxygen application. You are responsible for cleaning the mass flow meter to the degree required for your oxygen flow application.

© Copyright 2020 and Liability Disclaimer

All rights reserved. No part of this publication may be copied or distributed, transmitted, transcribed, stored in a retrieval system, or translated into any human or computer language, in any form or by any means, electronic, mechanical, manual, or otherwise, or disclosed to third parties without the express written permission of Sierra Instruments.



The content of this manual is provided for information only and may be altered without prior notice. Sierra Instruments assumes no responsibility or liability for any errors or inaccuracies in this manual. For the latest information on our products, visit our website www.sierrainstruments.com

TRADEMARKS

RedySmart® and Redy® are registered trademarks of Sierra Instruments. Other product and company names listed in this manual are trademarks or trade names of their respective manufacturers.

Warnings and Cautions

“Warning,” “Caution,” and “Note” statements are used throughout this manual to draw your attention to important information.

Symbol Key		
Symbol	Symbol Meaning	Description
	Warning	“Warning” statements appear with information that is important to protect people and equipment from damage. Pay very close attention to all warnings that apply to your application. Failure to comply with these instructions may damage the meter and cause personal injury.
	Caution	“Caution” indicates that failure to comply with stated instructions may result in damage or faulty operation of the meter.
	Note	“Note” indicates that ignoring the relevant requirements or precautions may result in flow meter damage or malfunction.



Warning! Do not remove the black cover- it prevents damage to the system.

Warning! Removing the cover voids the warranty.

Warning! There are no serviceable parts under the cover.

Warning! Repairs must be performed by a qualified Sierra personnel.

Warning! Connect the device to a protective ground conductor (earth).

Warning! The device must be grounded. The supply voltage is 18-30 VDC (typically ± 50 mV).

Warning! Due to our policy of ongoing product development, we reserve the right to change the information in this manual without notice.

RedySmart® Series Digital Communication Instruction Manual

Part II: Digital Communication

This manual is for RedySmart Series models:

- RedySmart Meter (GSM)
- RedySmart Controller (GSC)
- RedySmart Pressure Controller (GSP)
- RedySmart Back Pressure Controller (GSB)

This manual is valid for instruments with a serial number starting from 110 000.

Receipt of System Components

When receiving a Sierra mass flow meter, carefully check the outside packing carton for damage incurred in shipment. If the carton is damaged, notify the local carrier and submit a report to the factory or distributor. Remove the packing slip and check that all ordered components are present. Make sure any spare parts or accessories are not discarded with the packing material. Do not return any equipment to the factory without first contacting Sierra Customer Service.

Technical Assistance

If you encounter a problem with your flow meter, review the configuration information for each step of the installation, operation, and setup procedures. Verify that your settings and adjustments are consistent with factory recommendations. Installation and troubleshooting information can be found in this manual. See Chapter 1 and 3 for installation and Chapter 7 for troubleshooting.

If the problem persists after following the troubleshooting procedures outlined in the RedySmart product manual, contact Sierra Instruments by fax or by E-mail (see inside front cover). For urgent phone support you may call (800) 866-0200 or (831) 373-0200 between 8:00 a.m. and 5:00 p.m. PST. In Europe, contact Sierra Instruments Europe at +31 20 6145810. In the Asia-Pacific region, contact Sierra Instruments Asia at +86-21-58798521. When contacting Technical Support, make sure to include this information:

- The flow range, serial number, and Sierra order number (all marked on the meter nameplate)
- The software version (visible at start up)
- The problem you are encountering, and any corrective action taken
- Application information (gas, pressure, temperature and piping configuration)

Recycling



Note the



Content

Content	5
1. Digital Communication Modbus	6
1.10 Design of the Modbus RTU Interface	6
1.11 Data Structure	10
1.12 LUT-Data	11
1.13 PID-Data	12
1.14 Parameter Overview	12
1.15 Detailed Explanation	16
1.16 Different Memories	33
1.17 Controller characteristic	33
1.18 Controller Setting	34
2. Digital Communication ProfiBus	36
2.10 Definition of Address and Data Slot	37
2.11 Register	38
3. Pressure Controller GSP/GSB / Modbus	41
3.10 Number Formats	41
3.11 Parameter Overview	41
3.12 Detailed explanation of individual parameters	42
4. Pressure Controller GSP/GSB / ProfiBus	47
4.10 Register	47

1. Digital Communication Modbus

The digital communication with a RedySmart® mass flow meter or controller offers the following advantages:

- **More information**
Besides the flow values you can read out the parameters like the gas temperature, total flow, alarm status, serial number etc.
- **Access to device functions**
Allowing you to adapt the controller behavior and various settings.
- **Plug and Play**
With the cable modules and the free RedySmart Smart Interface Portal (SIP) software, the instruments can directly be connected to PC (USB) and are ready for use.

1.10 Design of the Modbus RTU Interface

RedySmart mass flow meters and controllers work on a serial communication RS-485 with a protocol Modbus RTU. A 2 or 4 wire connection is possible.

	Important Note To use the function firmware update it is necessary to use a 4-wire connection. The communication in this case will be full-duplex with baud rate up to 57600 Bit/s.
---	---

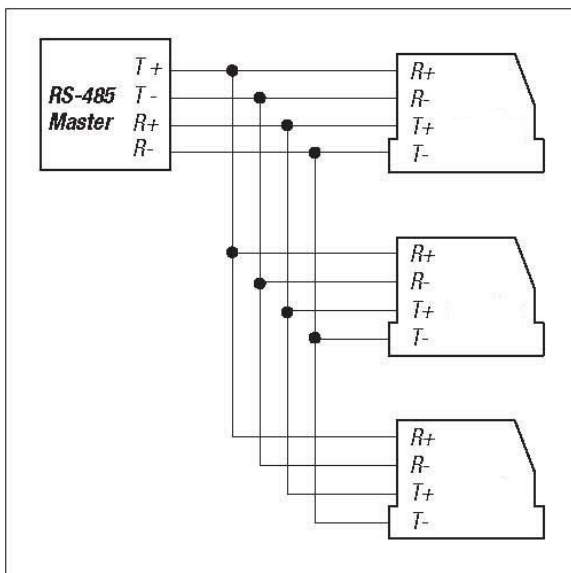

4-wire communication (full duplex)

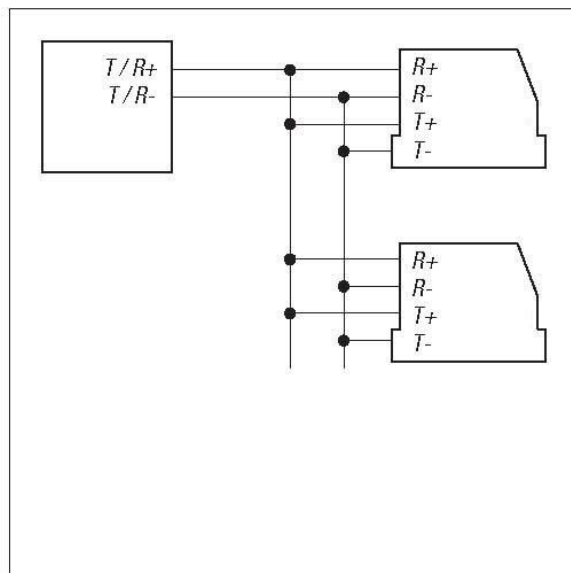

2-wire communication (half duplex)

Each RedySmart must be set to an individual address between 1 and 246 in order to communicate properly with your PC. With the free software RedySmart SIP you can check the bus, read and if necessary change the address of an instrument.

	<p>Important Note</p> <p>When delivered from factory, all instruments have the address No. 247. Please connect and install every single instrument individually one after the other and apply the required address. A bus system does not recognize if two instruments have the same address in the bus.</p> <p>In this case, the RedySmart SIP software shows invalid figures in the list of the instruments.</p>
---	---

Interface Cable

With the interface cable PDM-U, you are able to connect the devices to an USB port.

Communication Parameters

RedySmart works on the following communication parameter:

Communication speed:	9600 Baud
Start bit:	1
Data bits:	8
Stop bits:	2
Parity:	none
input buffer:	300 Bytes

	<p>Important Note</p> <p>There are master systems that are only able to generate 1 stop bit. In this case the second stop bit can be replaced by “mark parity.”</p>
---	--

Modbus RTU

The Modbus protocol is a communication structure for a master-slave communication between intelligent instruments. It is used worldwide and supported by most manufacturers of measurement and control instruments. Originally, it was introduced by MODICON. For further information see www.Modbus.org.

Protocol

A Modbus message from master to slave consists of: Address, command (read or write), data and checksum (CRC). The following picture shows the structure of a complete command:

ADRESS	FUNCTION	DATA	CRC
1 Byte	1 Byte	0..252 Bytes	2 Bytes

The length of a command is limited to 256 bytes.

- **ADRESS**
The Modbus address of a device. Valid addresses are in the range of: 1-247.
A broadcast to all devices goes to address 0 => no answer from the instruments
- **FUNCTION**
Function 03: Read holding register
Function 06: Preset single register
Function 16: Preset multiple registers
- **DATA**
This section holds information about address and data. Data types with several bytes, are transmitted as follows:

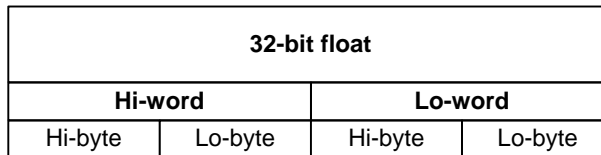
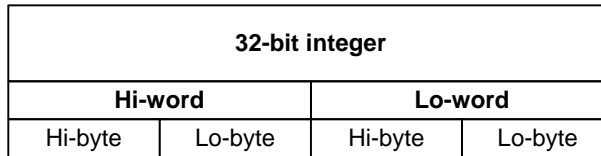
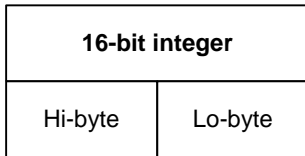

- **CRC**
The chechsum is built over the whole command (excl. CRC).

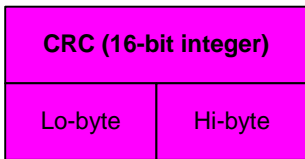

	Important Note: The CRC-bytes are transmitted in lo-hi-order (opposite order!).
---	---

Timing

Between two commands must be a pause of at least 3.5 characters. At a baud rate of 9600, this corresponds with a pause time of 4ms.

Within an instruction the characters may have a maximum distance of 1.5 characters. With a bit rate of 9600 Baud this corresponds to a time of approx. 1.7ms

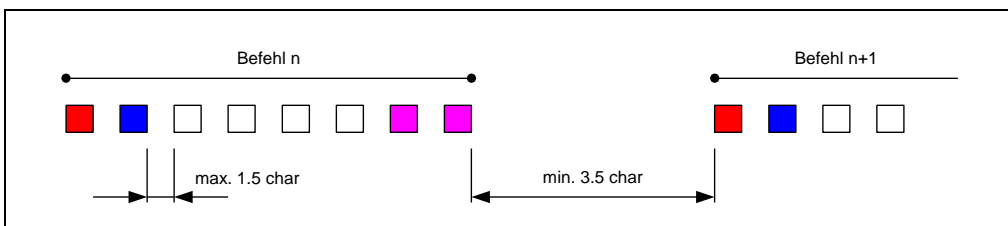

Data Types

Data Type	Format	Description	Length [Bytes]
float32	f32	floating point, according to IEEE-754	4
string8	s8	sequence of symbols, null-terminated	8
string50	s50	sequence of symbols, null-terminated	50
uint8	u8	unsigned integer, 8 bits	1
uint16	u16	unsigned integer, 16 bits	2
uint32	u32	unsigned integer, 32 bits	4

Parameters

Numerous parameters can be read and written via the digital communication. They enable operation (actual and set value) and also device parameterization (gas type, measuring point ID, ...).

Additional parameters are integrated that are only accessible with associated permission and are therefore not documented in detail in this handbook.

The example below illustrates the potential configuration of a parameter.

Name of parameter	register address	write	access level
		read	access level
Description of parameter			
Data format			

1.11 Data Structure

The data structure has the following organization:

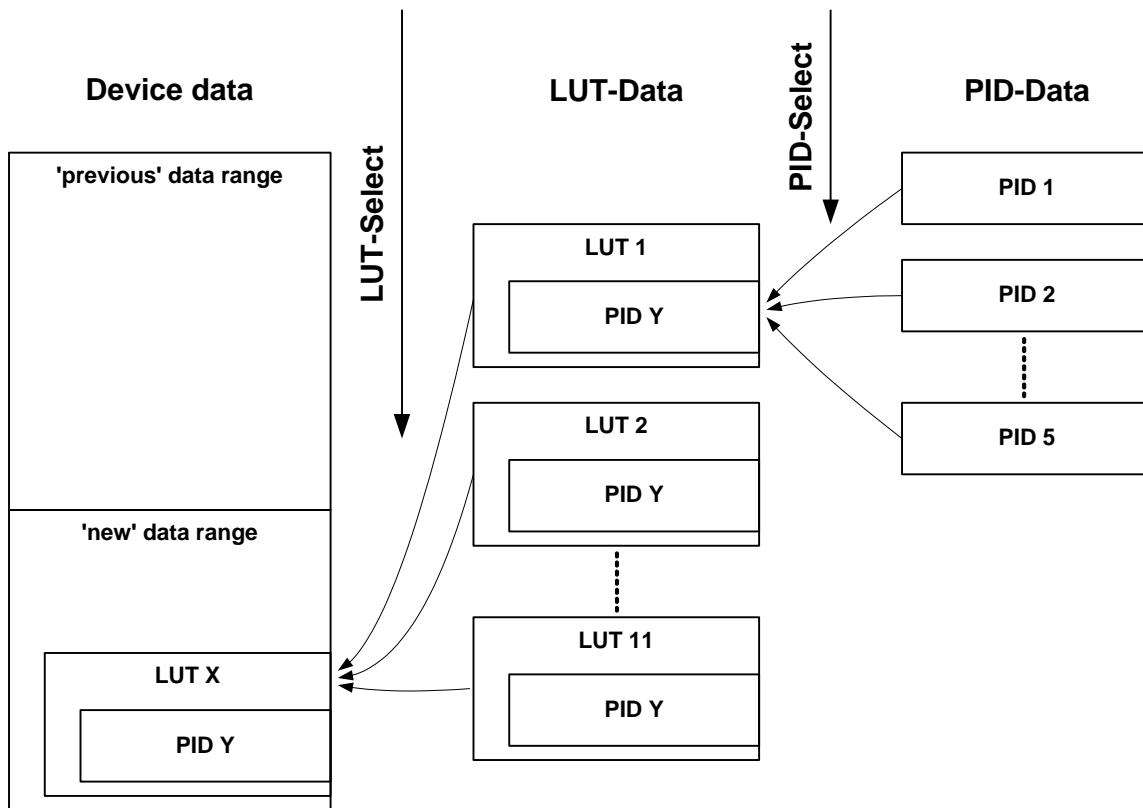

“Previous” Data Area

Compatibility with existing devices was a key issue. Many registers are accessible via identical addresses. Some registers were removed or moved into the “New” data area.

“New” Data Area

This is where new device functions are stored. In addition, the number of selectable gas types was extended to 10. All data that depend on the gas type were moved to the LUT area (e.g. totalizer, sensor amplification, ...)

1.12 LUT-Data

The LUT data area contains all data that depend on the gas type. This is available 11 times on the device, although only areas 2-11 are accessible for the user.

The active gas type is selected via the ‚LUT Select’ register.

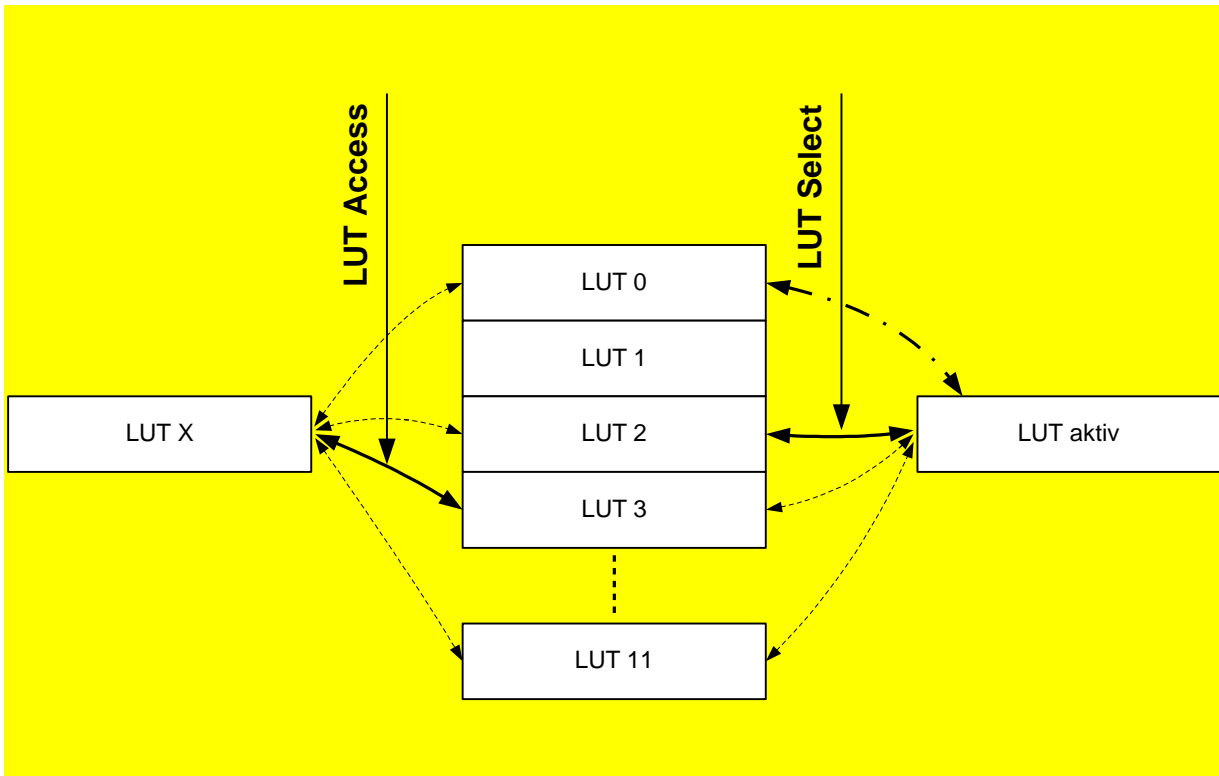

A data pointer can be set via the “LUT Access” register. It enables data to be read from or written to any LUT data area. Data access can be realized independent of the active LUT.



Important Note

If the data pointer “LUT Access” is set to 0, data access is always directed automatically to the active LUT.

1.13 PID-Data

For every gas type (LUT), five different data records are available for control adjustments.

The parameter set is activated via the “PID Select” register.

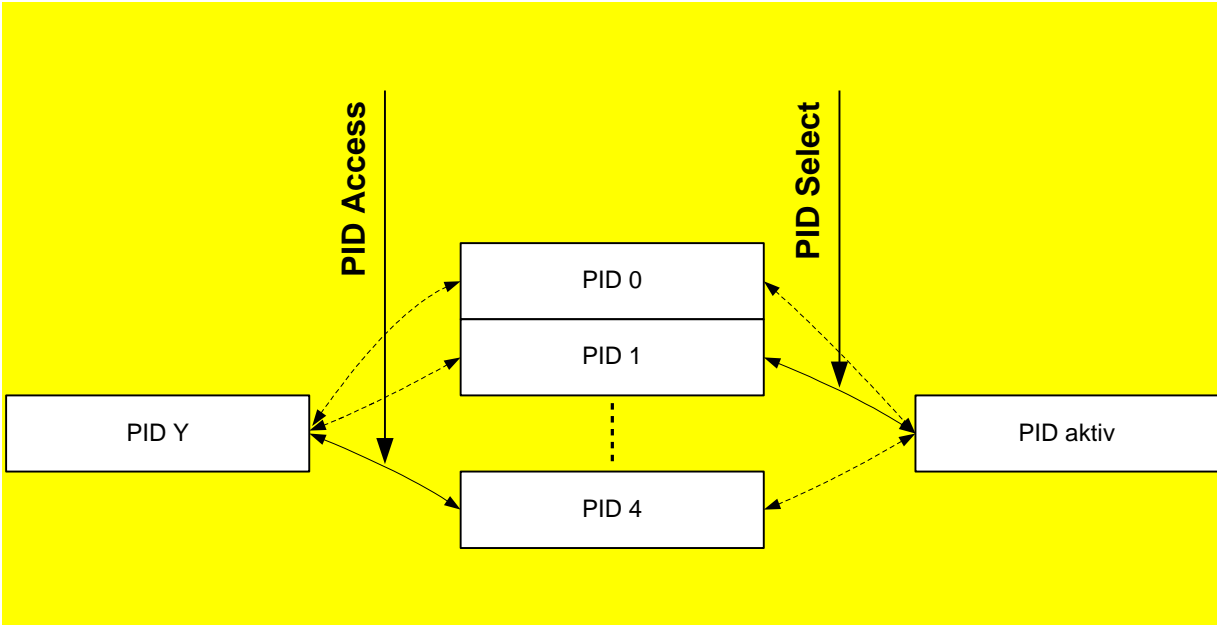

A data pointer can be set via the “PID Access” register. It enables data to be read from or written to any PID data area. Data access can be realized independent of the active PID data record.

1.14 Parameter Overview

The following parameter description is valid for the devices SMART4 or higher.

The description for the devices with Sno < 160000 use the document smart_digit_com V1.4 or 1.3.

Name	Description	Register	Modbus
Gas flow	Measured value of gas flow	0x0000..0x0001	0000
Temperature	Measured value of temperature	0x0002..0x0003	0002
<i>Totaliser</i>	<i>Total gas flow</i>	<i>0x0004..0x0005</i>	0004
Setpoint gas flow	Control setpoint of gas flow	0x0006..0x0007	0006
Analog input	Measured value of analog input	0x0008..0x0009	0008
Valve control signal	Actual value of the valve control	0x000a..0x000b	000a
Alarms	Alarm status	0x000c	000c
Hardware errors	Indicator for possible malfunction	0x000d	000d
Control function	Selection of the controller mode	0x000e	000e
Ramp (V 5.x)	Reducing the control speed	0x000F	000F
Device adress	Modbus device adress	0x0013	0013
Bezeichnung Medium	Zeichenkette des Messmediums	0x001a..0x001d	001a

Name	Description	Register	Modbus
Seriennummer Hardware	Produktionsnummer Elektronik	0x001e..0x001f	001e
Versionsnummer Hardware	Entwicklungsstufe Elektronik	0x0020	0020
Version number software	Development stage of the software (firmware)	0x0021	0021
Save setpoint immediate	Save setpoint value immediate to EEPROM	0x0022	0022
Type code 1	Device type description (part 1)	0x0023..0x0026	0023
Analog output manual	Manual setting of the analog output	0x0028..0x0029	0028
Soft reset	Restarts the device	0x0034	0034
PID Select	Selection of control parameter set	0x0035	0035
Flow-Pressure (V 6.0.12)	function to switch direct from flow to pressure and vice versa	0x0038	0038
Save mode setpoint	Save mode of setpoint value	0x4050	4050
Reverse flow detection	Threshold for detection	0x4052..0x4053	4052
Signal type analog output	Signal type of the analog output	0x4084	4084
Signale type analog input	Signal type of the analog input	0x4085	4085
Delay hardware error	Delay time for the plausibility check at a hardware error	0x4087	4087
LUT Select	Selection of gas table	0x4139	4139
Name of the Metering point	Name only, no function	0x5000	5000
LED Blinkmodus On Off. (V 6.0.12)	The blinking LED Alarm can be switched off, the alarm is still available on the interface	0x5204	5204
Voltage output activ	Switch the analog output signal between current and voltage range	0x5500	5500
Voltage input activ	Switch the analog input signal between current and voltage range	0x5504	5504

Name	Description	Register	Modbus
Customer specific current input low	Low value for customer specific current input signal	0x5505	5505
Customer specific current input high	High value for customer specific current input signal	0x5507	5507
Customer specific voltage input low	Low value for customer specific voltage input signal	0x5509	5509
Customer specific voltage input high	High value for customer specific voltage input signal	0x550B	550B
Customer specific current output low	Low value for customer specific current output	0x550D	550D
Customer specific current output high	High Value for customer specific current output	0x550F	550F
Customer specific voltage output low	Low value for customer specific voltage output	0x5511	5511
Customer specific voltage output high	High value for customer specific voltage output	0x5513	5513
PID Access	Data access pointer to control parameter set	0x5FF7	5FF7
LUT Access	Data access pointer to gas table	0x5FFF	5FFF
LUT ID	Identifier gas table	0x6000..0x6001	6000
Measuring range	Calibrated measuring range (flow)	0x6020..0x6021	6020
Name of fluid (long)	Name of the measured gas (long name)	0x6022..0x603A	6022
Name of fluid	Name of the measured gas	0x6042..0x6045	6042
Measuring unit	Engineering unit of measured value	0x6046..0x6049	6046
Gain	Gain of sensor	0x6120	6120
Heat power	Heat power of sensor	0x6121	6121
Dynamic	Dynamic of measuring range	0x6122	6122
Cutoff	Zero point suppression	0x6123..0x6124	6123
<i>Control parameter K_D</i>	<i>Control parameter differential</i>	<i>0x6202..0x6203</i>	<i>6202</i>
<i>Control parameter K_P</i>	<i>Control parameter differential</i>	<i>0x6204..0x6205</i>	<i>6204</i>
<i>Control parameter K_I</i>	<i>Control parameter integral</i>	<i>0x6206..0x6207</i>	<i>6206</i>
<i>Control parameter N</i>	<i>Control parameter non-linearity valve</i>	<i>0x6208</i>	<i>6208</i>
Totaliser 1	Total gas flow (resettable)	0x6380..0x6381	
Totaliser 2	Total gas flow (not resettable)	0x6382..0x6383	6382
Totaliser scaling factor	Scaling factor of the totalizer	0x6384..0x6385	6384
Totaliser unit	Engineering unit of the totalizer	0x6386..0x6389	6386
Analogfilter at Setpoint	Filter upstreaming to analog output	0x5515	5515

Name	Description	Register	Modbus
ProfiKeepLastValue	Properties when communication fails	0x5943	5943
ProfiSetDefault	Properties when ProfiKeepLastValue	0x5944..0x5945	5944

1.15 Detailed Explanation

<i>Gas flow</i>	0x0000..0x0001	write	no access
		read	user
Measured value gas flow.			
value f32			

<i>Temperature</i>	0x0002..0x0003	write	no access
		read	user
Measured value temperature [°C].			



Important Note

Due to self-heating this temperature may be slightly higher range than the effective gas temperature at the device inlet.

value **f32**

<i>Setpoint gas flow</i>	0x0006..0x0007	write	user
		read	user

Setpoint of the controller.

To activate the setpoint, the controller mode (register 0x000e) has to be in mode 0 (automatic) or in mode 1 (Modbus).

The controller operates only with this setpoint if the power-up alarm (register 0x4040) is not active.

In this case the value is stored in the non-volatile memory and is still present after a power loss. With the power-up alarm activated the setpoint will be lost at a power loss.

value **f32**

<i>Analog input</i>	0x0008..0x0009	write	no access
		read	user

Analog setpoint input for the controller. Manufacturer configuration as voltage [V] or current [mA]. The converted input value is always loaded into the register, whether the controller works in analog or digital mode.

value **f32**

<i>Valve control signal</i>	0x000a..0x000b	write	user
		read	user
<p>Contains the actual control value for the valve whether the control value is generated from the controller (automatic mode) or manually set via Modbus. If the register control mode (0x000e) is defined as mode 10 the control value is immediately loaded into the register. In any other modes the value is stored in a buffer and becomes active when control mode 10 has been activated. It is possible to adjust directly the position of the control valve [0...100%].</p>			
value f32			

<i>Alarms</i>	0x000c	write	no access										
		read	user										
<p>Indicates the alarm messages in a bit map. The bit pattern depends on the status of the instrument and the detected alarms. If an alarm condition is no longer valid the corresponding bit is automatically erased.</p>													
value u16 (bits 15...0)													
<table border="1"> <thead> <tr> <th><i>Bit #</i></th> <th><i>Description</i></th> </tr> </thead> <tbody> <tr> <td>0</td> <td>Indicates a negative flow (flow value < 0)</td> </tr> <tr> <td>1</td> <td>Indicates a negative flow exceeding the backflow setpoint. The bit remains set until a positive flow is detected.</td> </tr> <tr> <td>2..14</td> <td>not used</td> </tr> <tr> <td>15</td> <td>Indicates a hardware error (register 0x000d). This bit is therefore an OR-function of all hardware errors.</td> </tr> </tbody> </table>				<i>Bit #</i>	<i>Description</i>	0	Indicates a negative flow (flow value < 0)	1	Indicates a negative flow exceeding the backflow setpoint. The bit remains set until a positive flow is detected.	2..14	not used	15	Indicates a hardware error (register 0x000d). This bit is therefore an OR-function of all hardware errors.
<i>Bit #</i>	<i>Description</i>												
0	Indicates a negative flow (flow value < 0)												
1	Indicates a negative flow exceeding the backflow setpoint. The bit remains set until a positive flow is detected.												
2..14	not used												
15	Indicates a hardware error (register 0x000d). This bit is therefore an OR-function of all hardware errors.												

<i>Hardware errors</i>	0x000d	write	no access
		read	user
<p>Indicates eventual malfunctions during operation of the instrument. This Information persists even the problem has been solved and has to be reset with the parameter 'Reset hardware error' (0x404f).</p>			
<p>All alarm messages are reset if the instrument is switched off and activated again at power on if an alarm persists.</p>			

value **u16** (bits 15...0)

The following table explains the individual error bits:

Bit #	Description
0	Power-up alarm If the instrument is switched off with activated Power-up alarm and switched on again, then the active setpoint will be the readjusted power-up setpoint. (see parameter power-up alarm setpoint). This status will only be checked at power-up.
1	Alarm analog setpoint Raised if the analog setpoint is outside the valid range (21.6mA, 10.8V). This alarm is only active if the instrument is a flow controller.
2	Zero point or leakage alarm Raised If at a valve control signal of 0% (Valve electrically closed) a flow is measured. Possible causes are: An incompletely closed valve, internal leakage or a zero drift. This alarm is only active if the instrument is a flow controller.
3	No gas / jammed valve alarm Raised if at a valve control signal of 100% (valve electrically fully open) no gas flow is measured. This alarm is only active if the instrument is a flow controller.
4	No reaction Raised if the valve control signal is raised or lowered and no variation of the gas flow is measured. Possible causes are: Jammed valve, changed pressure conditions or valve too small (after a change of gas). This alarm is only active if the instrument is a flow controller.
5	Sensor communication error Raised if a communication problem occurs between the sensor and the electronic module. In this case the measurements are probably wrong.
6	not used
7	EEPROM access check Raised if access errors to the EEPROM are detected. In this case the correct function of the instrument is no longer guaranteed.
8	not used
9	not used
10	Current input overload Raised if current at analog input exceeds 25mA.
11	The sensor serial number does not match the loaded gas data. The valve is closed, the actual value is set to 0.
12..15	not used

<i>Control function</i>	0x000e	write	user
		read	user

Selection of the controller mode and the source of the setpoint.

Value u16

<i>Value</i>	<i>Description</i>
0	<u>Automatic setpoint selection</u> The source of setpoint is automatically selected, i.e.: As standard the analog setpoint (voltage or current signal) is active. If a digital setpoint is sent (via Modbus) automatically the RedySmart switches to 'Digital mode' and the analog setpoint is disabled.
1	<u>Digital setpoint</u> Activates the digital setpoint via digital communication. (Modbus, ProfiBus)
2	<u>Analog setpoint (standard setting)</u> Selects the analog signal as setpoint source.
10	<u>Direct adjustment of the valve signal</u> Deactivates the automatic control mode. Sets the valve control to the value of register 'valve control signal' (0x000a..0x000b).
20	<u>Setpoint 0%</u> Sets the setpoint to 0%.
21	<u>Setpoint 100%</u> Sets the setpoint to 100%.
22	<u>Valve fully closed</u> Deactivates the automatic control mode. Sets the valve control to 0% (Valve fully closed).
23	<u>Valve fully open</u> Deactivates the automatic control mode. Sets the valve control signal to 100% (Valve fully open).
30	<u>Test mode analog output</u> Deactivates the automatic control mode and sets the valve control to 0%. Forces the analog output signal to the value in the register 'Analog output manual' (0x0028).
31	<u>Test mode DAC</u> Deactivates the automatic control mode and sets the valve control to 0%. Forces the analog output signal to the value in the register 'Analog output DAC' (0x0028).

Ramp	0x000F	write	user
		read	user
Reducing the control speed.			
Controls the changing time that it takes from the current nominal value to a new nominal value			
Wert u16 0: Function disabled 200.. 10000: time in ms			

<i>Device adress</i>	0x0013	write	user
		read	user
Defines the device address with which the instrument can be addressed within a Modbus structure. Up to 247 different addresses can be assigned in a Modbus system.			
Attention: In a system, in which several devices are connected with each other via Modbus, all instruments must have different addresses. Otherwise communication errors occur and the system will no longer function.			
value u16 consists of two u8 u8 (bits15..8) not used (should be forced to zero) u8 (bits7..0) device address.			
standard settings: 247			

<i>Serial number</i>	0x001e..0x001f	write	no access
		read	user
Clear and unique serial number of the electronic part of the measuring instrument (PCB).			
value u32			

<i>Version number hardware</i>	0x0020	write	no access						
		read	user						
Version number of the hardware (PCB).									
<table> <tr> <td>Bit 15..8:</td> <td>type</td> </tr> <tr> <td>Bit 7..4:</td> <td>version</td> </tr> <tr> <td>Bit 3..0:</td> <td>subversion</td> </tr> </table>				Bit 15..8:	type	Bit 7..4:	version	Bit 3..0:	subversion
Bit 15..8:	type								
Bit 7..4:	version								
Bit 3..0:	subversion								
example: 4.0.0									
value u16									

<i>Version number software</i>	0x0021	write	no access
		read	user
Different development stages of the software are documented with unequivocal version numbers.			
Codierung:			
Bit 15..8:	type		
Bit 7..4:	version		
Bit 3..0:	subversion		
example: 4.3.7			
value u16			

<i>Save setpoint immediate</i>	0x0022	write	user
		read	user
The setpoint value is stored in the EEPROM. This can be useful if automatic set value storage is disabled (,set value storage characteristics').			
Remark:			
The function ,Power-up set value' can be used to start the device with a defined set value.			
value u16			
value	meaning		
0	no function		
>0	Save setpoint value immediate to EEPROM		

<i>Type code 1</i>	0x0023..0x0026	write	no access
		read	user
Name of the instrument type / instrument code.			
value s8			

<i>Analog output manual</i>	0x0028..0x0029	write	user
		read	user
This function lets you check the connected evaluation of the of the analog measuring value. It is possible to write and read in this register at all times. The value set in this register is first output via the current interface upon activation (register control mode 0x000e =30).			
value f32			

<i>Soft reset</i>	0x0034	write	user
		read	no access
A software reset of the measuring or control instrument takes place if any chosen value is written in this register.			
Attention			
The soft reset is first performed after the response to this command was returned to the master.			
value u16			

<i>PID Select</i>	0x0035	write	user
		read	user
The controller consists of altogether 5 complete control parameter sets (see the corresponding documentation). Three of these sets were defined by the manufacturer and cannot be changed by the user (so-called manufacturer control parameter sets). Two sets can be changed at wish by the user (so-called user control parameter sets).			
One set is used for the current control. This setting can be saved in EEPROM and is available again with the next activation. This set can be read, changed and re-written via Modbus access. Afterwards, the controller immediately works with the modified set.			
<u>Function of the pre-defined control parameter sets:</u>			
Due to the flow end values, the correspondingly applied control valve and the pressure ratios, these sets receive different values for the parameters P, I, D, F and N. We will discuss the function of the individual parameters later on in this manual. The aim is to provide the controller with the following different properties with the three sets:			
U	Fast response time with the corresponding overshooting (fast response)		
V	Medium response time with a low overshooting tendency.		
W	Slow response time without overshooting (slow response)		

Value u16

<i>Auswahl</i>	<i>Typ</i>
0	User control parameter set 1 (default)
1	User control parameter set 2
2	Manufacturer control parameter set U
3	Manufacturer control parameter set V
4	Manufacturer control parameter set W

<i>Type code 2</i>	0x1004..0x1007	write	no access
		read	user
Name of the instrument type / instrument code.			
value s8			

<i>Power-up alarm</i>	0x4040	write	user						
		read	user						
<p>Activation of the power-up alarm function If the alarm is deactivated, the instrument behaves according to its standard or EEPROM settings after an operational disruption or reset. The following operations are performed in case of an operational disruption or reset if the power-up alarm is activated:</p> <ul style="list-style-type: none"> -The power-up alarm setpoint (register 0x4041 . . 0x4042) is used as the new setpoint. The last 'normal' setpoint is overwritten in this process. -The power-up alarm bit is set to one in the register hardware error (0x000d). <p>However, these operations are only performed when the control mode (register 0x000e) is set to 1 (digital). Otherwise, only the alarm flag is set. In each case, the power-up alarm bit remains on 1 until it is explicitly deleted (see description 'Hardware errors').</p>									
value u16									
<table border="1"> <thead> <tr> <th>Value</th> <th>Description</th> </tr> </thead> <tbody> <tr> <td>0</td> <td>activates the power-up alarm</td> </tr> <tr> <td>1</td> <td>deactivates the power-up alarm</td> </tr> </tbody> </table>				Value	Description	0	activates the power-up alarm	1	deactivates the power-up alarm
Value	Description								
0	activates the power-up alarm								
1	deactivates the power-up alarm								

<i>Power-up alarm Setpoint</i>	0x4041 . . 0x4042	write	user
		read	user
<p>Defines the setpoint, which is to be set automatically after an operational disruption or a reset of the instrument if the power-up alarm was configured accordingly. If this value is changed and the instrument is already in power-up alarm mode, the changed alarm setpoint first becomes effective after the next operational disruption or reset.</p>			
value f32 alarm setpoint between 0 and full scale value.			

<i>Reset hardware errors</i>	0x404f	write	user
		read	user
<p>Resets the alarm states of the instrument that occurred during operation. The meaning of the individual error bits are described in the register hardware errors (0x000d).</p> <p>Error bits cannot be set manually as they are always a consequence of faulty operating states. If you want to reset an error bit in the register hardware error (0x000d), the corresponding bit is set here in this register (0x404f). If a bit remains on zero, the error bit is also not changed.</p>			
Value u16 (bit15..0) whereby each bit stands for a specific error to be deleted			

<i>Save mode setpoint</i>	0x4050	write	user
		read	user
Specifies whether the set value is automatically stored in the E ² PROM.			
The service life of a EEPROM depends on the number of write cycles. The guaranteed number of write cycles is 1 million. If the set value is set every 10 minutes, the resulting service life is 19 years.			
If the set value is set at significantly shorter intervals, automatic storage should be disabled.			
Value u16			
Value	Description		
0	manual save mode		
1	automatic save mode		

<i>Reverse flow detection</i>	0x4052..0x4053	write	user
		read	user
This function allows the detection of negative mass flows. This function is intended for measuring instruments and only makes little sense in control operation. The function has to be enabled by the manufacturer.			
Negative flows are detected and the corresponding alarm flags (0x000C) are set (with and w/o hysteresis).			
Negative flows are detected and signalled with the analog signal output (with hysteresis).			
In this register, you can set an alarm threshold in the range from 0% to 20% of the maximum flow			
Value f32			

<i>Signal type analog output</i>	0x4084	write	user
		read	user
Defines the format and the range for the analog output.			
Im Register (0x5500) wird definiert, ob Spannung oder Strom ausgegeben wird.			
value u16			
The following possible defaults are available:			
value	signal format and range		
0	0..20 mA / 0..5 V		
1	4..20 mA / 1..5 V		
2	4..20 mA / 1..5 V		
3	0..20 mA / 0..10 V		
4	4..20 mA / 2..10 V		
5	user defined (Register 0x550D/0x550F, 0x5511/0x5513)		

<i>Signale type analog input</i>	0x4085	write	user
		read	user
Defines the format and the range for the analog input.			
Value u16			
Register (0x5500) defines the output as voltage or current.			
value	signal format and range		
0	0..20 mA / 0..5 V		
1	4..20 mA / 1..5 V		
2	4..20 mA / 1..5 V		
3	0..20 mA / 0..10 V		
4	4..20 mA / 2..10 V		
5	user defined (Register 0x5505/0x5507, 0x5509/0x550B)		

<i>Delay hardware error</i>	0x4087	write	user
		read	user
Sets the minimum time in seconds during which a plausibility error has to occur constantly in operation before the corresponding error bit is set in the register hardware error (0x000d).			
value u16 input range: 0..600 seconds			

<i>LUT Select</i>	0x4139	write	user
		read	user
Specifies, which gas data set is to be used.			
Up to 11 different calibration data sets can be saved in the instrument. They have to be created by the manufacturer.			
Anmerkung: The first available gas data set is stored in section 2.			
value u8 input range: 2..11 (Default: 2)			

<i>Measuring point</i>	0x5000	write	user
		read	user
Tag name of the measuring point.			
value s50			

<i>Baud rate</i>	0x5200	write	user
		read	user
Selects the baud rate for serial communication over Modbus.			
value u16			
possible baud rates:			
value	baud rate		
0	300		
1	600		
2	1200		
3	2400		
4	4800		
5	9600 (default)		
6	19200		
7	38400		
8	57600		

<i>Voltage output activ</i>	0x5500	write	user
		read	user
Switches the analog output format between current and voltage.			
Register (0x4084) defines the active format and range.			
Value u16			
Possible settings:			
value	function		
0	current output format		
1	voltage output format		

<i>Voltage input activ</i>	0x5504	write	user
		read	user
Switches the analog input format between current and voltage.			
Register (0x4085) defines the active format and range.			
Value u16			
Possible settings:			
value	function		
0	current input format		
1	voltage input format		

<i>Customer specific current input low</i>	0x5505	write	user
		read	user
Defines the lower value for the user defined current input range.			
The value must be between 0 [mA] and the upper Value (0x5507).			
value f32			

<i>Customer specific current input high</i>	0x5507	write	user
		read	user
Defines the higher value for the user defined current input range.			
The value must be between the lower value (0x5505) and 20 [mA].			
value f32			

<i>Customer specific voltage input low</i>	0x5509	write	user
		read	user
Defines the lower value for the user defined voltage input range.			
The value must be between 0 [V] and the upper value (0x550B).			
value f32			

<i>Customer specific voltage input high</i>	0x550B	write	user
		read	user
Defines the higher value for the user defined voltage input range.			
The value must be between the lower value (0x5509) and 10 [V].			
value f32			

<i>Customer specific current output low</i>	0x550D	write	user
		read	user
Defines the lower value for the user defined current output range.			
The value must be between 0 [mA] and the upper value (0x550F).			
value f32			

<i>Customer specific current output high</i>	0x550F	write	user
		read	user
Defines the higher value for the user defined current output range.			
The value must be between the lower value (0x550D) and 20 [mA].			
value f32			

<i>Customer specific voltage output low</i>	0x5511	write	user
		read	user
Defines the lower value for the user defined voltage output range.			
The value must be between 0 [V] and the upper value (0x5513).			
value f32			

<i>Customer specific voltage output high</i>	0x5513	write	user
		read	user
Defines the higher value for the user defined voltage output range.			
The value must be between the lower value (0x5511) and 10 [V].			
value f32			

<i>PID Access</i>	0x5FF7	write	user
		read	user
Sets the data pointer to the required data set for read/write operations.			
The data pointer has no effect on the function of the instrument.			
value u16 input range: 0..11			

<i>LUT Access</i>	0x5FFF	write	user
		read	user
Sets the data pointer to the required data set for read/write operations.			
The data pointer has no effect on the function of the instrument.			
value u8 input range 2..11			

<i>LUT ID</i>	0x6000..0x6001	write	no access
		read	user
Unique identifier of the gas table. This value is a time stamp from lookup calculation.			
value u32			

<i>Measuring range</i>	0x6020..0x6021	write	no access
		read	user
Range of the selected gas data set.			
value f32			

<i>Name of fluid (long)</i>	0x6022..0x603A	write	user
		read	user
Long Name of the selected gas data set.			
value s50			

<i>Name of fluid</i>	0x6042..0x6045	write	no access
		read	user
Name of the selected gas data set.			
value s8			

<i>Measuring unit</i>	0x6046..0x6049	write	no access
		read	user
Measuring unit of the selected gas data set.			
value s8			

<i>Gain</i>	0x6120	write	no access
		read	user
Gain on the sensor.			
value u16			

<i>Heat power</i>	0x6121	write	no access
		read	user
Heat power on the sensor.			
value u16			

<i>Dynamic</i>	0x6122	write	no access
		read	user
Dynamic of the measuring range. The measuring range is limited by the dynamic. The smallest measuring value is calculated by:			
$Value = \frac{Range}{Dynamic}$			
value u16			

<i>Cutoff</i>	0x6123..0x6124	write	user
		read	user
This register can be used to suppress the measured mass flow downwards. If the measured value is smaller than the value set here, the output is zero instead of the measurement reading.			
The measured value is additionally limited through the dynamics of the measuring range.			
value f32 , default 0			

<i>Control parameter K_D</i>	0x6202..0x6203	write	user
		read	user
Differential-part of the PID loop.			
value f32 The value must be in the range of 0..10'000			

<i>Control parameter K_P</i>	0x6204..0x6205	write	user
		read	user
Proportional-part of the PID loop.			
value f32 The value must be in the range of 0..10'000			

<i>Control parameter K_I</i>	0x6206..0x6207	write	user
		read	user
Integral-part of the PID loop.			
value f32 The value must be in the range of 0..10'000			

<i>Control parameter N</i>	0x6208	write	user
		read	user
Non-linear part of the PID loop. This value compensates the bounce of the valve.			
Notification:			
This compensation only takes place with a setpoint value larger than zero.			
value u16			
The value must be in the range of 0..8'000			

<i>Totaliser 1</i>	0x6380 . . . 0x6381	write	user
		read	user
Total amount of gas flow since last reset.			
Any value can be written in this register. The totalizer then starts from this value.			
Notification:			
The totalizer value is stored in the EEPROM every 10 minutes. In the event of a voltage interruption adding up continues from the last stored value.			
value f32			

<i>Totaliser 2 (not resettable)</i>	0x6382 . . . 0x6383	write	no access
		read	user
Total amount of gas flow, not resettable.			
value f32			

<i>Totaliser scaling factor</i>	0x6384 . . . 0x6385	write	no access
		read	user
The totalizer assumes that the measured value unit has a time base of 1/min. The totalizer can be re-scaled to any unit via a scaling factor.			
$M_{Totaliser[y]} = F_{Factor} * M_{Totaliser[x/min]}$			
Legende:			
$M_{Totaliser[y]}$: Added up gas quantity converted via the associated scaling factor			
F_{Factor} : Scaling factor (definition see totalizer sum scaling factor register)			
$M_{Totaliser[x/min]}$: Gas quantity totalizer value relative to time base 1/min			
In this way it is possible to select any unit for the totalizer sum.			
Example:			
The device measures flow with the unit ,ln/min'. With a scaling factor of 1 shows the totalizer shows ,ln'.			
Value f32			
Default 1			

<i>Totaliser unit</i>	0x6386..0x6389	write	no access
		read	user
Unit of the totalizer value.			
value s8			

<i>Analogfilter at Setpoint</i>	0x5515	write	no access
		read	user
An analog filter can be activated upstream to the setpoint. This filter permits to reduce the random noise on the analog interface or to calm down the signals of an external pressure transducer.			
0 < Value < 25			
0 = off			
15 = middle			
25 = strong			
Default: 0			
Value unit 8			

<i>ProfiKeepLastValue</i>	0x5943	write	no access
		read	user
Properties of Profibus when communication fails			
Value: 1 0			
1: The last given setpoint will be applied also after failing of profibus communication.			
0: When communication fails, the setpoint of the register ProfiSetDefault will be applied.			
Default: 0			
Value unit 8			

<i>ProfiSetDefault</i>	0x5944..0x5945	write	no access
		read	user
Properties of Profibus when ProfiKeepLastValue.			
0 <= Setpoint <= 100 %			
1: The last given setpoint will be applied also after failing of profibus communication.			
0: When communication fails, the setpoint of the register ProfiSetDefault will be applied.			
Default: 0 %			
Value unit 8			

1.16 Different Memories

The controller has three different memories respectively data sources.

- EEPROM (configuration data, etc.)
- RAM (measuring values, etc.)
- ROM (fix-coded data, firmware)

Saving Data in non-volatile-memory

Certain register contents are saved in the non-volatile memory (EEPROM). They are written to the memory, if data value changes.

Since the number of write accesses to an EEPROM is limited, continuous writing of values may shorten the lifetime of the EEPROM.

Example:

With a write cycle of 1 s an EEPROM with a typical service life of 1 million write cycles would have an expected lifetime of 11.5 days.



Important Note

The set value is excluded from this rule. The “set value storage characteristics” register (0x4050) can be used to define whether a change in value is stored in the EEPROM.

1.17 Controller characteristic

Controller structure

The controller consists of a linear and a non-linear part. The linear part of the controller consist of the following components:

- Proportional part K_P
- Integral part K_I
- Differential part K_D

The non-linear part is:

- Non-linearity (N)

Valve Characteristics Curve

In its work range, the valve characteristics curve has almost linear characteristics. Here, the valve does not use the entire adjustment value range from 0% to 100%. The operating points P_1 (opening point) and P_2 (max. possible flow) depend on the inlet pressure and the pressure difference across the valve ($dP_a < dP_b$).

Typical valve characteristic

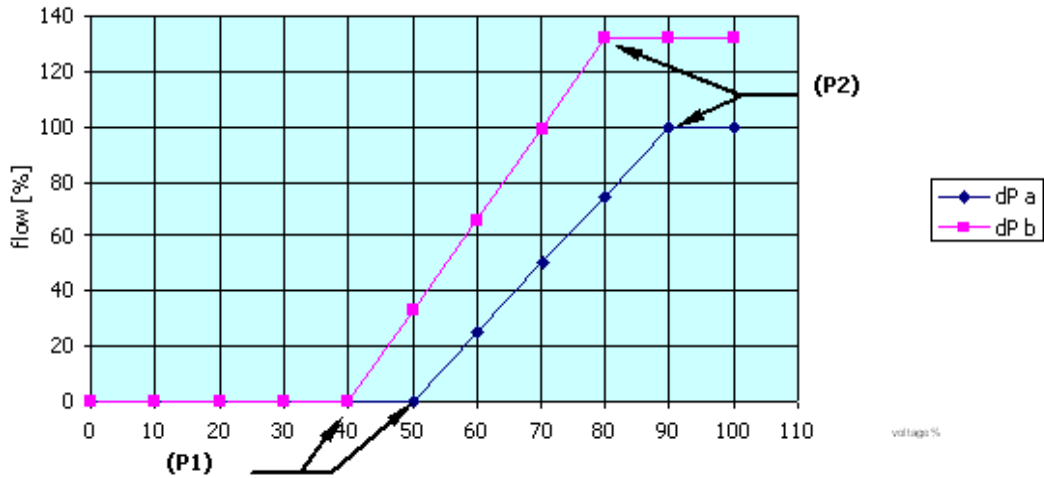

Function of the Individual Parameters

Non-linearity N

The parameter non-linearity N compensates the dead zone in the area 0% to DA%. This compensation only takes place with a setpoint default larger than zero. With setpoint defaults larger than zero, a value generated by N is added to the controlling signal generated by the linear control algorithm. Naturally, the value N may never be larger or equal the value P1.

1.18 Controller Setting

We recommend setting the individual controller parameters as follows:

1. Control parameter N
2. Control parameter K_P
3. Control parameter K_I
4. Control parameter K_D

Setting control parameter N

1. Connect the controller electrically (warm-up time) and establish the operating conditions (pressure ratios) as far as possible.
2. The RedySmart SIP software provides access to control parameter sets A and B.
3. Set the control parameters to the following values: $K_P=0$; $K_I=0$; $K_D=0$; $N=0$
4. Set the set value to 5% of the end value.
5. Increase parameter N in steps of 100 until flow occurs.
6. Set N to 80% of the value found in this way. N remains the same for all sets.

Setting control parameter K_P

1. Set K_P to 3000.
2. Set K_I to 600.
3. Set K_D to 200.

The control characteristics are assessed through different set value variations.

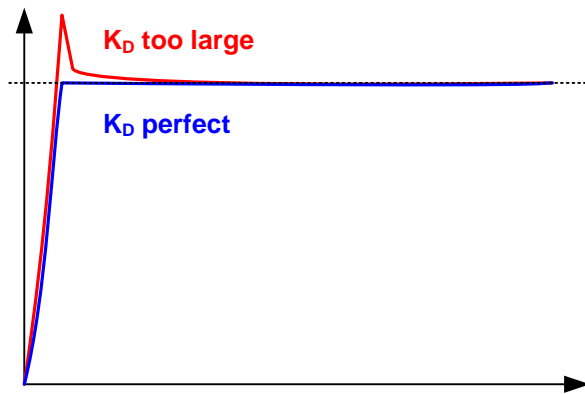
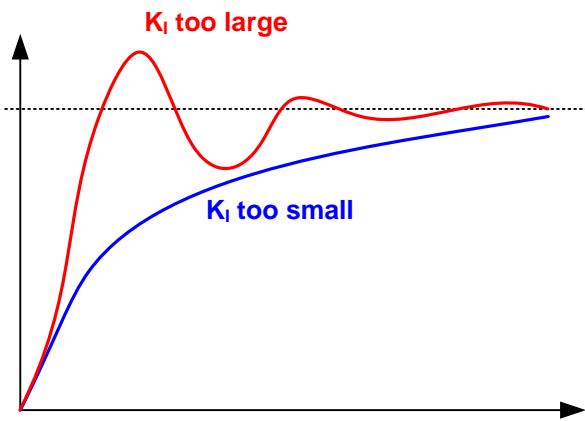

2. Digital Communication ProfiBus

This document describes device data access via ProfiBus communication. The detailed function of the individual registers is described in section 'Digital Communication Modbus'.

Cyclical Communication DP-V0

Information is exchanged between the master and the slaves in a predefined message cycle. The scope of the information is configured in advance (offline) with a software tool. To this end functionality information is required for all devices.



Warnings

Cyclical data are NOT stored in the EEPROM (from firmware 4.3.8). After a power failure, other parameters may be active until cyclical data traffic has been re-established.

Device Master Data File (GSD)

The GSD is the mandatory 'identity card' of a ProfiBus device. It contains the device characteristic data, information about its communication capability, and additional information about diagnostic values, for example.

For cyclical exchange of measurement readings and control variables between field devices and the automation system the GSD is sufficient for device integration.

Acyclical Communication DP-V1

Field devices are becoming increasingly complex and can be configured for different situations. This information is exchanged in parallel with the cyclical communication as required. The data exchange is triggered by the master during runtime.



Important Note

Acyclical data are stored in the EEPROM. A distinction is made between data that are stored with each write access (i) or only in the event of a change (c).

Indexed Addressing

Due to the large number of parameters, different control systems may not be able to address all parameters. Indexed addressing was therefore realized.

These can be activated in RedySmart SIP so that an address slot and a data slot is available. Both are allocated to a slot/index. In order to communicate with the device, the address slot with the required slot/index must be used for write access. The address slot expects a value in format u16. The high-order byte refers to the slot, the low-order byte to the index.

The write or read operation is then carried out in the data slot. The parameter format can be found in the table on page 45.



Important Note

If indexed addressing is activated, only the address and data slot is accessible for acyclical communication.

2.10 Definition of Address and Data Slot

The address and data slots are defined in RedySmart SIP:

The screenshot shows the 'get red-y' software interface. The 'Parameter' tab is active, and the 'Profibus' settings are displayed. The 'Acyclic communication' section has 'Indexed access' checked. The 'Address slot' is set to 19 and the 'Index' to 29. The 'Data slot' is set to 39 and the 'Index' to 49. A table at the bottom shows the following data:

On	Addr.	Serial no.	Type-Code	Gas	Reading	Setpoint	Unit	Temp.	Unit	Total	Unit	Gauge identification
on	247	131703	GSM-B5SA-BN00	Air 5	0,0	----	l ³ /min	28		10,02	l ³	device meter
▲	1	121724	GSP-C9TA-BB26	N2 20	0,0	0	l ³ /min	27,6	°C	1339,01	l ³	pressure controller

The slot can be in the range 0x00 . . 0xFF, the index in range 0x00 . . 0xFE.

Control Systems

The implementation of acyclical communication may differ depending on the control system. The manufacturer of the respective control system should provide associated instructions.

Siemens S7

Acyclical communication is handled via the following modules:

- SFB 52 RDREC read data record
- SFB 53 WRREC write data record

The description can be found in the associated documentation.

2.11 Register

Data types

The register documentation refers to the following data types:

Datentyp	Format	Description	Length [Bytes]
float32	f32	floating point, according to IEEE-754	4
string8	s8	sequence of symbols, null-terminated	8
string50	s50	sequence of symbols, null-terminated	50
uint8	u8	unsigned integer, 8 bits	1
uint16	u16	unsigned integer, 16 bits	2
uint32	u32	unsigned integer, 32 bits	4

Addresses

The following table lists the data that are accessible via ProfiBus.

Mode

Different memory characteristics are defined for write access:

- r read only (parameter can only be read)
- s special (set value is handled separately via register 4050)
- i immediate (value is stored in the EEPROM with each write access)
- c changed (value is stored in the EEPROM whenever there is a change)
- (value is not stored in the EEPROM)

Register			ProfiBus Cyclic		ProfiBus Acyclic			
Description	Address [hex]	Format	Module	Read [hex] Write [hex]	Mode	Slot [hex]	Index [hex]	Length [dez]
Gas flow	0000	f32	Flow Rd ---	43 83 00 00 00 ---	r	00	00	4
Temperature	0002	f32	Temperature Rd ---	43 83 00 00 02 ---	r	00	02	4
Setpoint gas flow	0006	f32	Setpoint Rd Setpoint Wr	43 83 00 00 06 83 83 00 00 06	s	00	06	4
Analog input	0008	f32	Analog Input Rd ---	43 83 00 00 08 ---	r	00	08	4
Valve control signal	000A	f32	PWM Signal Rd PWM Signal Wr	43 83 00 00 0A 83 83 00 00 0A	i	00	0A	4
Alarms	000C	u16	Alarm Info Rd ---	43 81 00 00 0C ---	r	00	0C	2
Hardware errors	000D	u16	HW Error Rd ---	43 81 00 00 0D ---	r	00	0D	2
Control function	000E	u16	Control Mode Rd Control Mode Wr	43 81 00 00 0E 83 81 00 00 0E	c	00	0E	2
Device adress	0013	u16	--- ---	--- ---	i	00	13	2

Register			ProfiBus Cyclic		ProfiBus Acyclic			
Description	Address [hex]	Format	Module	Read [hex] Write [hex]	Mode	Slot [hex]	Index [hex]	Length [dez]
Serial number	001E	u32	SerialNumber Rd ---	43 83 00 00 1E ---	i	00	1E	4
Version number hardware	0020	u16	---	---	r	00	20	2
Version number software	0021	u16	SW Version Rd ---	43 81 00 00 21 ---	r	00	21	2
Save setpoint immediate	0022	u16	---	---	-	00	22	2
Type code 1	0023	s8	DeviceTypeCode1 Rd ---	43 87 00 00 23 ---	i	00	23	8
Analog output manual	0028	f32	---	---	i	00	28	4
Soft reset	0034	u16	---	---	-	00	34	2
PID Select	0035	u16	PID Select Rd PID Select Wr	43 81 00 00 35 83 81 00 00 35	c	00	35	2
Type code 2	1004	s8	DeviceTypeCode2 Rd ---	43 87 00 10 04 ---	i	10	04	8
Power-up alarm	4040	u16	---	---	i	40	40	2
Power-up alarm Setpoint	4041	f32	---	---	i	40	41	4
Reset hardware errors	404F	u16	HW Error Reset Wr	83 81 00 40 4F	-	40	4F	2
Save mode setpoint	4050	u16	---	---	i	40	50	2
Reverse flow detection	4052	f32	---	---	i	40	52	4
Signal type analog output	4084	u16	---	---	i	40	84	2
Signale type analog input	4085	u16	---	---	i	40	85	2
Delay hardware error	4087	u16	---	---	i	40	87	2
LUT Select	4139	u8	Lut Select Rd Lut Select Wr	43 80 00 41 39 83 80 00 41 39	c	41	39	1
Measuring point	5000	s50	Tag Name Rd ---	43 B1 00 50 00 ---	i	50	00	50
Voltage output activ	5500	u16	---	---	i	55	00	2
Voltage input activ	5504	u16	---	---	i	55	04	2
PID Access	5FF7	u16	---	---	c	5F	F7	2
LUT Access	5FFF	u8	Lut Access Rd Lut Access Wr	43 80 00 DF 00 83 80 00 DF 00	c	DF	00	1
LUT ID	6000	u32	---	---	i	60	00	4
Measuring range	6020	f32	Flow Range Rd ---	43 83 00 60 20 ---	i	60	20	4
Name of fluid (long)	6022	s50	Gasname Rd ---	43 B1 00 60 22 ---	i	60	22	50

Register			ProfiBus Cyclic		ProfiBus Acyclic			
Description	Address [hex]	Format	Module	Read [hex] Write [hex]	Mode	Slot [hex]	Index [hex]	Length [dez]
Name of fluid	6042	s8	Gas Rd ---	43 87 00 60 42 ---	i	60	42	8
Measuring unit	6046	s8	FlowUnit Rd ---	43 87 00 60 46 ---	i	60	46	8
Gain	6120	u16	--- ---	--- ---	i	61	20	2
Heat power	6121	u16	--- ---	--- ---	i	61	21	2
Dynamic	6122	u16	--- ---	--- ---	i	61	22	2
Cutoff	6123	f32	--- ---	--- ---	i	61	23	4
Control parameter K_D	6202	f32	--- ---	--- ---	i	62	02	4
Control parameter K_P	6204	f32	--- ---	--- ---	i	62	04	4
Control parameter K_I	6206	f32	--- ---	--- ---	i	62	06	4
Control parameter N	6208	u16	--- ---	--- ---	i	62	08	2
Totaliser 1	6380	f32	Totalisator Rd ---	43 83 00 63 80 ---	i	63	80	4
Totaliser 2	6382	f32	TotalisatorN Rd ---	43 83 00 63 82 ---	i	63	82	4
Totaliser scaling factor	6384	f32	--- ---	--- ---	i	63	84	4
Totaliser unit	6386	s8	TotalisatorUnit Rd ---	43 87 00 63 86 ---	i	63	86	8

3. Pressure Controller GSP/GSB / Modbus

3.10 Number Formats

Data Type	Format	Description	Length [Bytes]
float32		Floating point number according to IEEE-754	
string8		8-character string	
string50		50-character string	
uint8		Unsigned whole number, 8 bits	
uint16		Unsigned whole number, 16 bits	
uint32		Unsigned whole number, 32 bits	

3.11 Parameter Overview

Description	Description	Registers	Modbus
Control mode	Selection / characteristic of the controller	0x000e	000e
Pressure – Flow Control (V 6.0.11)	Easy switch between flow to pressure controller or vice versa	0x0038	0038
Nominal pressure value at power-up (V 6.0.12)		0x4044	4044
Measured value, pressure	Measured value of the gas pressure	0x5f00..0x5f01	5f00
Scaling pressure, min.	Min. value, pressure transformer measurement range	0x5f02..0x5f03	5f02

Scaling pressure, max.	Max. value, pressure transformer measurement range	0x5f04..0x5f05	5f04
Pressure setpoint	Setpoint pre-setting for pressure control	0x5f06..0x5f07	5f06
Pressure unit	Measurement unit, pressure transformer	0x5f08..0x5f0b	5f08
Flow limiting	Flow limiting during pressure control	0x5f0c..0x5f0d	5f0c
Pressure control mode	Selection of setpoint pre-setting	0x5f0e	5f0e
Pressure control operating mode	Selection of function and options	0x5f0f	5f0f
PID Select Pressure	Selection of the control parameter set	0x5f10	5f10
PID Access Pressure	Data pointer control set	0x5f1f	5f1f
<i>Control parameter K_P</i>	<i>Control parameter amplification factor</i>	<i>0x5f20..0x5f21</i>	<i>5f20</i>
<i>Control parameter K_I</i>	<i>Control parameter I-share</i>	<i>0x5f22..0x5f23</i>	<i>5f22</i>
<i>Control parameter K_D</i>	<i>Control parameter D-share</i>	<i>0x5f24..0x5f25</i>	<i>5f24</i>
Tag Name Pressure	Measuring point tag, pressure transformer	0x5f27..0x5f3f	5f27
Analog filter setpoint	Measuring point tag, pressure transformer	0x5515	5515

3.12 Detailed explanation of individual parameters

Control mode	0x000e	Write	User
		Read	User
2 additional options are defined for pressure control. Only these additional functions are described here.			

Value u16

Value	Significance
5	<p><u>Pressure control active</u></p> <p>The pressure is controlled upstream from the process (downstream from the valve). If the actual value is greater than the setpoint, the valve is closed (provided the direction of flow is 'Normal'). If acting in this way it is also known as 'pressure reducer'.</p>
6	<p><u>Back pressure control active</u></p> <p>The pressure is controlled downstream from the process (upstream from the control valve). If the actual value is greater than the setpoint, the valve is opened (provided the direction of flow is 'Normal'). In this case it is also known as an 'overflow valve'.</p>

<i>Pressure- Flow control</i>	0x0038	Write	User
		Read	User
Easy switch between flow to pressure controller or vice versa			
Wert	Bedeutung		
0	Flow automatic, not recommended. Flow setpoint must be transmitted after this command		
1	digital Setpoint		
2	Analogue Setpoint		
5	<p><u>Pressure control active</u></p> <p>The pressure is controlled upstream from the process (downstream from the valve). If the actual value is greater than the setpoint, the valve is closed (provided the direction of flow is 'Normal'). If acting in this way it is also known as 'pressure reducer'.</p>		
6	<p><u>Back pressure control active</u></p> <p>The pressure is controlled downstream from the process (upstream from the control valve). If the actual value is greater than the setpoint, the valve is opened (provided the direction of flow is 'Normal'). In this case it is also known as an 'overflow valve'.</p>		
Wert u16 (1,2 or 5,6)			

<i>Measured value, pressure</i>	0x5f00..0x5f01	Write	No access
		Read	User
Currently measured gas pressure.			
Value f32			

<i>Scaling pressure, min.</i>	0x5f02..0x5f03	Write	User
		Read	User

Lower value of the pressure transformer measurement range This value is required to scale the analog signal of the pressure transformer to the correct value range.

Value **f32**

<i>Scaling pressure, max.</i>	0x5f04..0x5f05	Write	User
		Read	User

Upper value of the pressure transformer measurement range. This value is required to scale the analog signal of the pressure transformer to the correct value range.

Value **f32**

<i>Pressure setpoint</i>	0x5f06..0x5f07	Write	User
		Read	User

Setpoint presetting for pressure control

Value **f32**

<i>Pressure unit</i>	0x5f08..0x5f0b	Write	User
		Read	User

Character string of the measured value unit of the pressure transformer.

Value **s8**

<i>Flow limiting</i>	0x5f0c..0x5f0d	Write	User
		Read	User

When flow limiting is activated, the flow is limited to this value while the pressure is controlled. Flow limiting is activated in the register (0x5f0f).

Value **f32**

<i>Pressure control mode</i>	0x5f0e	Write	User
		Read	User

Selects the source for the setpoint presetting.

Value **u16**

The following possible pre-settings are available:

Value	Significance
0	Automatic, the analog setpoint presetting is activated unless a digital setpoint is transmitted.
1	Digital setpoint presetting: the analog input waits for the measured value, the setpoint is written to the register (0x5f06)
2	Analog setpoint presetting: the analog input waits for the setpoint, the measured value is written to the register (0x5f00)

Pressure control operating mode	0x5f0f	Write	User
		Read	User

Selects functions and options for pressure control. This entails setting the corresponding bit.

Value u16

The following possible pre-settings are available:

<i>bit</i>	<i>Significance</i>
0	Flow limiting active
1	Direction of flow for pressure control inverted

Analog filter setpoint

0x5515

Write

No access

Read

User

A filter can be connected upstream from the analog signal setpoint.

The filter enables reduction of the noise at the analog supply line or suppression of the sensitive characteristic of a pressure gauge.

0 < value < 25

0 = off

15 = medium

25 = strong

Default: 0

Value uint8

PID Select Pressure

0x5f10

Write

User

Read

User

There are 5 control parameter sets in total. The corresponding parameter set is selected here.

Value u16

The following possible pre-settings are available:

<i>Value</i>	<i>Significance</i>
0	Control parameter set 0
1	Control parameter set 1
2	Control parameter set 2
3	Control parameter set 3
4	Control parameter set 4

PID Access Pressure

0x5f1f

Write

User

Read

User

This is a data pointer. It defines the control value set from which the values are displayed or written.

Value u16

The following possible pre-settings are available:

<i>Value</i>	<i>Significance</i>
0	Control parameter set 0
1	Control parameter set 1
2	Control parameter set 2
3	Control parameter set 3
4	Control parameter set 4

<i>Control parameter K_P</i>	0x5f20..0x5f21	Write	User
		Read	User
Proportional share of the control loop			
Value f32			
<i>Control parameter K_I</i>	0x5f22..0x5f23	Write	User
		Read	User
Integral share of the control loop			
Value f32			
<i>Control parameter K_D</i>	0x5f24..0x5f25	Write	User
		Read	User
Differential share of the control loop			
Value f32			
<i>Control parameter N</i>	0x5f26	Write	User
		Read	User
This parameter is not used at present.			
Value u16			
<i>Tag Name Pressure</i>	0x5f27..0x5f3f	Write	User
		Read	User
Measuring point tag, pressure transformer			
Value s50			

4. Pressure Controller GSP/GSB / ProfiBus

This chapter describes only additional registers for pressure control.

4.10 Register

Data types

The register documentation refers to the following data types:

Data typ	Format	Description	Length [Bytes]
float32	f32	Floating point number according to IEEE-754	4
string8	s8	8-character string	8
string50	s50	50-character string	50
uint8	u8	Unsigned whole number, 8 bits	1
uint16	u16	Unsigned whole number, 16 bits	2
uint32	u32	Unsigned whole number, 32 bits	4

Addresses

The following table lists the data that are accessible via Profibus.

Mode

Different memory characteristics are defined for write access:

- r read only (parameter can only be read)
- s special (set value is handled separately via register 4050)
- i immediate (value is stored in the EEPROM with each write access)
- c changed (value is stored in the EEPROM whenever there is a change)
- (value is not stored in the EEPROM)

Registers			Profibus, cyclical		Profibus, acyclical			
Description	Address [hex]	Format	Module	Read [hex] Write [hex]	Mode	Slot [hex]	Index [hex]	Length [dec]
Measured value, pressure	5F00	f32	Pressure Rd ---	43 83 00 5F 00 ---	r	5F	00	4
Scaling pressure, min.	5F02	f32	--- ---	--- ---	i	5F	02	4
Scaling pressure, max.	5F04	f32	--- ---	--- ---	i	5F	04	4
Pressure setpoint	5F06	f32	Setpoint Rd Setpoint Wr	43 83 00 5F 06 83 83 00 5F 06	s	5F	06	4
Pressure unit	5F08	s8	Pressure Unit Rd ---	43 87 00 5F 08 83 87 00 5F 08	i	5F	08	8
Flow limiting	5F0C	f32	--- ---	--- ---	i	5F	0C	4
Pressure control mode	5F0E	u16	--- ---	--- ---	c	5F	0E	2

Registers			Profibus, cyclical		Profibus, acyclical			
Description	Address [hex]	Format	Module	Read [hex] Write [hex]	Mode	Slot [hex]	Index [hex]	Length [dec]
Pressure – Flow Control (1,2 or 5,6)	0038	u16	---	---	c	00	38	2
Pressure control operating mode	5F0F	u16	---	---	c	5F	0F	2
PID Select Pressure	5F10	u16	---	---	c	5F	10	2
PID Access Pressure	5F1F	u16	---	---	c	5F	1F	2
Control parameter K_P	5F20	f32	---	---	i	5F	20	4
Control parameter K_I	5F22	f32	---	---	i	5F	22	4
Control parameter K_D	5F24	f32	---	---	i	5F	24	4
Control parameter N	5F26	u16	---	---	i	5f	26	2

