



**RedyIndustrial**

## **Instruction Manual**

Version: S-IM-RedyIndustrial

Rev. A\_EN1.0

# Global Support

## **SIERRA INSTRUMENTS, INC. -CORPORATE HEADQUARTERS**

5 Harris Court, Building L Monterey, CA 93940

Phone (831) 373-0200

[www.sierrainstruments.com](http://www.sierrainstruments.com)

## **EMEA HEADQUARTERS**

Bijlmansweid 2 1934RE Egmond aan den Hoef

The Netherlands

Phone +31 72 5071400

## **ASIA HEADQUARTERS**

Second Floor Building 5, Senpu Industrial park

25 Hangdu Road Hangtou Town

Pu Dong New District

Shanghai, P.R. China Post Code 201316

Phone: + 8621 5879 8521

## **IMPORTANT CUSTOMER NOTICE: OXYGEN SERVICE**

Sierra Instruments Inc. is not liable for any damage or personal injury, whatsoever, resulting from the use of our standard mass flow meters or controllers for oxygen gas. You are responsible for determining if this mass flow meter or controller is appropriate for your oxygen application. You are responsible for cleaning the mass flow meter or controller to the degree required for your oxygen flow application.

## **© COPYRIGHT SIERRA INSTRUMENTS 2024**



No part of this publication may be copied or distributed, transmitted, transcribed, stored in a retrieval system, or translated into any human or computer language, in any form or by any means, electronic, mechanical, manual, or otherwise, or disclosed to third parties without the express written permission of Sierra Instruments. The information contained in this manual is provided for information only and is subject to change without notice. Sierra Instruments assumes no responsibility or liability for any errors or inaccuracies in this manual.

## **TRADEMARKS**

Redy<sup>®</sup>, RedyIndustrial<sup>®</sup> and RedySmart<sup>®</sup> are a Registered Trademark of Sierra Instruments, Inc. Other product and company names listed in this manual are trademarks or trade names of their respective manufacturers.

# Warnings and Cautions

“Warning,” “Caution,” and “Note” statements are used throughout this manual to draw your attention to important information.

Symbol Key		
Symbol	Symbol Meaning	Description
	Warning	“Warning” statements appear with information that is important to protect people and equipment from damage. Pay very close attention to all warnings that apply to your application. <b>Failure to comply with these instructions may damage the meter and cause personal injury.</b>
	Caution	“Caution” indicates that failure to comply with stated instructions <b>may result in damage or faulty operation of the meter.</b>
	Note	“Note” indicates that ignoring the relevant requirements or precautions may result in flow meter damage or malfunction.



**Warning!** Do not remove the electronics housing. A damaged hologram seal will expire (cancel) the warranty.

**Warning!** There are no serviceable parts inside the flow meter or controller

**Warning!** Repairs must be performed by a qualified Sierra personnel.

**Warning!** It is strongly recommended to have this device grounded. The supply voltage is 18-30 VDC

**Subject to Change:** Due to our policy of ongoing product development, we reserve the right to change the information in this manual without notice.

**Toxic, Flammable Gases and ATEX:** In the case of toxic and flammable gases, the respective safety guidelines in each country must be followed. This RedyIndustrial device is ATEX certified for Zone 2 and Zone 22. In the case of flammable and toxic gases, fittings, cable glands and pipes intended for that purpose must be used. The responsibility for safe operation lies with the designer of the facilities.

The devices must not be used for explosive mixtures and Zone for which it is not certified. Carefully read and follow all instruction in the addendum of this manual that described the ATEX approval.

### **Installation**

Please note before the start-up:

- Do not use sealing tape or liquid sealant
- Piping must be cleaned before installation of instrument

Products in this manual may contain metal or elastomeric seals, gaskets, O-rings or valve seats. It is the “user’s” responsibility to select materials that are compatible with their process and process conditions. Using materials that are not compatible with the process or process conditions could result in the devices leaking gas outside the pressure boundary of the device, resulting in personnel injury or death.

It is recommended that the user check the devices on a regular schedule to ensure that it is leak free as both metal and elastomeric seals, gaskets, O-rings and valve seats may change with age, exposure to process gas.

**Warning! Power** - If it becomes necessary to remove the instrument from the system, power to the device must be disconnected. Always switch of the power before you disconnect terminal connections in potentially dangerous surroundings to avoid sparks.

# RedyIndustrial® Series Instruction Manual

This manual is for RedySmart Series models:

- RedyIndustrial Meters (GIM)
- RedyIndustrial Controller (GIC)

## Receipt of System Components

When receiving a Sierra mass flow meter, carefully check the outside packing carton for damage that may have incurred in shipment. If the carton is damaged, notify the local carrier and submit a report to the factory or distributor. Remove the packing slip and check that all ordered components are present and match your specifications (as ordered). Make sure any spare parts or accessories are not discarded with the packing material. Do not return any equipment to the factory without first contacting [Sierra Customer Service](#).

## Technical Assistance

If you encounter a problem with your flow meter, review the configuration information for each step of the installation, operation, and setup procedures. Verify that your settings and adjustments are consistent with factory recommendations. Installation and troubleshooting information can be found in this manual. See Chapter 3 for installation and Chapter 4 for troubleshooting.

If the problem persists after following the troubleshooting procedures outlined in this manual, contact Sierra Instruments email (see inside front cover). For urgent phone support you may call +1 (831) 373-0200 between 8:00 a.m. and 5:00 p.m. PST. In Europe, contact Sierra Instruments Europe at +31 20 6145810. In the Asia-Pacific region, contact Sierra Instruments Asia at +86-21-58798521. When contacting Technical Support, make sure to include this information:

- The flow range, serial number, and Sierra order number (all marked on the meter nameplate)
- The software version (visible at start up)
- The problem you are encountering, and any corrective action taken
- Application information (gas, pressure, temperature and piping configuration)

## Recycling



Note the existing regulations of your country.

# Table of contents

<b>Warnings and Cautions</b>	<b>3</b>
<b>Table of contents</b>	<b>6</b>
<b>1. Introduction</b>	<b>8</b>
1.10 Features of Industrial thermal mass flow meters and controllers	8
1.11 Scope of warranty	8
1.12 Instructions and warnings	9
1.13 Documentation supplied	9
1.14 The measurement principle	10
1.15 CMOS technology	11
1.16 Block diagram	11
<b>2. Technical data</b>	<b>12</b>
2.10 General device specifications	12
2.11 Mechanical specifications	12
2.12 Electrical data	13
2.13 Measurement ranges (air)	13
2.14 Terminal assignment (Modbus, power supply, analog signals)	14
2.15 Analog signals	15
2.16 Serial interface	16
2.17 Plug pin assignment, PROFIBUS	16
2.18 Calibration	16
2.19 Operation with other gases	16
2.20 Pressure loss	17
2.21 Temperature compensation	17
2.22 Pressure compensation	17
2.23 Response time	17
2.24 Control Behavior	17
<b>3. Installation and Commissioning</b>	<b>18</b>
3.10 What We Supply	18
3.11 Mounting position and mounting location	18
3.12 Requirements for pipework	18
3.13 Recommended filter fittings:	19
3.14 Filters / Gas cleanliness	20
3.15 Electrical power supply	20
3.16 Grounding	22
<b>4. Operation and maintenance</b>	<b>23</b>
4.10 Warm-up time	23

4.11 Maintenance / Calibration check	23
4.12 Cleaning to remove contamination	23
4.13 Return	24
<b>5. RedySmart Smart Interface Portal Software (SIP) Software</b>	<b>25</b>
5.10 Introduction	25
5.11 Functions	25
5.12 On-screen help	25
5.13 Digital communication	25
<b>6. Appendix</b>	<b>26</b>
6.11 Troubleshooting	26
6.12 Measurement & control of flow rate	26
6.13 Pressure loss	31
6.14 Dimensional drawings in mm	33
6.15 Dimensional drawings in inches	35
6.16 Communication Cable PDM-U	37
6.17 Type code overview	38
6.18 Wetted parts RedyIndustrial series	40
6.19 Contamination clarification	41
6.20 ATEX Zone 2 and 22	42
6.21 Change history	45
<b>7. Index</b>	<b>46</b>

# 1. Introduction

Thank you for choosing devices from the RedyIndustrial product line. This manual will help you to install and operate the measuring devices. Please read through these instructions carefully before installing the devices. Our aim has been to write a full and practical guide. We would be grateful if you would notify us of any shortcomings or mistakes.

Please contact your sales partner if you have questions about any aspect of the products.

The core element of the RedyIndustrial thermal mass flow meter and controller is a CMOS sensor chip. The sensor and parts of the electronics are on one board and offer a number of advantages for the user.

## 1.10 Features of Industrial thermal mass flow meters and controllers

In developing and manufacturing the devices, we have focused primarily on customers and their applications. Our aim is to implement customers' requirements in the form of new developments or enhancements on an ongoing basis. The essential features are:

- Compact design
- Suitable for IP67 and Zone 2 and 22 rated environments
- Standardized digital and analog interfaces
- Very fast and accurate measurement and control
- Integrated temperature measurement and totalizer (standard)
- Easy to maintain and service
- Thanks to its modular design, the unit can be easily expanded to add additional functions
- 3-year warranty
- Matched options and accessories

## 1.11 Scope of warranty

Warranty for the Redy Series product line extends to material and manufacturing defects only. Maximum warranty covers product replacement free of charge. The following causes of faults/damage are not covered under warranty:

- Use outside the operating limits
- Damage due to corrosion
- Mechanical damage in general
- Contamination due to improper sealing
- Contamination due to impure gasses or penetration of liquids
- Damage to electronic components due by over-voltage or electrostatic discharges, and corrosion damage due to aggressive environments.
- Functional failure due to incorrect operation or faulty parameterization



- If the unit has been opened or otherwise tempered with.
- Drift in the calibration

## 1.12 Instructions and warnings

Read all of the operating instructions thoroughly before installing and commissioning equipment. Misconceptions and incorrect use can lead to breakage of the measuring device or risk of personal injury.

The installation, commissioning and operation and maintenance must be done by appropriately qualified personnel.

## 1.13 Documentation supplied

Each delivery includes a CD-ROM with the following content:

- The *RedySmart Smart Interface Portal Software (SIP)* software for parameterizing, service and configuration
- Driver for the USB communication cable, type PDM-U (Cable sold separate)
- Operating instructions:
  - *RedyIndustrial series, Part I: General operating instructions (this manual)*
  - *RedySmart series, Part II: Digital communication*
- ⇒ Further information is available for download on our homepage:
  - Operating instructions, *RedyIndustrial series*.
  - Operating instructions, electronic analysis system *PCU 1000*
  - Operating instructions, *V-Flow Line* (mechanical devices)
  - All data sheets
  - Contamination clarification
  - Various certificates and declarations
  - General Terms and Conditions of Sale

## 1.14 The measurement principle

The thermal measurement principle is particularly suitable for the flow measurement and control of clean and dry gaseous media. The most significant advantage is that the measurement process is largely independent of temperature and pressure. The displayed flow refers to the “normalized” gas volume at 0 °C and 1013.25 mbar absolute. (f.i. Ln/min). On request, other reference temperatures can be provided.

Most natural gas suppliers base their volume data on 15 °C and 1013.25 mbar absolute. According to the ideal gas law, the gas volume will change by 0.35% per K.

In the USA most companies use “standardized flow” (f.i. SLPM). These standard values use the reference conditions of 70 °F (21.1 °C) and 760 mmHg (abs)=(1013.25 mBara) and are about 7.2% different from “Normal” conditions.

Stated simply, the thermal measurement principle measures the heat transport by gas flowing past.

In the case of *Redy Series* mass flow measuring instruments, a constant heat input gives a flow-dependent temperature difference ( $\Delta T$ ). Two temperature sensors are positioned in the measuring channel (T1, T2), one before the heating system (H) and one after it.

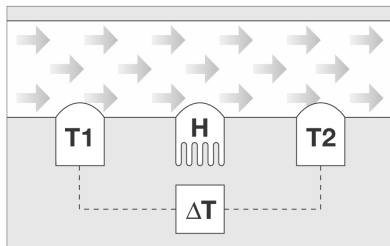

Figure 1: The measurement principle

If there is no flow, the heat spreads symmetrically in directions T1 and T2. The temperature difference T1-T2 is therefore zero.

Flow rates  $> 0$  create a temperature difference.

The sensor T1 at the inlet is cooled by the gas flowing past it, and the temperature of the second sensor T2 rises due to the heat drawn from the heating system.

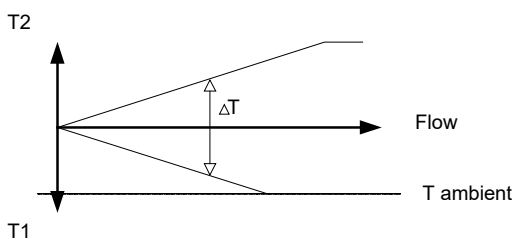

Figure 2: Sensor signals

The temperature difference is related non-linear to the mass flow, with a very high repeatability. The electronics will based on the calibration convert this temperature difference in a linear and proportional indication of the mass flow of the gas.

## 1.15 CMOS technology

The *RedyIndustrial* measuring and control devices are equipped with an innovative semiconductor sensor that sets new standards for accuracy, speed and measurement dynamics.

With CMOS technology (which we use), the sensor element, amplifier and A/D converter form a single unit on the silicon chip.

## 1.16 Block diagram

The following block diagram shows the structure of the device.

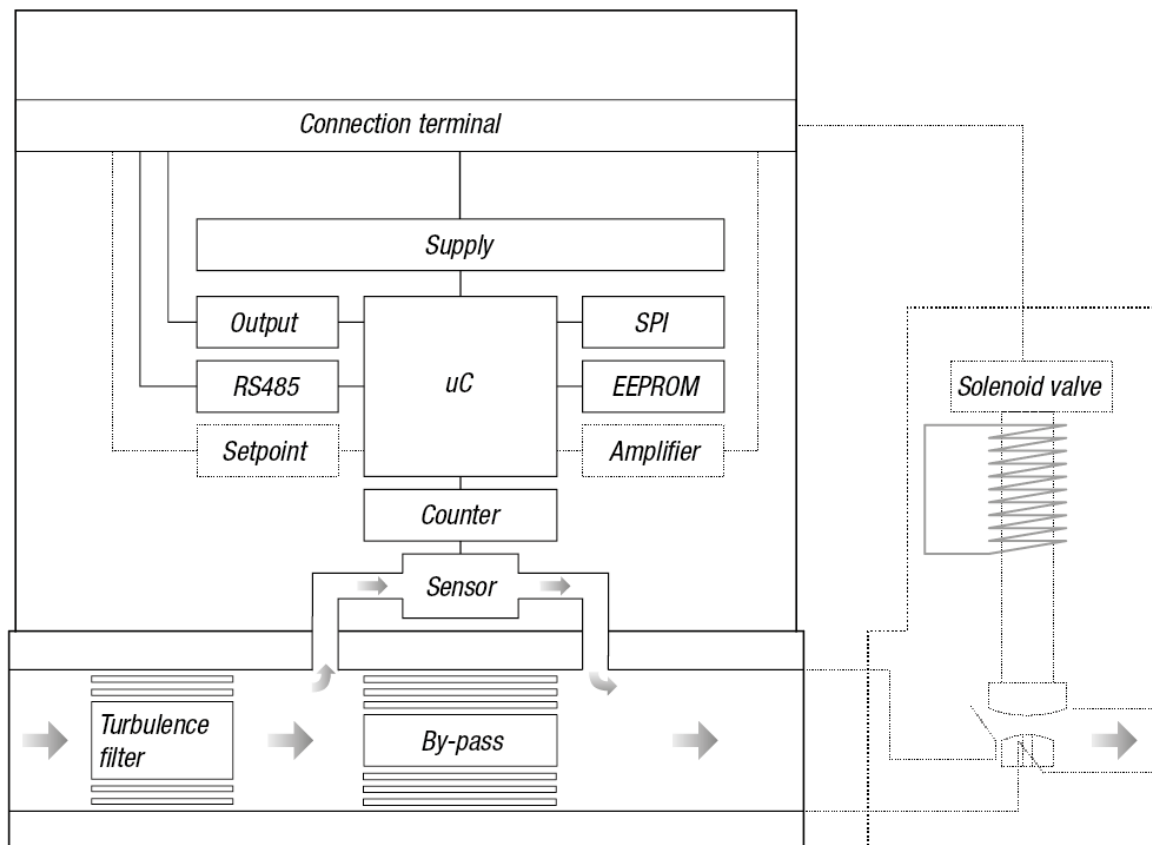

Figure 3: Block diagram

## 2. Technical data

### 2.10 General device specifications

#### Accuracy

Standard	±1.0% of full scale
Hi-Performance	±0.3% of full scale, ±0.5% of reading
<i>For GIM &lt; 200 In/min Air and GIC &lt; 150 In/min Air</i>	

#### Dynamics

Standard	1:50 (signal suppression less than 1.7% of full scale)
Hi-Performance	1:100 (signal suppression less than 0.83% of full scale)

Response time: 50 ms (Controllers 150 msec but application dependent)

Reproducibility: ±0,2% of full scale

Long-term stability: < 1% of reading / year

Temperature coefficient: < 0.025% FS measuring range type per °C  
< 0.012% FS measuring range type per 1°F

Pressure coefficient: < 0.2% / bar of reading (typical N2)  
< 0.014% / psi of reading (typical N2)

Control stability: ±0,2% of full scale

Working pressure range: 0.2 - 11 bara (Note: GIC with valve type 4.5 and 8: max 8 bara)  
3 - 160 psia (Note: GIC with valve type 4.5 and 8: max. 120 psia)

Test pressure: 16 bar a

Storage conditions: -20 to 80°C (-4 to 176°F), 0-95% RH, non-condensing

Temperature range: 0 – 50°C (32 bis 122°F), 0-95%, RH, non-condensing

*Do not expose device to direct sun light.*

#### Leakage rate

Externally:  $1 \times 10^{-6}$  mbar\*l/s He

Control valve:  $1 \times 10^{-6}$  mbar\*l/s He

Warm-up time: < 1 sec. for full accuracy

### 2.11 Mechanical specifications

#### Materials

Housing: Anodized aluminum, stainless steel 1.4404 (316L)

Body Material: Stainless steel 1.4404 (316L)

Sensor area: Silicon, glass, epoxy

Seal material: EPDM, optional FKM

Mechanical connection (types A, B, C): G1/4" (BSPP) female thread at both ends, optional with fittings (see appendix 'Accessories')

Mechanical connection (type D): G1/2" (BSPP) female thread at both ends, optional with fittings (see appendix 'Accessories')

Protection class: IP-67  
 Wetted parts: See appendix

## 2.12 Electrical data

Supply voltage: 18..30 VDC (typically  $\pm 50$  mV)

*Current consumption*

Flow meter, GIM: Max. 100 mA  
 Flow controller, GIC: Max. 250 mA (8 mm valve: max. 300 mA)

*Analog inputs and outputs*

Voltage: 0..5 V, 1..5 V, 0..10 V, 2..10 V, user-specific  
 Input impedance: 100 kohm  
 Minimum load: 1 kohm (at 24 Vdc)  
 Current: 0..20 mA, 4..20 mA, user-specific  
 Input impedance: 250 ohm  
 Maximum load: 900 ohm (at 24 Vdc)

*Digital communication*



RS-485, protocol: ModBus RTU (slave)  
 optional Profibus DP-V0, DP-V1

Control parameters: can be set via digital communication  
 Valve driver 16 Vdc, Pulse width modulation 7 Khz. Max. 20W

## 2.13 Measurement ranges (air)

	Type	Measurement ranges (air), scale freely selectable	
<b>Industrial meter GIM:</b>	GIM-A	from 0 ... 25 mln/min	to 0 ... 600 mln/min
	GIM-B	from 0 ... 600 mln/min	to 0 ... 6000 mln/min
	GIM-C	from 0 ... 6 ln/min	to 0 ... 60 ln/min
	GIM-D	from 0 ... 60 ln/min	to 0 ... 450 ln/min
<b>Industrial controller GIC:</b>	GIC-A	from 0 ... 25 mln/min	to 0 ... 600 mln/min
	GIC-B	from 0 ... 600 mln/min	to 0 ... 6000 mln/min
	GIC-C	from 0 ... 6 ln/min	to 0 ... 60 ln/min
	GIC-D	from 0 ... 60 ln/min	to 0 ... 450 ln/min
Optional low flow range		0.2 ... 10 mln/min	

## 2.14 Terminal assignment (Modbus, power supply, analog signals)

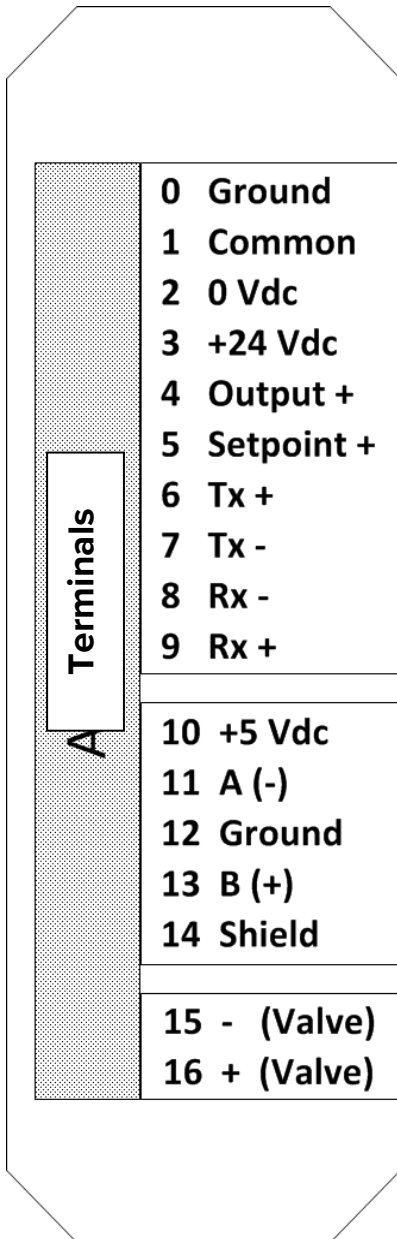

0	<b>Ground/Shield</b>	Connected to housing
1	<b>Common (-)</b>	GND analog signals
2	<b>Supply 0 Vdc</b>	0 VDC supply voltage
3	<b>Supply +24 Vdc</b>	+24 VDC supply voltage
4	<b>Output (+)</b>	Analog output, measured value
5	<b>Setpoint (+)</b>	Analog input, setpoint
6	<b>Tx+ RS-485</b>	RS-485 Output (Y)
7	<b>Tx- RS-485</b>	RS-485 Output (Z)
8	<b>Rx- RS-485</b>	RS-485 Input (B)
9	<b>Rx+ RS-485</b>	RS-485 Input (A)
10	<b>+5V</b>	Maximum load 100 mA
11	<b>RS-485 (A or -)</b>	Profibus-DP Comms (A or -)
12	<b>Digital Ground</b>	Ground for digital signals
13	<b>RS-485 (B or +)</b>	Profibus-DP Comms (B or +)
14	<b>Shield</b>	Connection Analog ground
15	<b>Control valve connection</b>	For MFC option only
16	<b>Control valve connection</b>	For MFC option only

### Terminal assignments:

Terminals 1-5: Power supply and analog connections

Terminals 6–9: Modbus communication

Terminals 10-14: Profibus-dp communication (Optional)

Terminals 15-16: Valve connection (Optional: for Mass and Pressure controllers only)



**WARNING.** First remove the supply power before you open the housing or connect/disconnect any of the terminals if in a hazardous area.

## M12 pin assignments (Optional)

Optional contra M12 cables are available from your distributor. (Loose plug or plug with cable)

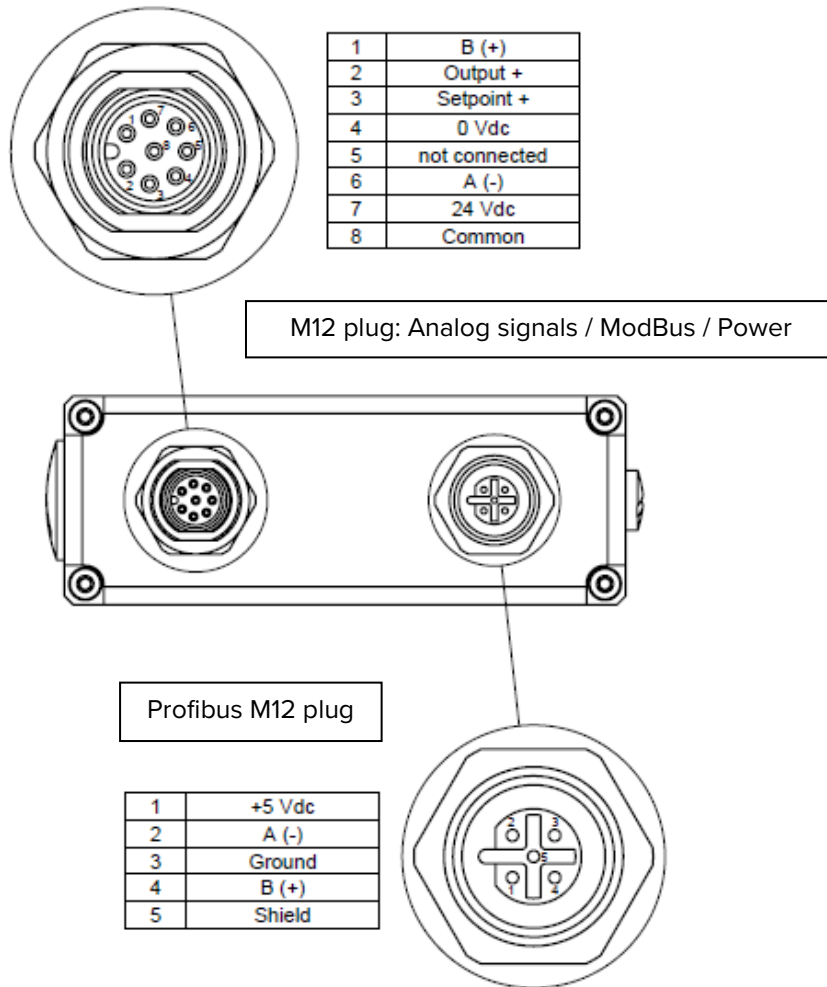

 **First remove the supply power before you open the housing or connect/disconnect any of the terminals if in a hazardous area.**

## 2.15 Analog signals

The analog input and output signals can be configured with the *RedySmart Smart Interface Portal Software (SIP)* software which can be downloaded for free on our website.

**The analog signals have no potential separation. Pin 1 and Pin 2 are connected internally. Potential differences have to be compensated with a suitable installation with external connections.**

 **NOTE:** Please note that suitable isolating transformers have to be used for potential differences between the analog and digital range on the system side.

## 2.16 Serial interface

In addition to its analog interface, the *RedyIndustrial* has, as standard, a digital interface with the ModBus protocol. This interface enables access to numerous parameters.

In Part II of the operating instructions, 'Digital Communication', you will find all the information about the correct bus connection and the software parameters.

All manuals can be downloaded from our website [www.sierrainstruments.com](http://www.sierrainstruments.com).

**The digital interface has no potential separation.**



**NOTE:** Please note that suitable isolating transformers have to be used for potential differences between the digital communication and supply voltage on the system side.

## 2.17 Plug pin assignment, PROFIBUS

An optional Profibus-DP interface is available. The pin assignment for the connection on the terminal board is shown in the above table.

This website has further information about Profibus hardware: <http://www.profibus.com/>

## 2.18 Calibration

Each measuring device is supplied with a factory calibration report. On request we can also provide DAKKS calibration (German Accreditation Body). The calibration is compatible with American and European standards. Each measuring device can store data for up to 10 types of gas or operational states.

## 2.19 Operation with other gases

CMOS sensors are not linear (The output is linearized) and respond different to each gas. If the gas or gas composition is different then the gas that the unit was calibrated for, the unit will not measure accurately. It is possible to program up to 10 different gasses and gas mixtures, but this needs to be done at the factory or at a Vögtlin certified calibration center. Please contact the factory for addition information.



**NOTE:** Please note that, among other effects, the zero-point error (offset display) will be higher if the device is not operated with the type of gas, for which it had been calibrated. A difference in zero indication is also possible if the used pressure is different than specified.



## 2.20 Pressure loss

The thermal mass flow meters and controllers have a low pressure drop. The pressure drop depends mainly on the medium, the pressure conditions and the flow rate. Your sales partner has a calculation program. You will find the pressure-loss curves for the measuring devices at the end of this guide. In the case of a flow controller, the pressure differential required for the valve itself must be taken into account.

Please note that the size of the pipes has a large effect on the pressure loss. For example from around 60 l/min, we recommend a pipe inside diameter of at least 10 mm.

Please also note that some fittings have a reduced diameter and can cause considerable pressure drop in your system.

## 2.21 Temperature compensation

Thermal mass flow meters measure the flow of gases, the result being largely independent of pressure and temperature. The sensor measures the gas temperature and, with the help of a 3-dimensional table of interpolation values, a correction factor is calculated automatically. The available output signal is thus temperature-compensated. The accuracy of the temperature measurement is  $\pm 1$  °C. (Temperature reading available through Modbus and Profibus only)

## 2.22 Pressure compensation

During calibration, the specified operating pressure is allowed for. Changes to the pressure conditions may introduce an additional error. This is around  $\pm 0.2\%$  per bar. Please note that the control behavior is influenced by substantially different pressure conditions.

## 2.23 Response time

The CMOS sensor has a very fast response time of 50 ms. This is available directly at the output signal. In digital communications, the bus size and the speed are far more important in practice.

## 2.24 Control Behavior

The control behavior can be adapted to suit the application. There are 3 sets of parameters (slow, medium and fast). At shipment, one set is pre-programmed as User 1, which corresponds to a “medium”. You can select these with the *RedySmart Smart Interface Portal Software (SIP)* software.

## 3. Installation and Commissioning

### 3.10 What We Supply

We ship the device with the following accompanying documentation:

- With each device, 1 factory calibration certificate
- With each device, 1 final inspection report
- With each shipment, Product Information Card
- Each shipment contains one converter cable from the terminals to the D9 connector.

### 3.11 Mounting position and mounting location

We always recommend a horizontal mounting position. This can be upright, sideways or upside down. With a vertical mounting position, dependent on the type of gas and at gauge pressures above 5 bar, a zero-point offset can develop. This effect is caused by convection in stationary media.

With regard to mounting location, the following situations can cause problems:

- Strong heat sources, or ambient temperatures outside the specification
- Strong sources of electromagnetic radiation such as spark discharges
- Humid environments and the associated condensation lead to damage of the electronic components
- Particularly in the case of flow controllers, strong vibrations will cause unstable control.
- In general, aggressive environments reduce the service life.
- Liquid running backwards can penetrate into the measuring instrument. An elevated mounting location generally helps, or using check valves.
- If your ambient air contains high humidity, you close the cover and at night the temperature goes down, it is possible that you get some condensation inside the unit. Please take precautions to avoid this. (Please note that very high flows and big pressure drops over the valve will also cause a cooling of the mass flow controller)

### 3.12 Requirements for pipework

The most common causes of faults concern the way that devices are connected to the gas supply. Please note the following points:

- The pipes must be absolutely clean. Please flush them **before** installing the measuring instruments!
- Please ensure there are no pieces of thread sealant (f.i. Teflon tape) in the piping!
- Use appropriate pipe materials (pressure rating, durability)
- Even when connected to fixed pipework, we recommend that the devices are mounted using the appropriate mounting holes

- From 50 l/min, we recommend the following flow-calming sections of straight and unobstructive straight tubing: Inlet: 10 x diameter; outlet: 5 x diameter
- Use appropriate fittings (see chapter 3.13)
- Malfunctions can be caused by unstable pressure controllers, pumps that oscillate, and volumes before and/or after the measuring device that are generally too small. Install an air reservoir with 2 liter volume in the feed pipe.(2 liter is an example, the volume depends on the application)
- The size of the pipe must be matched to the measuring/control device. A diameter that is too small results in an increased pressure drop.
- Please note the grounding connections specified in a separate chapter
- Check for any leaks before commissioning the devices
- For maintenance work, we recommend that a bypass system is used. This is particularly important where the gas supply must not be interrupted

### Sealants

The design of the devices enables sealing at the ends with O-rings or flat seals. It is **essential** that you **avoid**:

- the use of sealing tape to seal threads. Small pieces can cause incorrect measurements and control-valve malfunctions. As well as that, if the device has to be checked or recalibrated, there will be an extra charge for the additional cleaning work.
- sealing with liquid sealants will incur a higher cleaning charge for cleaning the device in an ultrasonic tank.

## 3.13 Recommended filter fittings:

We are happy to supply the appropriate fittings with 50µ filter. The fittings are designed for end-sealing and have an integral inlet filter.

### Types

Part No.	Type/Connections	Material
328-1021	G ¼" auf 6 mm	Edelstahl, EPDM
328-1022	G ¼" auf ¼"	Edelstahl, EPDM
328-1023	G ¼" auf 12mm	Edelstahl, EPDM
328-1024	G ¼" auf ½"	Edelstahl, EPDM
328-1025	G ¼" auf 8 mm	Edelstahl, EPDM
328-1001	G ¼" auf 6 mm	Edelstahl, FKM
328-1002	G ¼" auf ¼"	Edelstahl, FKM
328-1003	G ¼" auf 12mm	Edelstahl, FKM
328-1004	G ¼" auf ½"	Edelstahl, FKM
328-1005	G ¼" auf 8 mm	Edelstahl, FKM



### Pressure loss (air)

Flow rate	Pressure loss G ¼"	Flow rate	Pressure loss G ½"
5 l/min	2.2 mbar	50 l/min	5 mbar

20 l/min	25 mbar	100 l/min	10 mbar
40 l/min	85 mbar	200 l/min	30 mbar
60 l/min	180 mbar	300 l/min	70 mbar
		400 l/min	140 mbar

#### Installation

The fittings are supplied in pairs: they should be installed with filter at the inlet and without filter at the outlet.

The fitting with a filter must be installed at the inlet (as determined by the flow direction). The sealing rings (O rings) must not be damaged during assembly.

For more information, see the data sheet for the fittings

### 3.14 Filters / Gas cleanliness

We always recommend that a filter, or at least a fine-mesh sieve (50 microns), is installed before the measuring devices. It often happens that solid matter such as welding residues, metal or plastic chips, rust, sealing tape, etc. affect the function.

In pressurized-air applications using compressors, the air must be dry and free of oil. Please ensure that a suitable processing unit is located before the devices. In the case of gases from cylinders, in general no special filtering is needed. For more information, see Operation / Maintenance on the following pages.

### 3.15 Electrical power supply

Please note our option datasheet “Cables RedyIndustrial series” and “Power supply” on our homepage. If you want to make up the cable yourself, please note the connection diagrams in this manual and the applicable EMC requirements. With power cords more than 3 meters long, use appropriate filter elements. Be aware of possible ground loops if you ground electrically conductive pipes.

The supply voltage can be in the range +18..30 VDC and should have the smallest possible residual ripple (typically  $\pm 50$  mV).



**WARNING:** Please check that the devices have been correctly wired before you connect them to the appropriate power supply.

Unprofessional cable routing can result in troublesome voltage drops and earth loops.

Please check that the devices have been correctly wired before you connect them to the appropriate power supply. Unprofessional cable routing can result in troublesome voltage drops and earth loops.

### Cable for the analog signals

Optimum results are only achieved with the right wiring. Exclusively shielded and twisted cable should be used for connection to an analog measuring device (PLC).

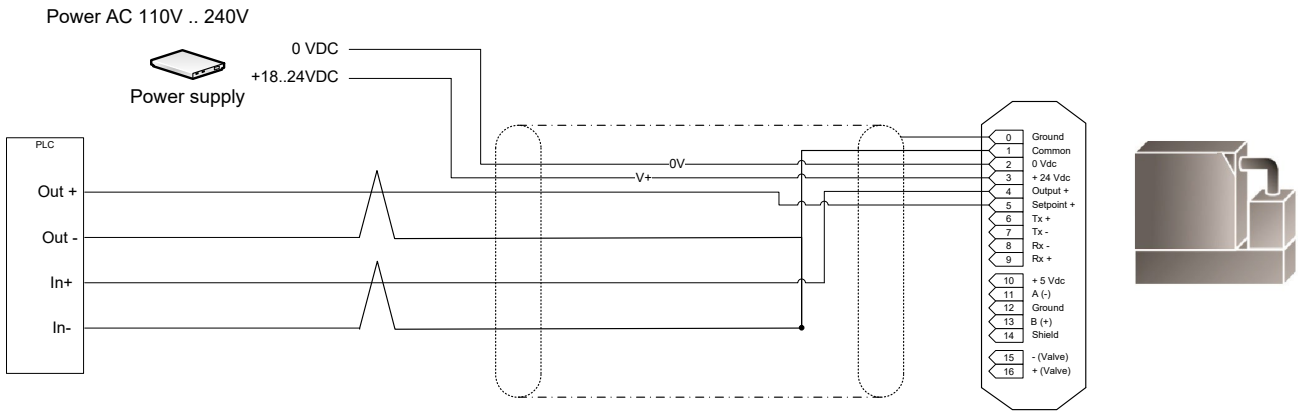

Please run the cable as shown above in the illustration.

We recommend the 4..20mA current measurement. Keep the following in mind for voltage signals: high-ohm voltage inputs are susceptible to noise (EMC) and long cables produce a voltage drop = measurement error if you voltage signals.

### Cable for digital communication

Optimum operation can only be obtained with the correct wiring. Use exclusively shielded and twisted cable material for connection to a RS485 interface.

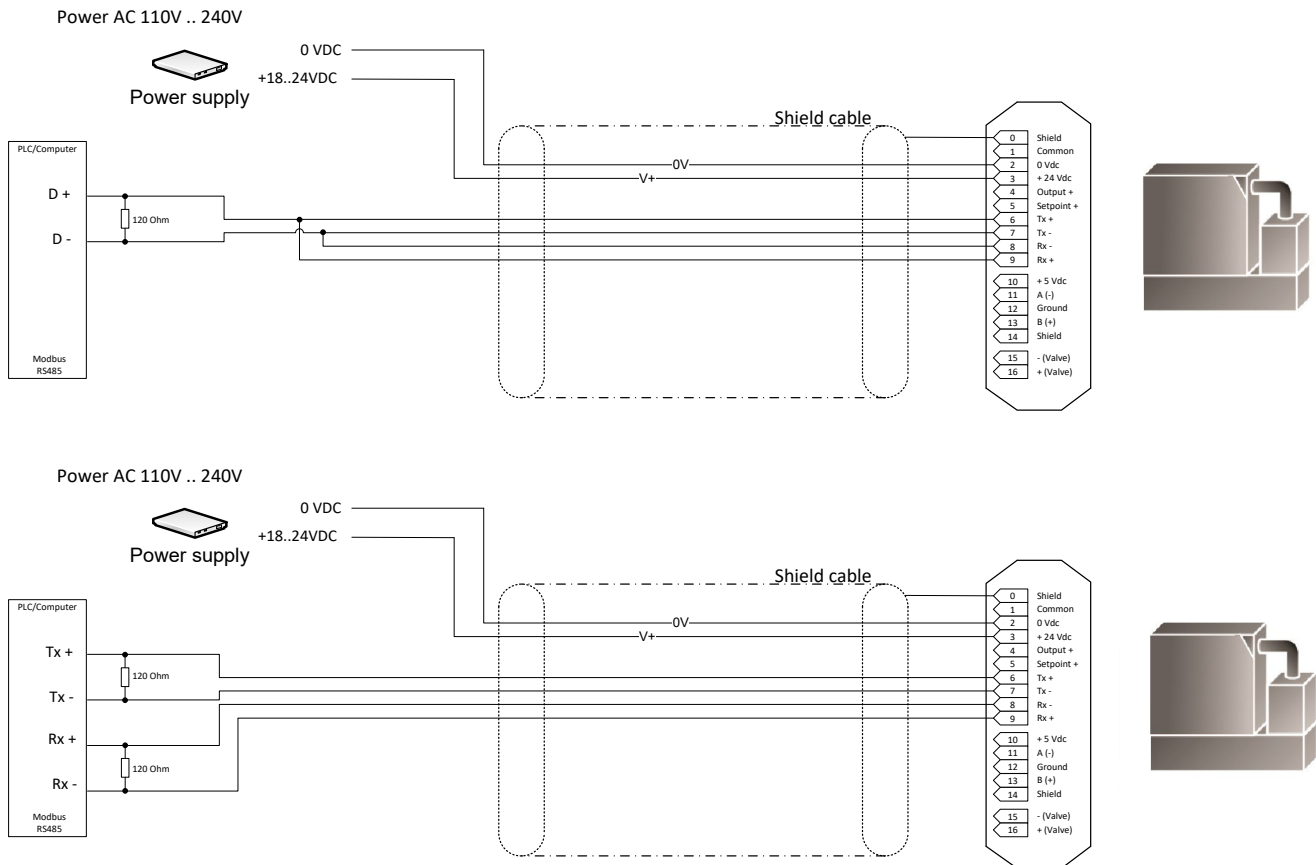

The 120 Ohm resistors are generally not built into the RS485 converter. They must be provided externally and are essential for the RS485 current loop operation.

The resistors are already integrated in the PDM-U (USB-RS485 converter) interface from Vögtlin Instruments, available as an accessory. This interface is ideal for use in the laboratory.

Every delivery has one adaptor cable supplied (PN 328-2177) with which you can connect the terminals to an optional PDM-U Adapter cable (D9 connector). This cable has a build-in converter from RS485 to USB. The USB can be connected to your computer and once you install the RedySmart Smart Interface Portal Software (SIP) software you can configure the unit. Please note that you have to connect a power supply, so the unit is powered up during the configuration process. For more information see chapter 5.

If you misplaced this adapter cable please contact your distributor and state you require cable no. 328-2177 (Service Communication Cable for the Industrial unit).

### 3.16 Grounding

As a ground terminal, use the threaded M4 hole on the side of the RedyIndustrial marked with .

Make sure that the meter is grounded before connecting it to the power supply.

The metallic connector housing is connected to the equipment ground. The maximum permissible fault voltage between supply 0Vdc and grounding must not exceed 30Vpeak.

## 4. Operation and maintenance

### 4.10 Warm-up time

All instruments of RedySeries line are ready for use within 1 second of connecting the power. There is no significant warm-up time.

### 4.11 Maintenance / Calibration check

When operated properly and the use of clean and dry gas, *Redy Series* devices do not require any routine maintenance. We recommend that the calibration is checked after 12 months, however, if it still within tolerance, this time interval can be extended. The timing of the periodic check is the customer's responsibility.

### 4.12 Cleaning to remove contamination

Depending on the type of contamination, on-site cleaning of the measuring or control device may be possible. As a first step, we recommend flushing with N<sub>2</sub> or dry air. If it is contaminated with liquids (ex. oil), pure ethanol alcohol (100%) can be used. Please rinse after cleaning the device with valve position 100% open with dry air or nitrogen for approximately 15 min. to dry all liquids. With a flow controller, it is helpful if you operate it with the *RedySmart Smart Interface Portal Software (SIP)* software to open the valve. A mechanical opening of the valve is not possible.

Please read chapter 5 for more information on the RedySmart Smart Interface Portal Software (SIP) software.



#### Notes:

- ⇒ **The warranty is null and void if the housing was removed.**
- ⇒ Only use the proper tools.
- ⇒ Be careful when handling the device and the individual components.
- ⇒ Make sure that the disassembly environment is clean.
- ⇒ On no account must you touch the circuit board or electronic components without first grounding yourself and the surroundings. Electrostatic discharges can destroy components.
- ⇒ After cleaning, you should have the device checked or if necessary recalibrated by your sales partner at the next opportunity.

## Flow splitter disassembly

If the basic body has become contaminated the flow splitter can be removed. The removal should only be done by trained service personnel. Removal and Assembly can potentially shift the calibration of a unit a little bit. Disassembly is different for the different device types:

*The fourth letter of the article code defines the type of the flow splitter. For example: GIC-**B**9-BB22 contains a flow splitter of the type **B**.*

### Type A

- ⇒ First release the slotted screw in the center of the flow splitter (approx. 5 turns)
- ⇒ Unscrew the whole flow splitter with an Allan key

### Type B, C

- ⇒ Unscrew the whole flow splitter with an Allan key

### Type D (G 1/2“)

- ⇒ First unscrew the locking pin (underside of the body) with an Allan key
- ⇒ Unscrew the flow straightener with a suitable tool
- ⇒ Pull the flow splitter out of the body
- ⇒ Flow splitter assembly
- ⇒ Carry out the steps described above in reverse order
- ⇒ After correct assembly flush *RedyIndustrial* with dry inert gas.
- ⇒ Check that the cleaned measuring device is functioning correctly by checking the zero point and some defined measurement values, for example.

## Recalibration

It is mandatory to recalibrate the instrument after the exchange of the flow splitter.

## 4.13 Return

When returning a measuring or control device, use the original packaging if possible, or other suitable packaging. So that we may serve you quickly, we would be grateful if you briefly describe the possible causes of the faults.



**NOTE:** If the device has come into contact with aggressive or toxic gases, please ensure that it is properly cleaned/flushed before returning the device to us. Please always complete the contamination declaration form. You will find these in the appendix or in the enclosed CD.



## 5. *RedySmart Smart Interface Portal Software (SIP)* Software

### 5.10 Introduction

*RedySmart Smart Interface Portal Software (SIP)* is configuration software that allows you to easily check and modify device parameters. In addition, you can use *RedySmart Smart Interface Portal Software (SIP)* to check your interface wiring, depict the bus structure, and modify device addresses if necessary. You can also download the RedySmart SIP as required from our website for free <https://www.sierrainstruments.com/products/downloads/redy-smart>. *RedySmart Smart Interface Portal Software (SIP)* runs on computer systems with the Windows 7/XP/NT/2000/98 operating systems.

The only accessories you need are a USB converter cable (PDM-U) and a power supply. (See data sheet cables, power supply). The adapter cable from the screw terminal to the 9 pin USB converter cable (PDM-U) is supplied with your order. (pn: 328-2177)

### 5.11 Functions

The *RedySmart Smart Interface Portal Software (SIP)* software provides the following function blocks for you:

- ⇒ Configuration of the serial computer interface
- ⇒ Setting the program language
- ⇒ Scanning and depicting the bus structure
- ⇒ Integrating individual devices into the bus structure
- ⇒ Reading the device-specific hardware and software versions
- ⇒ Displaying the reading, the totalizer and temperature for each device
- ⇒ Resetting the totalizer
- ⇒ Setting the setpoints
- ⇒ Selecting the control parameter sets
- ⇒ Setting the PID control parameters and checking performance
- ⇒ Selecting the active gas type
- ⇒ Optional data logging (price add-on)
- ⇒ Optional gas mixture (price add-on)
- ⇒ Optional gas verification/calibration (price add-on)

### 5.12 On-screen help

Within the program, the functions are described in the Help menu.

### 5.13 Digital communication

For detailed information on the digital interfaces, see the separate operating instructions.

## 6. Appendix

### 6.11 Troubleshooting

In the following table we have compiled fault symptoms, their possible causes and suitable measures. If you do not recognize your fault symptom, or the proposed measures were not successful, please consult your sales partner.

If you are planning to return a product, please refer to the chapter 'Returns'.

If you have to remove the measuring or control device from the pipeline, please observe any flushing procedures and the relevant safety guidelines.

You will find a guide on how to remove and clean the devices in the chapter 'Operation and maintenance'.

### 6.12 Measurement & control of flow rate

Error	Possible causes	Measures
Output signal is larger than the setpoint	Valve is contaminated and cannot close fully	Flush the valve by repeated 'Valve 100%' open/close in the <i>RedySmart Smart Interface Portal Software (SIP)</i> software under 'Signals'. Please consult your sales partner
	The setpoint and actual-value signals were set differently, ex. setpoint 0-20 mA / actual value 4-20 mA	Operate the device with the <i>RedySmart Smart Interface Portal Software (SIP)</i> software. The setpoint and actual values can be changed in 'Signals'
Output signal is smaller than the setpoint	The gas supply is too low. The counter pressure is too high	Increase the inlet pressure. Check the valve voltage in the <i>RedySmart Smart Interface Portal Software (SIP)</i> software. This must not be > 95%. (In menue 'overview' click the button 'Graph' or in the main menu /Extras /Graph Tool)
Analog setpoint is not acquired	Incorrect electrical connection	Please check that the pin assignments are correct
	The control mode is set to 'Digital'	Change the control mode to 'Automatic' or 'Analog' in the 'Signals' window of the <i>RedySmart Smart Interface Portal Software (SIP)</i> software
	Wrong analog signal	Operate the device with the <i>RedySmart SIP</i> software. The analog setpoint and actual values and the unit can be changed in 'Signals'

Error	Possible causes	Measures
	Device is being simultaneously operated with the <i>RedySmart Smart Interface Portal Software (SIP)</i> software; digital communication has priority	Close <i>RedySmart Smart SIP</i> or change the control mode to 'Analog' in the 'Signals' window of the <i>RedySmart Smart Interface Portal Software (SIP)</i> software
Analog output stays at 4 mA or 0/1 V	Switch-on setpoint has been activated	Change the switch-on setpoint in the menu "analog signal". Below this set value, the device shows zero flow
Output signal is 21.6 mA / 5.4 or 10.8 V (only with measuring devices)	Flow is too high (Overflow)	Reduce the flow rate. If necessary, the full scale can be extended on site. Please consult your sales partner
	Device is heavily contaminated	Please consult your sales partner
	Sensor faulty	Please consult your sales partner
Flow is shown despite setpoint zero	Valve is leaking, contaminated	Flush the valve by repeated 'Valve 100%' open/close in the <i>RedySmart Smart Interface Portal Software (SIP)</i> software under 'Signals'. Please consult your sales partner
	Sensor contaminated	Please consult your sales partner
	The device is being operated with a different gas from its calibration.	For multi-gas instruments, you can set the appropriate gas type with the <i>RedySmart Smart Interface Portal Software (SIP)</i> software
	Offset due to mounting position	Particularly with small measurement ranges, heavy gases and gauge pressures > 5 bar, a zero-point offset can occur where the mounting position is vertical >> chimney effect. Where possible, mount the device horizontally
	'Power-up' setpoint is enabled	In this case the device controls to a defined setpoint as soon as it is powered with 24 V. Disable the 'power-up' setpoint or enter a setpoint value 0
No digital communication is possible	Several devices with the same address have been connected to a bus. During operation, the address of several devices was changed with the 'All address 247' button	Connect one device after another to the <i>RedySmart Smart Interface Portal Software (SIP)</i> software and assign the device addresses
	The power-supply device is too weak to power several devices simultaneously	Use a power supply with a higher power rating (see datasheet 329-3010_ml_cablePSD.pdf 'Power Supply Devices'). Please consult your sales partner

Error	Possible causes	Measures
	You are working with devices from different generations Serial number < 110,000 Industrial 3 Serial number > 110,000 Industrial 4	In mixed-mode operation, only the PDM-U digital cable with USB port can be used
	The USB-COM port has not been assigned	Assign the correct COM port in the Device Manager on your computer.
	The baud rate has been changed	Set the baudrate in your computer same as baud rate of the Redy instrument (mostly 9600)
	You are working with an interface converter that may require level matching	Refer to the connection diagram for the Industrial digital connection. Please consult your sales partner
	Faulty circuit board	Please consult your sales partner
No flow, despite the setpoint being above zero	The control mode is set incorrectly	Change the control mode to 'Automatic' in the 'Signals' menu
	There is no gas flow or pressure	Open the gas supply, or check the inlet and the outlet pressure
	The control parameters are not set correctly	In menu 'overview click the 'Graph Tool' menu, or in the main menu under Extras/'Graph Tool', a window will open with which the control parameters can be reset. As shipped from the factory, the parameters are already set  Default settings: N = 2000 KP = 1000 Ki = 600 Kd = 0
After about 10 seconds, the controller 'clicks' clearly audibly at short intervals	There is no gas flow, although a setpoint is being applied	Ensure that gas can flow; check the inlet and outlet pressure. The valve will close to prevent overheating and with every click it opens for a second to see if there is flow possible.
Control is unstable	Pressure reducer is faulty, not suitable for the control range, or of poor quality	Use a buffer volume after the pressure reducer as a buffer, or obtain a suitable pressure reducer
	Process pressure fluctuates greatly	Use a buffer volume after the pressure reducer.

Error	Possible causes	Measures
	Gas supply with pulsating pump	Use a buffer volume after the pump as a buffer, or choose a pulsation-free pump.
	Outlet pressure too high	Check your process pressures before and after the device
	Buffer volume is too small	Use a larger buffer volume between the pressure controller and the MFC or behind the MFC.
	Power-supply device is faulty or not suitable	Try it with another power supply
	Control parameters are not optimal	Correct the control parameters in the 'Graph Tool' menu in RedySmart Smart Interface Portal Software (SIP) software as follows: In the case of excessive overshoot: <u>reduce Kp</u> Too slow: <u>increase Kp</u> General oscillation: <u>reduce Ki</u>
	Contamination	Flush the valve by repeated 'Valve 100%' open/close in the <i>RedySmart Smart Interface Portal Software (SIP)</i> software under 'Signals'. Please consult your sales partner
	Wrong flow direction	Please check the flow-direction indicator on the back of the body
Potential differences	Please refer to the 'Grounding' section in the guide	
Flow rate does not meet expectations	Leakage	Flow rate > than reference Leakage between measuring device and your reference Flow rate < than reference Leakage upstream of the measuring instrument
	Contamination	With contamination by sealing tape, for example, it is possible that the flow divider is partially blocked. In this case the device displays more than the reference. Please consult your sales partner
	The device is being operated with a different gas than calibrated.	Connect the intended gas, or change the type of gas in the 'Calibration' menu
	Inlet pressure is too low	Check your inlet and outlet pressures
Device becomes very warm	There is a setpoint signal at the flow controller, although no gas is connected	- check the pressure in your gas supply - set the setpoint to zero or enable the 'detector behavior' in the <i>RedySmart Smart</i>

Error	Possible causes	Measures
		<i>Interface Portal Software (SIP)</i> software (default setting for new device)
Valve opens to 100% with each setpoint, no flow is displayed or the displayed flow remains constant	Sensor is faulty	Please consult your sales partner
Pulsating control after setpoint is applied	Wrong flow direction	Please note the flow-direction indicator on the back of the body

## 6.13 Pressure loss

The following figures show the pressure drop of a GIM (measuring instrument)

Type A, B, C, D relates to the built-in GIM flow divider. See p.23

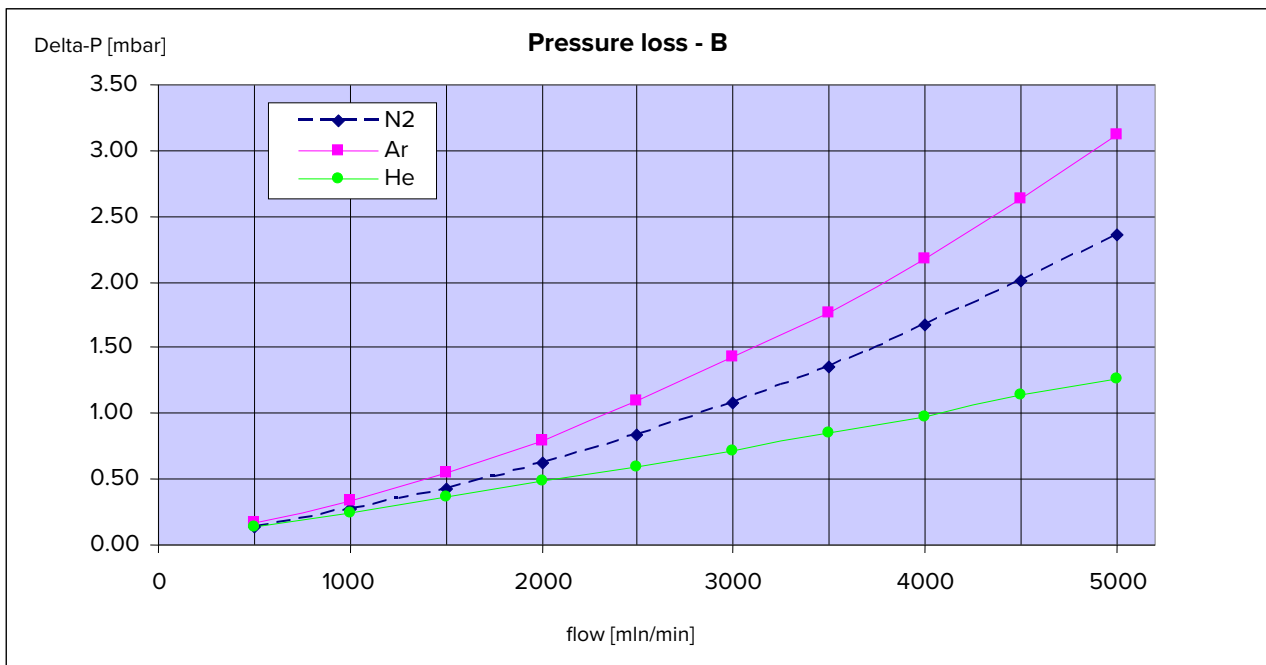
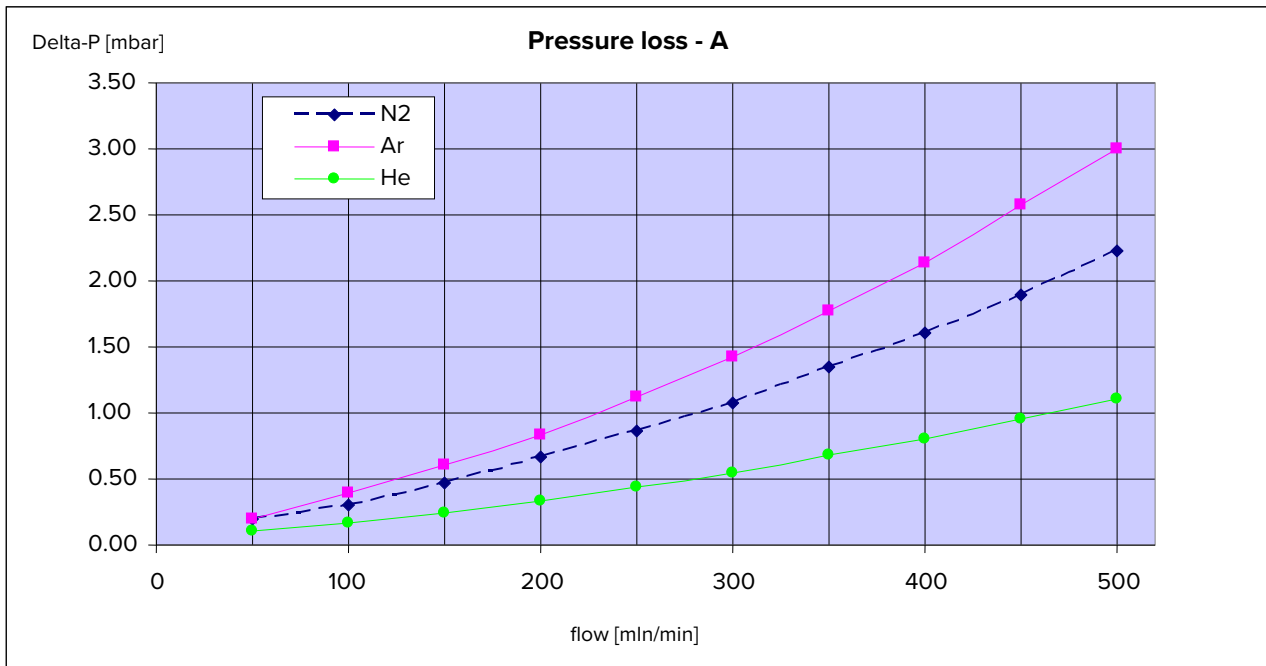

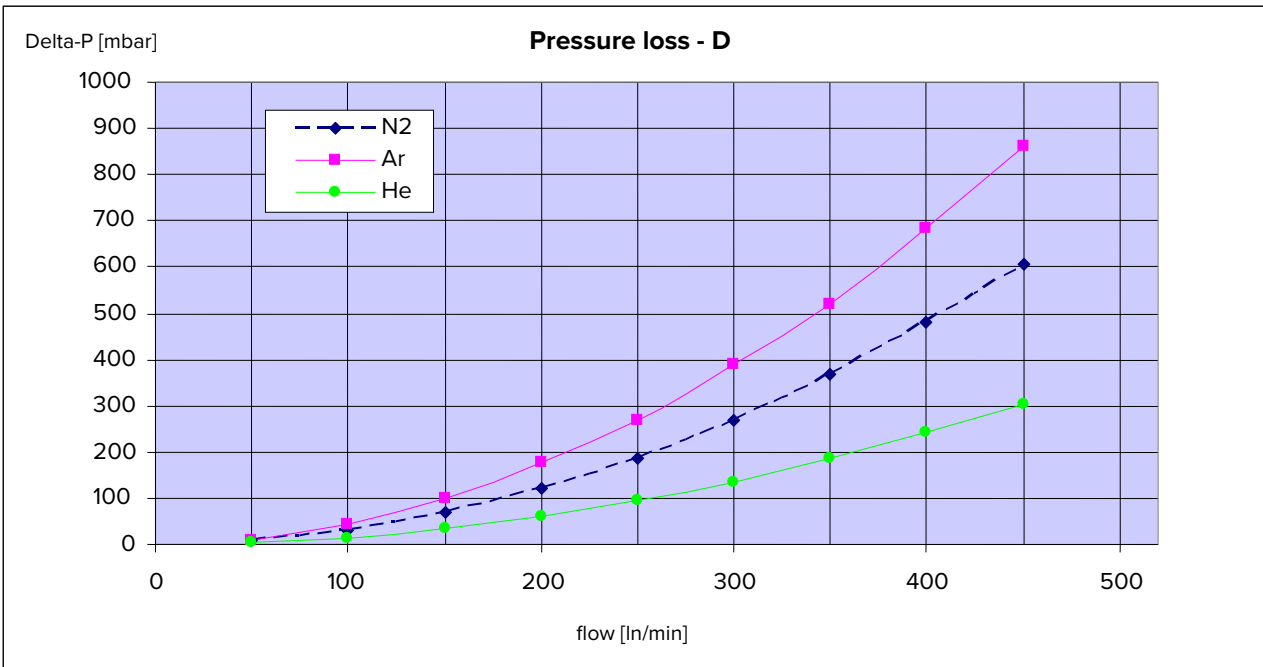
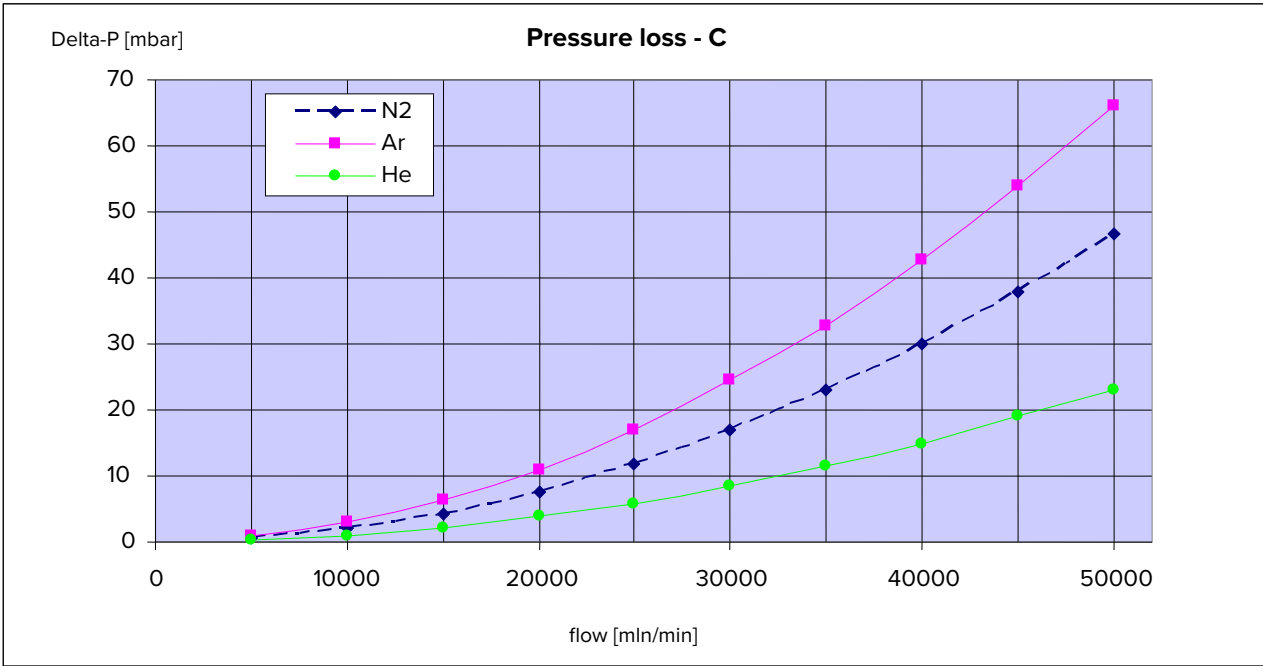



## 6.14 Dimensional drawings in mm

GIM/GIC, types A, B, C

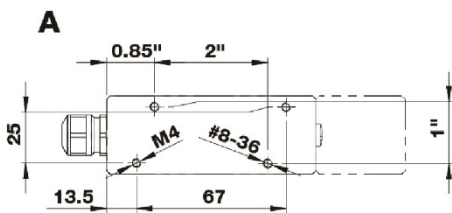
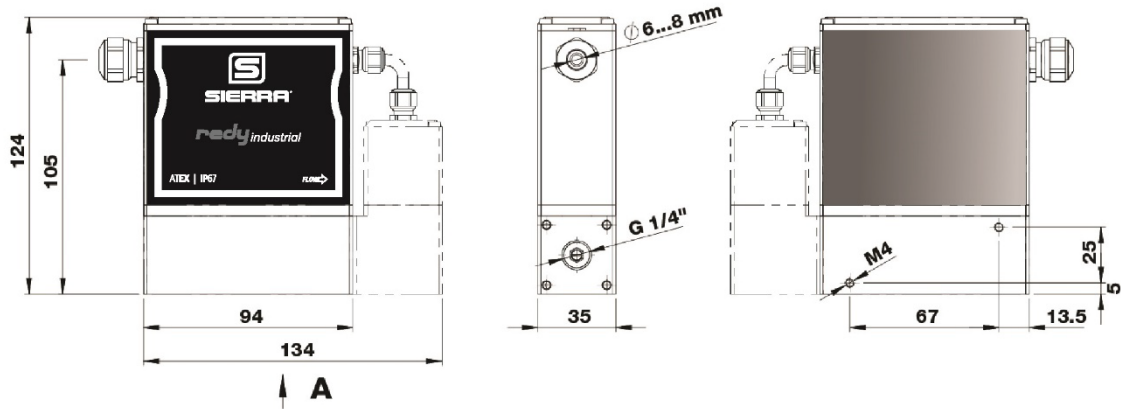

On the bottom of the unit there are 2 different threads diagonally opposite each other. Two are Metric M4. The other are UNC #8-36

GIM/GIC, type D

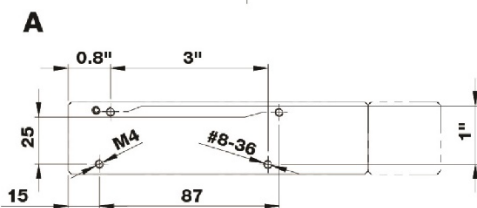
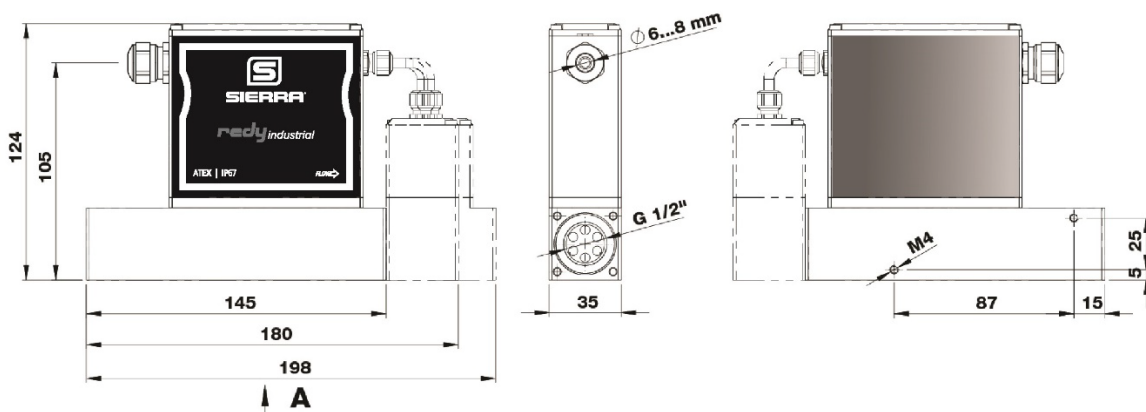

On the bottom of the unit there are 2 different threads diagonally opposite each other. Two are Metric M4. The other are UNC #8-36

GIM/GIC Electrical connection option dimensions in mm

Option with cable gland

Power / Analog/ Modbus

with Profibus (Option)

with EtherNET (option)

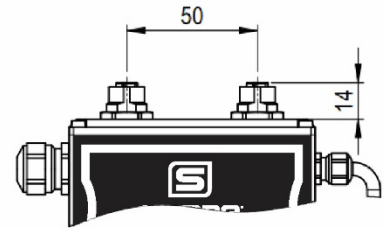
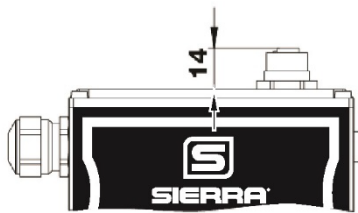
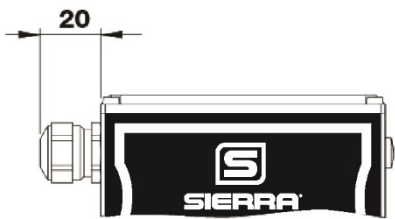

Option with M12 connector

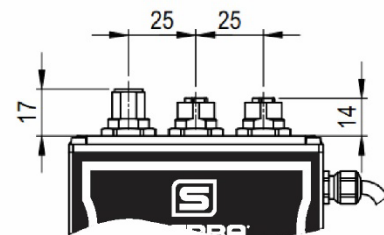
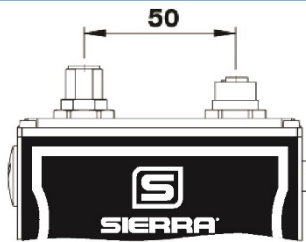
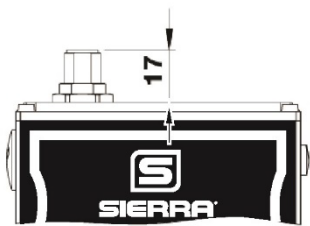

## 7.15 Dimensional drawings in inches

### GIM/GIC, types A, B, C

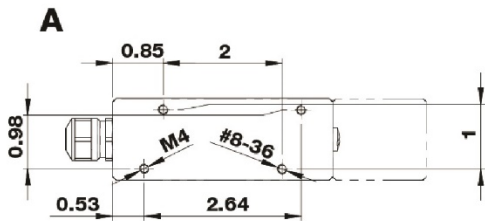
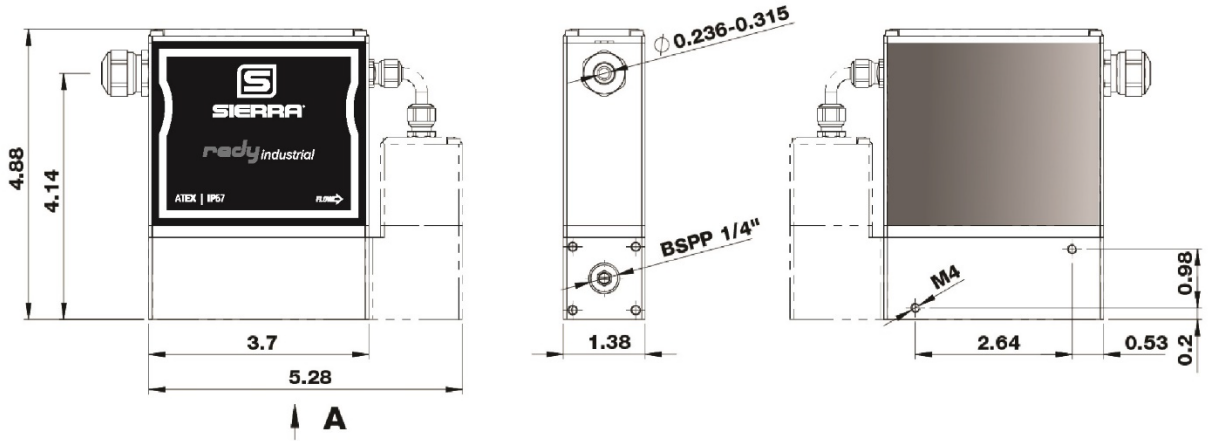

On the bottom of the unit there are 2 different threads diagonally opposite each other. Two are Metric M4. The other are UNC #8-36

### GIM/GIC, type D

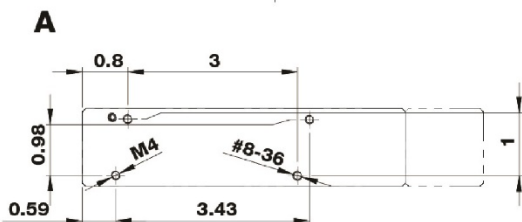
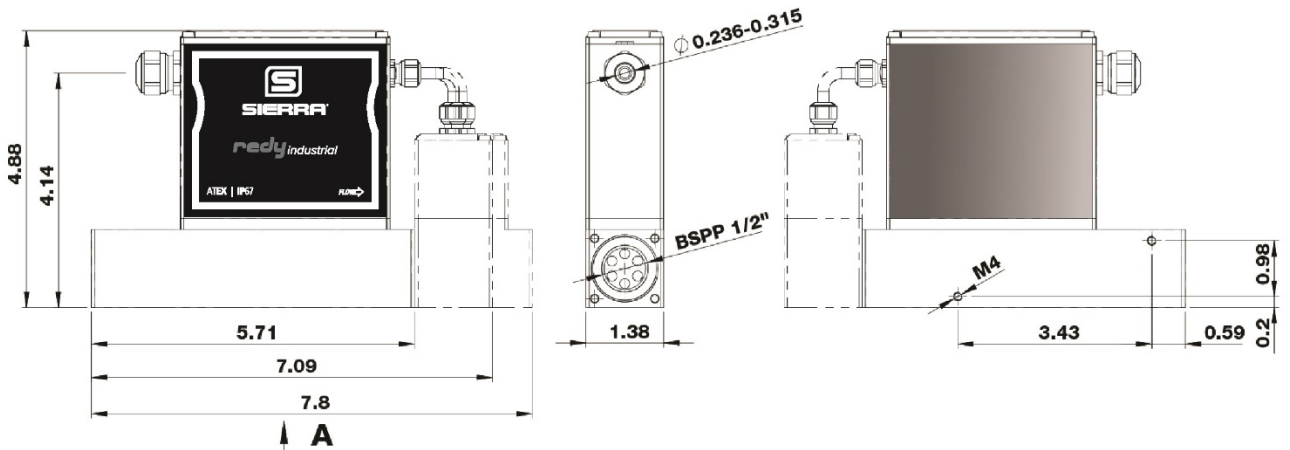

On the bottom of the unit there are 2 different threads diagonally opposite each other. Two are Metric M4. The other are UNC #8-36

GIM/GIC Electrical connection option dimensions in inch

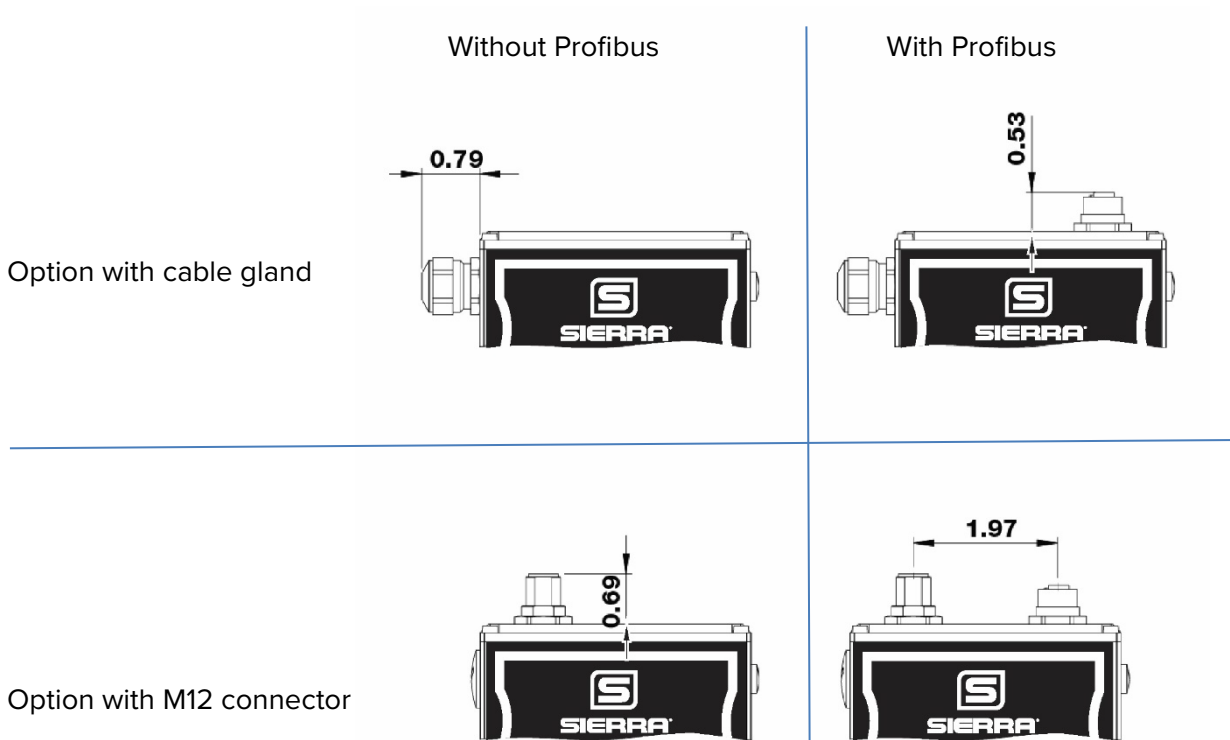

You can find detailed information for the individual products on website

[www.sierrainstruments.com](http://www.sierrainstruments.com).

If additional information is needed, please contact Sierra.

## 6.16 Communication Cable PDM-U

### Driver installation

If you install the RedySmart Smart Interface Portal Software (SIP) software, the driver will automatically be installed. Below the procedure if you do not install the RedySmart Smart Interface Portal Software (SIP) software.

- ⇒ The driver can be found on our website  
<https://www.sierrainstruments.com/products/downloads/redyindustrial>
- ⇒ Connect the communication cable to the USB port.
- ⇒ Windows will automatically detect a new **USB device** and request a driver.
- ⇒ Specify the driver location (CD-ROM or directory on hard disk)
- ⇒ If warning is displayed regarding missing driver certification, please ignore it and continue!

Installation of the communication cable is complete.

## 6.17 Type code overview

Instrument type	RedyIndustrial series (gas)	G	I			Flow splitter	Measuring range	Instrument versions	Materials (body, seals)		Analog signals (output)	Analog signals (setpoint)	Control valve (integrated)	Control valve (integrated)
Function	Meter				M									
	Controller				C									
	Controller with External valve				E									
Full scale of measuring range (air)	25 mln/min (G¼", 25 x 25 mm)					A	1							
	50 mln/min					A	2							
	100 mln/min					A	3							
	200 mln/min					A	4							
	600 mln/min					A	5							
	Customer-specific (divider A, up to 600 mln/min)					A	9							
	500 mln/min (G¼", 25 x 25 mm)					B	2							
	1'000 mln/min					B	3							
	2'000 mln/min					B	4							
	6000 mln/min					B	5							
	Customer-specific (divider B up to 6000 mln/min)					B	9							
	5 ln/min (G½", 25 x 25 mm)					C	2							
	10 ln/min					C	3							
	20 ln/min					C	4							
	60 ln/min					C	5							
	Customer-specific (divider C, up to 60 ln/min)					C	9							
	50 ln/min (G½", 35 x 35 mm)					D	2							
	100 ln/min					D	3							
	200 ln/min					D	4							
	450 ln/min					D	5							
	Customer-specific (divider D up to 450 ln/min)					D	9							
Instrument versions	Standard (±1.0% full scale, 1:50)							S						
	Hi-Performance (±0.3% full scale, ±0.5% reading, 1:100)							T						
	Customer-specific / OEM							K						
Materials (body, seals)	Cable gland / Stainless steel / EPDM (FDA)** <b>S</b>								S					
	M12 plug / Stainless steel / EPDM (FDA) <b>T</b>								T					
	Cable gland / Stainless steel / FKM <b>U</b>								U					
	M12 plug / Stainless steel / FKM <b>V</b>								V					
	Customer-specific / OEM <b>K</b>								K					

		Flow splitter	Measuring range	Instrument versions	Materials (body, seals)					Analog signals (output)	Analog signals (setpoint)	Control valve (integrated)	Control valve (integrated)
Analog signals (output)	Current 4..20 mA**										B		
	Current 0..20 mA										C		
	Voltage 0.5 V										D		
	Voltage 1.5 V										E		
	Voltage 0..10 V										F		
	Voltage 2..10 V										G		
	Customer-specific / OEM										K		
Analog signals (setpoint)	Current 4-20 mA**										B		
	Current 0-20 mA										C		
	Voltage 0-5 V										D		
	Voltage 1-5 V										E		
	Voltage 0-10 V										F		
	Voltage 2-10 V										G		
	Customer-specific										K		
Control valve (integrated)	Type 0.1											2	1
factory-set	Type 0.2											2	2
	Type 0.5											2	3
	Type 1.2											2	6
	Type 4.5											1	2
	Type 8											1	3
	Control valve not coded/defined											8	8
	Valve mounted											9	5
	Customer-specific / OEM											9	9
	No valve											0	0
Type code		G	I		-								

\*\*Standard

## 6.18 Wetted parts RedyIndustrial series

<b>Instrument Gerät</b>	<b>RedyIndustrial series</b>
Body <i>Grundkörper</i>	1.4404 (316L)
Body: O-Rings <i>Grundkörper: O-Ringe</i>	EPDM (Standard), FKM (option)
Flow divider <i>Strömungsteiler</i>	1.4305
Control valve <i>Regelventil</i>	1.4305/1.4105/1.6908
Control valve: O-Rings <i>Regelventil: O-Ringe</i>	EPDM (Standard), FKM (option)
Sensor material <i>Sensormaterialien</i>	Silicon, silicon oxide, silicon nitride <i>Silizium, Siliziumoxid, Siliziumnitrit</i> Epoxy
Sensor packaging	1.4305

<b>Abbreviation Kurzbezeichnung</b>	<b>Designation Bezeichnung</b>	<b>Remarks Bemerkungen</b>
EPDM	–	Ethylene-propylene-diene-monomer rubber Ethylen-Propylen-Dien-Kautschuk
Epoxy	–	Adhesive for sensor fixation, protection for wire bonding Klebstoff für Sensorfixierung, Schutz für Bonddrähte
FKM	–	Fluor rubber Fluor-Kautschuk

With the exception of the EQP (Valve 4.5 and 8) valve unit, it is possible to get a FDA compatible materials statement. Please contact the factory for additional information.



## 6.19 Contamination clarification

<p>When returning equipment to us, please complete all sections of the following declaration. In particular, the reason for return, in the case of contamination the nature of the residues and the cleaning, as well as information on any possible hazards.</p>	
<b>Devices</b>	
Model code:	
Serial number:	
<b>Reason for return:</b>	
<b>Type of contamination</b>	
Device was in contact with:	
It was cleaned by us with:	
<p>To protect our employees and for general safety during transport, it is vital to clean devices properly and to use appropriate packaging.</p>	
Can you provide further information on the contamination?	Inert (no hazard) Corrosive Caustic/acid Must not come into contact with moisture Oxidizing Toxic Other hazards: _____
<b>Legally binding declaration</b>	
<p>We hereby confirm the correctness and completeness of the above information.</p>	
Company:	
Address:	
Phone:	
Contact person:	
Date:	
Signature:	

## 6.20 ATEX Zone 2 and 22

### Installation Instructions for ATEX-approved Zone 2 and 22 installations

#### 1) ATEX Details

Equipment type: Meter/Controller RedyIndustrial series GI\*  
 Manufactured and submitted for examination by: Vögtlin Instruments AG  
 Address: Langenhagstrasse 1  
 CH-4147 Aesch BL  
 Switzerland

Standard basis: IEC 60079-15:2005 Nonsparking 'n'  
 EN 61241-0:2006 Dust, general requirements 'D'  
 EN 61241-1:2004 Dust by enclosure 'tD'

Code for type of protection: Gas: II 3G nA IIC T4 Gc (Category 3 / Zone 2)  
 Dust: II 3D Ex tc IIIC T100°C Dc

#### 2) Description

An Industrial Mass flow meter for dry and clean gasses.

#### 3) Parameters

##### INSTRUMENT TYPES



**Industrial Meter GIM**  
Thermal Mass Flow Meter



**Industrial Controller GIC**  
Thermal Mass Controller



**Industrial Controller GIE**  
Thermal Mass Controller with External Valve

##### ACCURACY

<b>Standard</b> The economic solution	Accuracy: $\pm 1.0\%$ of full scale(1) Turndown ratio: 1 : 50
<b>High Accuracy</b> With highest accuracy and turndown ratio (available for GIM < 200 lN/min / GIC < 150 lN/min (air))	Accuracy: $\pm 0.3\%$ of full scale + $\pm 0.5\%$ of reading(1) Turndown ratio: 1 : 100 <sup>1</sup> An additional error of $\pm 0.25\%$ may apply for analogue signals

##### MEASURING RANGES

(Air/Full Scale Freely Selectable)	Type	Measuring Range (Air)		Process Connection
RedyIndustrial Meter GIM	GIM-A	from 0 ... 25 mlN/min	to 0 ... 600 mlN/min	G $\frac{1}{4}$ "
	GIM-B	from 0 ... 600 mlN/min	to 0 ... 6000 mlN/min	G $\frac{1}{4}$ "
	GIM-C	from 0 ... 6 lN/min	to 0 ... 60 lN/min	G $\frac{1}{4}$ "
	GIM-D	from 0 ... 60 lN/min	to 0 ... 450 lN/min	G $\frac{1}{2}$ "
RedyIndustrial Controller GIC	GIM-A	from 0 ... 25 mlN/min	to 0 ... 600 mlN/min	G $\frac{1}{4}$ "
	GIM-B	from 0 ... 600 mlN/min	to 0 ... 6000 mlN/min	G $\frac{1}{4}$ "
	GIM-C	from 0 ... 6 lN/min	to 0 ... 60 lN/min	G $\frac{1}{4}$ "
	GIM-D	from 0 ... 60 lN/min	to 0 ... 450 lN/min	G $\frac{1}{2}$ "

PERFORMANCE DATA	
Gases (real gas calibration)	Air, O <sub>2</sub> <sup>(2)</sup> , N <sub>2</sub> <sup>(2)</sup> , He, Ar, CO <sub>2</sub> , H <sub>2</sub> , CH <sub>4</sub> , C <sub>3</sub> H <sub>8</sub> (other gases and gas mixtures on request) <sup>2</sup> O <sub>2</sub> & N <sub>2</sub> are calibrated with Air
Response Time	Meter (GIM): ± 80ms(3); Controller (GIC): ± 500ms(3) 3 depending on device configuration & according to SEMI standard E17-1011, 5-100% of range under optimized conditions
Repeatability	± 0.2% of full scale (according to SEMI standard E56-0309)
Longterm Stability	< 1% of measured value / year
Power Supply	24 Vdc (18 – 30 Vdc), 15 Vdc on request
Current Consumption Standard	Meter (GIM): max. 100mA; Controller (GIC): max. 250mA (GIC with valve type 8 max. 490mA)
Current Consumption Profinet RT / EtherCAT	Meter (GIM): max. 100mA; Controller (GIC): max. 340mA (GIC with valve type 8 max. 560mA)
Operation Pressure	0.2 – 11 bar a (GIC with valve type 4.5 and 8 max. 8 bar a)
Temperature (Environment/Gas)	0 – 50°C
Pressure Sensitivity	Less than 0.2% RD per bar (typical N <sub>2</sub> )
Temperature Sensitivity	Less than 0.025% FS per °C (typical N <sub>2</sub> )
Warm-up Time	< 1 sec. for full accuracy
MATERIALS	
Body	Stainless steel 316L (see operating instructions for wetted parts)
Electronic Housing	Aluminum
Seals	EPDM (FDA), optional FKM and FFKM
INTEGRATION	
In- / Output Signals Analog	0..20 mA, 4..20 mA, 0..5 V, 1..5 V, 0..10 V, 2..10 V
In- / Output Signals Digital	RS-485; Modbus RTU 2 wire (Slave); Lab View-VIs available Option: Profibus DP-V0, DP-V1 / Profinet RT / EtherCAT
Process Connection	G <sup>1</sup> / <sub>4</sub> " (BSPP(4) female) up to 60 l/min, G <sup>1</sup> / <sub>2</sub> " (BSPP(4) female) up to 450 l/min 4 British Standard Pipe Parallel
Inlet Section	None required
Electrical Connection	Cable gland with compression fitting M16x1.5 / Option: M12 plug (DIN-standard) (both connection IP67 protected)
Mounting Orientation	All orientations are possible. We recommend horizontal mounting. Please contact the manufacturer for further information.
SAFETY	
Test pressure	16 bara
Leak rate	< 1 x 10 <sup>-6</sup> mbar l/s He
Ingress Protection Class	IP67 (conforms to NEMA 6)
EMC	CE EN 61326-1
ATEX Certification <sup>(5)</sup>	Ex II 3G nA IIC T4 Gc (Category 3 / Zone 2) Ex II 3D Ex tc IIIC T100°C Dc (Category 3 / Zone 22)

<sup>5</sup> Profinet RT & EtherCAT option not yet ATEX certified. Please contact your sales partner for further information.

#### 4) Marking

Gas: II 3G nA IIC T4 Gc

Dust: II 3D Ex tc IIIC T100°C Dc

#### Special conditions for safe use / Installation instructions

- The permissible ambient temperature range for the transmitter is 0 °C up to +50 °C.
- The cable entries or conduit entries shall have a degree of protection of at least IP54 for use in category 3G. (Higher rating if the environment demands this)
- The terminals must not be disconnected unless the unit has been de-energized or the area is known to be safe.
- Special conditions for safe use for transmitters with plug sockets:  
The plug must be suitable for the plug socket type M12. The plug must fulfill the requirements of Category 3G independent of the use in Zone 2 or Zone 22.
- The plugs must assure in the plugged and screwed status the type of protection IP67 in accordance to EN 60529 for the contacts.
- The plug must be equipped with a securing element in accordance to EN 61241-0, clause 19.1.b), which can only be removed with a tool, to prevent an unintentional disconnection.
- If the plug socket is not connected with a plug, the plug socket is to be protected against water and dust in minimum IP 67 in accordance to EN 60529. Before the plug socket will be connected to a plug it must be guaranteed that there is no dust or water in the plug and the plug socket.
- The operator shall provide external protection to prevent transient disturbances of more than 10% of the rated voltage of the plug sockets.



## Declaration of Conformity

Sierra Instruments, Inc.  
5 Harris Court, Building L  
Monterey, CA 93940

Sierra Instruments certifies that the products:

RedyIndustrial Meter GIM<sup>2</sup> / Mass Flow Meter  
RedyIndustrial Controller GIC<sup>2</sup> / Mass Flow Controller

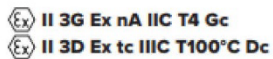

<sup>2</sup>All various versions.

Comply with the regulations of the following European Directives:

**EMC-directive 2014/30/EU**  
**Ex-directive 2014/34/EU**

Conformity is demonstrated by compliance with the following standards and normative documents:

EN55011 (2009) + A1 (2010)  
EN61000-3-2 (2006) + A1 (2009) + A2 (2009)  
EN61000-3-3 (2008)  
EN61000-4-2 (2009)  
EN61000-4-3 (2006) + A1 (2008) + A2 (2010)  
EN61000-4-4 (2012)  
EN61000-4-5 (2007)  
EN61000-4-6 (2014)  
EN61000-4-8 (2010)  
EN61326-1 (2006)  
NAMUR NE21 (2012)

*Gerald W Mullison*

Jerry Mullison, Director of Engineering  
United States, June 2023

## 6.21 Change history

Date	Version	Replaces	Author	Note
23.06.2014	EN 1.0		PdW	Initiated new Manual
02.12.2020	EN 1.2		HAE	Cable gland EtherNET (option)

# 7. Index

<b>A</b>		<b>I</b>	
Analog signals .....	15	Installation and commissioning .....	18
Appendix .....	26		
<b>B</b>		<b>M</b>	
Block diagram .....	11	Maintenance / Calibration check .....	23
		measurement principle .....	10
<b>C</b>		Measurement ranges (air) .....	13
Calibration .....	16	Mechanical specifications .....	12
Change history .....	45	Mounting position and location .....	18
Cleaning to remove contamination .....	23		
CMOS technology .....	11	<b>O</b>	
Communication cable PDM-U .....	37	Other gases .....	16
Contamination clarification .....	41		
Control behavior .....	17	<b>P</b>	
		Pipework .....	18
<b>D</b>		Plug pin assignment, PROFIBUS .....	16
Device specifications general .....	12	Pressure compensation .....	17
Digital communication .....	25	Pressure loss .....	17, 31
Dimensional drawings .....	33		
Documentation supplied .....	9	<b>R</b>	
		Response time .....	17
<b>E</b>		Return .....	24
Electrical connection .....	21		
Electrical data .....	13	<b>S</b>	
Electrical power supply .....	20	Scope of warranty .....	8
		Sealants .....	19
<b>F</b>		Serial interface .....	16
Features of thermal mass flow meters and controllers .....	8		
filter fittings .....	19	<b>T</b>	
Filters / Gas cleanliness .....	20	Technical data .....	12
Flow splitter disassembly .....	24	Temperature compensation .....	17
Functions get red-y .....	25	Troubleshooting flow rate .....	26
		Type code GSM / GSC .....	38
<b>G</b>			
<i>get red-y</i> software .....	25	<b>W</b>	
Grounding .....	22	Warm-up time .....	23
		Wetted parts .....	40